

EDS-611 Series

8+3G-port compact modular managed Ethernet switches



Features and Benefits

- Modular design with 4-port copper/fiber combinations
- Hot-swappable media modules for continuous operation
- Turbo Ring and Turbo Chain (recovery time < 20 ms @ 250 switches),¹ RSTP/STP, and MSTP for network redundancy
- TACACS+, SNMPv3, IEEE 802.1X, HTTPS, and SSH to enhance network security
- Easy network management by web browser, CLI, Telnet/serial console, Windows utility, and ABC-01
- Supports MXstudio for easy, visualized industrial network management

Certifications

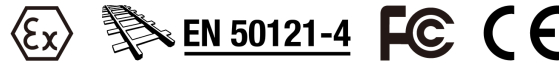

Introduction

The versatile modular design of the compact EDS-611 Series allows users to combine fiber and copper modules to create switch solutions suitable for any automation network. The EDS-611's modular design lets you install up to 3 Gigabit Ethernet ports and 8 Fast Ethernet ports, and the advanced Turbo Ring and Turbo Chain (recovery time < 20 ms) technology, RSTP/STP, and MSTP help increase the reliability and availability of your industrial Ethernet network.

Models with an extended operating temperature range of -40 to 75°C are also available. The EDS-611 Series supports several reliable and intelligent functions, including IEEE 1588 PTPv2, EtherNet/IP, Modbus TCP, LLDP, DHCP Option 82, SNMP Inform, QoS, IGMP snooping, VLAN, TACACS+, IEEE 802.1X, HTTPS, SSH, SNMPv3, and more, making the Ethernet switches suitable for any harsh industrial environment.

Additional Features and Benefits

- Command line interface (CLI) for quickly configuring major managed functions
- SNMP Inform for ensuring reliable event management
- LLDP for automated topology discovery
- DHCP Option 82 for IP address assignment with different policies
- Software-based IEEE 1588 PTPv2 (Precision Time Protocol) for time synchronization of networks
- Supports EtherNet/IP and Modbus TCP protocols for device management and monitoring
- Compatible with PROFINET protocol for transparent data transmission
- Lock port function for blocking unauthorized access based on MAC address
- IGMP snooping and GMRP for filtering multicast traffic
- Port-based VLAN, IEEE 802.1Q VLAN, and GVRP to ease network planning
- QoS (IEEE 802.1p/1Q and TOS/DiffServ) to increase determinism
- Port Trunking for optimum bandwidth utilization
- SNMPv1/v2c/v3 for different levels of network management
- RMON for proactive and efficient network monitoring
- Bandwidth management to prevent unpredictable network status
- Automatic warning by exception through email and relay output
- Port mirroring for online debugging

Specifications

Input/Output Interface

Digital Inputs	+13 to +30 V for state 1 -30 to +3 V for state 0 Max. input current: 8 mA
Alarm Contact Channels	Relay output with current carrying capacity of 1 A @ 24 VDC

1. Gigabit Ethernet recovery time < 50 ms

Ethernet Interface

Module	2 slots for any combination of 4-port interface modules, 10/100BaseT(X) or 100BaseFX
Standards	IEEE 802.1D-2004 for Spanning Tree Protocol IEEE 802.1p for Class of Service IEEE 802.1Q for VLAN Tagging IEEE 802.1s for Multiple Spanning Tree Protocol IEEE 802.1w for Rapid Spanning Tree Protocol IEEE 802.1X for authentication IEEE 802.3 for 10BaseT IEEE 802.3ab for 1000BaseT(X) IEEE 802.3ad for Port Trunk with LACP IEEE 802.3u for 100BaseT(X) and 100BaseFX IEEE 802.3x for flow control

Ethernet Software Features

Filter	GMRP, GVRP, IGMP v1/v2, Port-based VLAN
Industrial Protocols	EtherNet/IP, Modbus TCP
Management	Back Pressure Flow Control, BOOTP, DDM, DHCP Option 66/67/82, DHCP Server/Client, Flow control, IPv4/IPv6, LLDP, Port Mirror, RARP, RMON, SMTP, SNMP Inform, SNMPv1/v2c/v3, Syslog, Telnet, TFTP
MIB	Bridge MIB, Ethernet-like MIB, MIB-II, P-BRIDGE MIB, Q-BRIDGE MIB, RMON MIB Groups 1, 2, 3, 9, RSTP MIB
Redundancy Protocols	Link Aggregation, MSTP, RSTP, STP, Turbo Chain, Turbo Ring v1/v2
Security	Broadcast storm protection, HTTPS/SSL, Port Lock, RADIUS, SSH, TACACS+
Time Management	NTP Server/Client, SNTP

Switch Properties

IGMP Groups	256
MAC Table Size	8 K
Max. No. of VLANs	64
Packet Buffer Size	1 Mbits
Priority Queues	4
VLAN ID Range	VID 1 to 4094

LED Interface

LED Indicators	PWR1, PWR2, FAULT, MSTR/HEAD, CPLR/TAIL, G1/G2/G3
----------------	---

Serial Interface

Console Port	RS-232 (TxD, RxD, GND), 8-pin RJ45 (115200, n, 8, 1)
--------------	--

DIP Switch Configuration

Ethernet Interface	Turbo Ring, Master, Coupler, Reserve
--------------------	--------------------------------------

Power Parameters

Connection	1 removable 6-contact terminal block(s)
Input Voltage	12/24/48 VDC, Redundant dual inputs
Overload Current Protection	Supported
Reverse Polarity Protection	Supported

Physical Characteristics

IP Rating	IP30
Dimensions	124.9 x 151 x 157.2 mm (4.92 x 5.95 x 6.19 in)
Weight	2260 g (4.99 lb)
Installation	DIN-rail mounting, Wall mounting (with optional kit)

Environmental Limits

Operating Temperature	EDS-611: 0 to 60°C (32 to 140°F) EDS-611-T: -40 to 75°C (-40 to 167°F)
Storage Temperature (package included)	-40 to 85°C (-40 to 185°F)
Ambient Relative Humidity	5 to 95% (non-condensing)

Standards and Certifications

Freefall	IEC 60068-2-32
EMC	EN 55032/24, EN 61000-6-2/-6-4
EMI	CISPR 32, FCC Part 15B Class A
EMS	IEC 61000-4-2 ESD: Contact: 6 kV; Air: 8 kV IEC 61000-4-3 RS: 80 MHz to 1 GHz: 10 V/m IEC 61000-4-4 EFT: Power: 2 kV; Signal: 1 kV IEC 61000-4-5 Surge: Power: 2 kV; Signal: 2 kV IEC 61000-4-6 CS: 10 V IEC 61000-4-8 PFMF
Hazardous Locations	ATEX, Class I Division 2
Maritime	ABS, DNV-GL, LR, NK
Railway	EN 50121-4
Safety	EN 60950-1, UL 508, UL 60950-1
Shock	IEC 60068-2-27
Traffic Control	NEMA TS2
Vibration	IEC 60068-2-6

MTBF

Time	483,344 hrs
Standards	Telcordia (Bellcore), GB

Warranty

Warranty Period	5 years
-----------------	---------

Package Contents

Device	1 x EDS-611 Series switch
Cable	1 x RJ45-to-DB9 console cable

Documentation	1 x document and software CD 1 x product certificates of quality inspection, Simplified Chinese 1 x product notice, Simplified Chinese 1 x quick installation guide 1 x warranty card
Note	SFP modules and/or modules from the CM-600 Module Series need to be purchased separately for use with this product.

Dimensions

Unit: mm (inch)

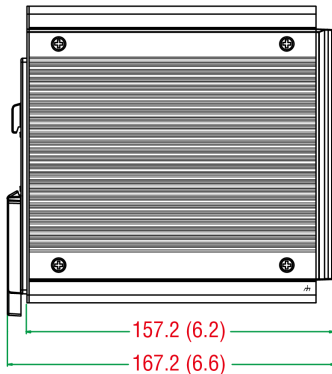

Side View

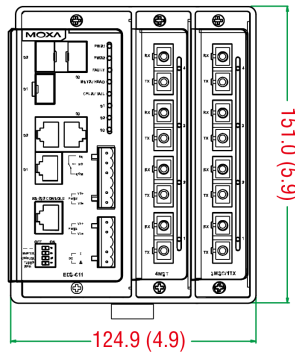

Front View

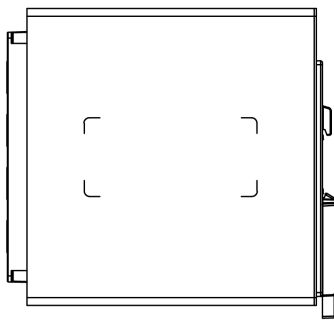

Side View

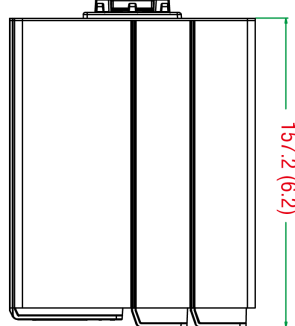

Top View

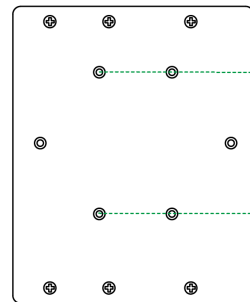

Rear View

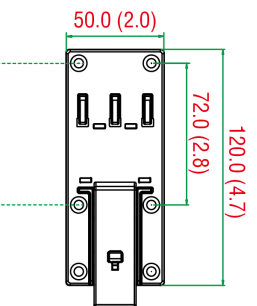

DIN-Rail Mounting Kit

Ordering Information

Model Name	Layer	Total No. of Ports	Module 10/100BaseT(X) and/or 100BaseFX	Combo Ports 10/100/1000BaseT(X) or 100/1000BaseSFP	Operating Temp.
EDS-611	2	11	2 slots for up to 8 10/100BaseT(X) and/or 100BaseFX ports	3	0 to 60°C
EDS-611-T	2	11	2 slots for up to 8 10/100BaseT(X) and/or 100BaseFX ports	3	-40 to 75°C

Accessories (sold separately)

CM-600 Module Series

CM-600-4TX	Fast Ethernet interface module with 4 10/100BaseT(X) ports, RJ45 connectors, -40 to 75°C operating temperature
CM-600-4TX-BP	Fast Ethernet interface module with 4 10/100BaseT(X) ports, RJ45 connectors, bypass support, -40 to 75°C operating temperature
CM-600-4TX-PTP	Fast Ethernet interface module with 4 10/100BaseT(X) ports, RJ45 connectors, IEEE 1588 PTP V2 protocol support, -40 to 75°C operating temperature

CM-600-4MSC	Fast Ethernet interface module with 4 100BaseFX multi-mode ports, SC connectors, -40 to 75°C operating temperature
CM-600-4MST	Fast Ethernet interface module with 4 100BaseFX multi-mode ports, ST connectors, -40 to 75°C operating temperature
CM-600-4SSC	Fast Ethernet interface module with 4 100BaseFX single-mode ports, SC connectors, -40 to 75°C operating temperature
CM-600-3MSC/1TX	Fast Ethernet interface module with 1 10/100BaseT(X) port, RJ45 connector, and 3 100BaseFX multi-mode ports, SC connectors, -40 to 75°C operating temperature
CM-600-3MST/1TX	Fast Ethernet interface module with 1 10/100BaseT(X) port, RJ45 connector, and 3 100BaseFX multi-mode ports, ST connectors, -40 to 75°C operating temperature
CM-600-3SSC/1TX	Fast Ethernet interface module with 1 10/100BaseT(X) port, RJ45 connector, and 3 100BaseFX single-mode ports, SC connectors, -40 to 75°C operating temperature
CM-600-2MSC/2TX	Fast Ethernet interface module with 2 10/100BaseT(X) ports, RJ45 connectors, and 2 100BaseFX multi-mode ports, SC connectors, -40 to 75°C operating temperature
CM-600-2MST/2TX	Fast Ethernet interface module with 2 10/100BaseT(X) ports, RJ45 connectors, and 2 100BaseFX multi-mode ports, ST connectors, -40 to 75°C operating temperature
CM-600-2SSC/2TX	Fast Ethernet interface module with 2 10/100BaseT(X) ports, RJ45 connectors, and 2 100BaseFX single-mode ports, SC connectors, -40 to 75°C operating temperature

Software

MXview	Industrial network management software designed for converged automation networks
--------	---

Storage Kits

ABC-01	Configuration backup and restoration tool for managed Ethernet switches and AWK Series wireless APs/bridges/clients, 0 to 60°C operating temperature
--------	--

SFP Modules

SFP-1FELLC-T	SFP module with 1 100Base single-mode with LC connector for 80 km transmission, -40 to 85°C operating temperature
SFP-1FEMLC-T	SFP module with 1 100Base multi-mode with LC connector for 4 km transmission, -40 to 85°C operating temperature
SFP-1FESLC-T	SFP module with 1 100Base single-mode with LC connector for 40 km transmission, -40 to 85°C operating temperature
SFP-1G10ALC	WDM-type (BiDi) SFP module with 1 1000BaseSFP port with LC connector for 10 km transmission; TX 1310 nm, RX 1550 nm, 0 to 60°C operating temperature
SFP-1G10ALC-T	WDM-type (BiDi) SFP module with 1 1000BaseSFP port with LC connector for 10 km transmission; TX 1310 nm, RX 1550 nm, -40 to 85°C operating temperature
SFP-1G10BLC	WDM-type (BiDi) SFP module with 1 1000BaseSFP port with LC connector for 10 km transmission; TX 1550 nm, RX 1310 nm, 0 to 60°C operating temperature
SFP-1G10BLC-T	WDM-type (BiDi) SFP module with 1 1000BaseSFP port with LC connector for 10 km transmission; TX 1550 nm, RX 1310 nm, -40 to 85°C operating temperature
SFP-1G20ALC	WDM-type (BiDi) SFP module with 1 1000BaseSFP port with LC connector for 20 km transmission; TX 1310 nm, RX 1550 nm, 0 to 60°C operating temperature
SFP-1G20ALC-T	WDM-type (BiDi) SFP module with 1 1000BaseSFP port with LC connector for 20 km transmission; TX 1310 nm, RX 1550 nm, -40 to 85°C operating temperature
SFP-1G20BLC	WDM-type (BiDi) SFP module with 1 1000BaseSFP port with LC connector for 20 km transmission; TX 1550 nm, RX 1310 nm, 0 to 60°C operating temperature
SFP-1G20BLC-T	WDM-type (BiDi) SFP module with 1 1000BaseSFP port with LC connector for 20 km transmission; TX 1550 nm, RX 1310 nm, -40 to 85°C operating temperature
SFP-1G40ALC	WDM-type (BiDi) SFP module with 1 1000BaseSFP port with LC connector for 40 km transmission; TX 1310 nm, RX 1550 nm, 0 to 60°C operating temperature
SFP-1G40ALC-T	WDM-type (BiDi) SFP module with 1 1000BaseSFP port with LC connector for 40 km transmission; TX 1310 nm, RX 1550 nm, -40 to 85°C operating temperature
SFP-1G40BLC	WDM-type (BiDi) SFP module with 1 1000BaseSFP port with LC connector for 40 km transmission; TX 1550 nm, RX 1310 nm, 0 to 60°C operating temperature

SFP-1G40BLC-T	WDM-type (BiDi) SFP module with 1 1000BaseSFP port with LC connector for 40 km transmission; TX 1550 nm, RX 1310 nm, -40 to 85°C operating temperature
SFP-1GEZXC	SFP module with 1 1000BaseEZC port with LC connector for 110 km transmission, 0 to 60°C operating temperature
SFP-1GEZXC-120	SFP module with 1 1000BaseEZC port with LC connector for 120 km transmission, 0 to 60°C operating temperature
SFP-1GLHLC	SFP module with 1 1000BaseLH port with LC connector for 30 km transmission, 0 to 60°C operating temperature
SFP-1GLHLC-T	SFP module with 1 1000BaseLH port with LC connector for 30 km transmission, -40 to 85°C operating temperature
SFP-1GLHXC	SFP module with 1 1000BaseLHX port with LC connector for 40 km transmission, 0 to 60°C operating temperature
SFP-1GLHXC-T	SFP module with 1 1000BaseLHX port with LC connector for 40 km transmission, -40 to 85°C operating temperature
SFP-1GLSXC	SFP module with 1 1000BaseLSX port with LC connector for 500 m transmission, 0 to 60°C operating temperature
SFP-1GLSXC-T	SFP module with 1 1000BaseLSX port with LC connector for 500 m transmission, -40 to 85°C operating temperature
SFP-1GLXC	SFP module with 1 1000BaseLX port with LC connector for 10 km transmission, 0 to 60°C operating temperature
SFP-1GLXC-T	SFP module with 1 1000BaseLX port with LC connector for 10 km transmission, -40 to 85°C operating temperature
SFP-1GSXC	SFP module with 1 1000BaseSX port with LC connector for 300/550 m transmission, 0 to 60°C operating temperature
SFP-1GSXC-T	SFP module with 1 1000BaseSX port with LC connector for 300/550 m transmission, -40 to 85°C operating temperature
SFP-1GZXC	SFP module with 1 1000BaseZX port with LC connector for 80 km transmission, 0 to 60°C operating temperature
SFP-1GZXC-T	SFP module with 1 1000BaseZX port with LC connector for 80 km transmission, -40 to 85°C operating temperature
SFP-1GTXRJ45-T	SFP module with 1 1000BaseT port with RJ45 connector for 100 m transmission, -40 to 75°C operating temperature

Power Supplies

DR-120-24	120W/2.5A DIN-rail 24 VDC power supply with universal 88 to 132 VAC or 176 to 264 VAC input by switch, or 248 to 370 VDC input, -10 to 60°C operating temperature
DR-4524	45W/2A DIN-rail 24 VDC power supply with universal 85 to 264 VAC or 120 to 370 VDC input, -10 to 50°C operating temperature
DR-75-24	75W/3.2A DIN-rail 24 VDC power supply with universal 85 to 264 VAC or 120 to 370 VDC input, -10 to 60°C operating temperature
MDR-40-24	DIN-rail 24 VDC power supply with 40W/1.7A, 85 to 264 VAC, or 120 to 370 VDC input, -20 to 70°C operating temperature
MDR-60-24	DIN-rail 24 VDC power supply with 60W/2.5A, 85 to 264 VAC, or 120 to 370 VDC input, -20 to 70°C operating temperature

Wall-Mounting Kits

WK-75	Wall-mounting kit, 2 plates, 8 screws, 75 x 90 x 2.5 mm
-------	---

Anti-Vibration Wiring Kits

AVK-17	Anti-vibration wiring kit
--------	---------------------------

© Moxa Inc. All rights reserved. Updated Nov 12, 2018.

This document and any portion thereof may not be reproduced or used in any manner whatsoever without the express written permission of Moxa Inc. Product specifications subject to change without notice. Visit our website for the most up-to-date product information.