

AWK-3131A-M12-RCC Quick Installation Guide

Moxa AirWorks

Edition 2.0, January 2019

Technical Support Contact Information www.moxa.com/support

Moxa Americas:

Toll-free: 1-888-669-2872

Tel: 1-714-528-6777

Fax: 1-714-528-6778

Moxa China (Shanghai office):

Toll-free: 800-820-5036

Tel: +86-21-5258-9955

Fax: +86-21-5258-5505

Moxa Europe:

Tel: +49-89-3 70 03 99-0

Fax: +49-89-3 70 03 99-99

Moxa Asia-Pacific:

Tel: +886-2-8919-1230

Fax: +886-2-8919-1231

Moxa India:

Tel: +91-80-4172-9088

Fax: +91-80-4132-1045

MOXA®

© 2019 Moxa Inc. All rights reserved.

P/N: 1802031312031



Overview

Moxa's new AWK-3131A-M12-RCC is a 3-in-1 industrial AP/client device designed specifically for rail carriage-to-carriage communication and can provide up to 300 Mbps speed with IEEE 802.11n technology. The AWK-3131A-M12-RCC combines two adjacent 20 MHz channels into a single 40 MHz channel to deliver a potent combination of greater reliability and more bandwidth. The dual DC power inputs increase the reliability of the power supply, and the AWK-3131A-M12-RCC can be powered via PoE to make deployment easier. The AWK-3131A-M12-RCC can operate on either the 2.4 or 5 GHz bands and is backward-compatible with existing 802.11a/b/g deployments to future-proof your wireless investments.

Package Checklist

- AWK-3131A-M12-RCC
- Cable holder with one screw
- 2 plastic RJ45 protective caps for Console port
- DIN-rail kit (preinstalled)
- Quick installation guide (printed)
- Warranty card

If any of these items is missing or damaged, please contact your customer service representative for assistance.

NOTE Antennas are not included and should be purchased separately. The AWK is certified with 2 dBi omni-directional antennas with QMA to RP-SMA adapters.

Installation and Configuration

Before installing the AWK-3131A-M12-RCC, make sure that all items in the Package Checklist are in the box. In addition, you will need access to a notebook computer or PC equipped with an Ethernet port. The AWK-3131A-M12-RCC has a default IP address that you must use when connecting to the device for the first time.

Step 1: Select the power source

The AWK-3131A-M12-RCC can be powered by a DC power input or PoE (Power over Ethernet). The AWK-3131A-M12-RCC will use whichever power source you choose.

Step 2: Connect the AWK-3131A-M12-RCC to a notebook or PC

Since the AWK-3131A-M12-RCC supports MDI/MDI-X auto-sensing, you can use either a straight-through cable or crossover cable to connect the AWK-3131A-M12-RCC to a computer. If the LAN LED indicator on the AWK-3131A-M12-RCC port lights up, it means the connection is established.

Step 3: Set up the computer's IP address

Set an IP address on the same subnet as the AWK-3131A-M12-RCC. Since the AWK-3131A-M12-RCC's default IP address is 192.168.127.253, and the subnet mask is 255.255.255.0, you should set the IP address of the computer to 192.168.127.xxx and subnet mask to 255.255.255.0.

Step 4: Use the web-based manager to configure

AWK-3131A-M12-RCC

Open your computer's web browser and then type

http://192.168.127.253 in the address field to access the homepage of the web-based management. Before the homepage opens, you will need to enter the user name and password. For first-time configuration, enter the default user name and password and then click on the **Login** button:

Username: **admin**

Password: **moxa**



ATTENTION

For security reasons, we strongly recommend changing the password. To do so, select **Maintenance → Password**, and then follow the on-screen instructions.

Step 5: Select the operation mode for the

AWK-3131A-M12-RCC

By default, the AWK-3131A-M12-RCC's operation mode is set to AP. You can change the setting in **Wireless Settings → Basic Wireless Settings** if you would like to use the Client mode.

NOTE To make the change effective, you must click Save Configuration to save the change or the Save and Restart button to apply all changes.

Panel Layout of the AWK-3131A-M12-RCC

Top Panel

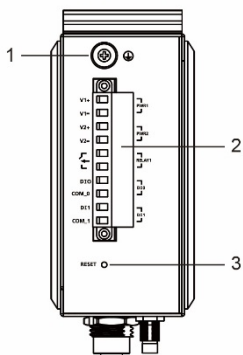

1. Grounding screw (M5)
2. Terminal block for PWR1, PWR2, relay, DI0, and DI1
3. Reset button
4. A antenna connector
5. B antenna connector
6. System LEDs: PWR1, PWR2, PoE, FAULT, and STATE
7. Signal strength indicator
8. CLIENT, WLAN, and LAN LEDs
9. RS-232 console port
10. M12 LAN Port: 10/100/1000BaseT(X)
11. Model name
12. Screw holes for wall mounting kit
13. DIN-rail mounting kit

Front Panel

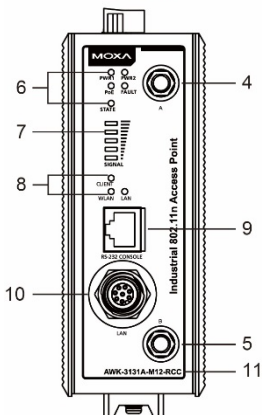

Back Panel

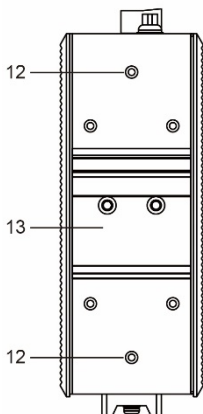

Mounting Dimensions (unit = mm)

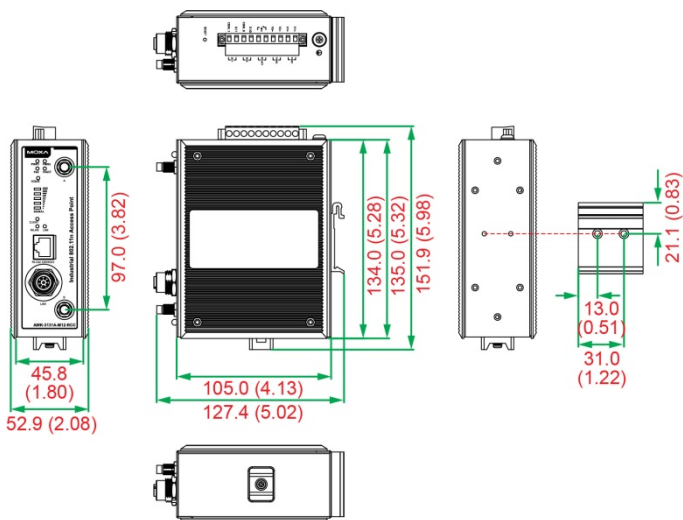

DIN-rail Mounting

The aluminum DIN-rail attachment plate should be fixed to the back panel of the AWK-3131A-M12-RCC when you take it out of the box. If you need to reattach the DIN-rail attachment plate to the AWK-3131A-M12-RCC, make sure the stiff metal spring is situated towards the top, as shown in the figures below.

STEP 1:

Insert the top of the DIN rail into the slot just below the stiff metal spring.

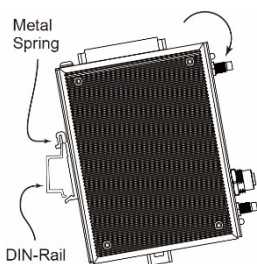

STEP 2:

The DIN-rail attachment unit will snap into place as shown below.

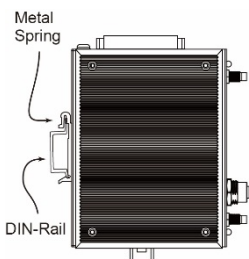

To remove the AWK-3131A-M12-RCC from the DIN rail, simply reverse Steps 1 and 2.

Wall Mounting (optional)

For transportation applications that require an EN 50155 certification report, we strongly recommend the purchase of the optional AWK-3131A-M12-RCC wall-mounting kit, which has passed EN 50155 testing. This wall-mounting kit is also convenient for other applications that require mounting the AWK-3131A-M12-RCC to a wall.

STEP 1:

Remove the aluminum DIN-rail attachment plate from the AWK-3131A-M12-RCC, and then attach the wall mount plates with M3 screws, as shown in the adjacent diagrams.

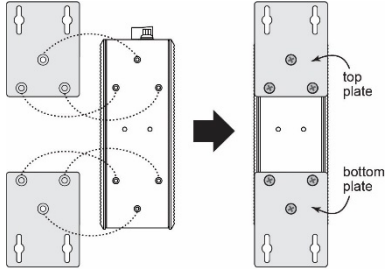

STEP 2:

Mounting the AWK-3131A-M12-RCC to a wall requires 4 screws. Use the AWK-3131A-M12-RCC device, with wall mount plates attached, as a guide to mark the correct locations of the 4 screws. The heads of the screws should be less than 6.0 mm in diameter, and the shafts should be less than 3.5 mm in diameter, as shown in the figure at the right.

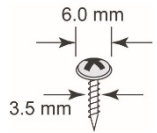

Do not screw the screws in all the way—leave a space of about 2 mm to allow room for sliding the wall mount panel between the wall and the screws.

NOTE Test the screw head and shank size by inserting the screw into one of the keyhole shaped apertures of the Wall Mounting Plates before it is screwed into the wall.

STEP 3:

Once the screws are fixed into the wall, insert the four screw heads through the large opening of the keyhole-shaped apertures, and then slide the AWK-3131A-M12-RCC downwards, as indicated to the right. Tighten the three screws for added stability.

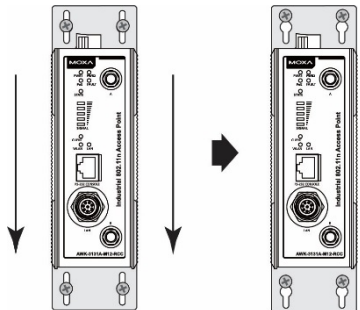



WARNING

- This equipment is intended to be used in a Restricted Access Location, such as a dedicated computer room, a cabinet, or space specially reserved for device installation onboard a train. Access can only be gained by SERVICE PERSONS or by USERS who have been instructed to comply with the safety rules thereby avoiding casualties from electric shock, cutting from a sharp edge, heat from a metallic surface, and so on.
- Service persons or users have to pay special attention and take special precautions before handling equipment.
- Access is to be controlled through the use of a lock and key or a security identity system, controlled by the authority responsible for the location. Only authorized, well-trained professionals are allowed to access the restricted access location.
- The metallic surface of the product may be hot when it is installed in cabinets, places with direct sunlight, or next to a high heat source. Pay special attention or use special protection before handling equipment.

Wiring Requirements



WARNING

Safety First!

Be sure to disconnect the power cord before installing and/or wiring your Moxa AWK-3131A-M12-RCC.



WARNING

Safety First!

Calculate the maximum possible current in each power wire and common wire. Observe all electrical codes dictating the maximum current allowed for each wire size.

If the current goes above the maximum ratings, the wiring could overheat, causing serious damage to your equipment.

You should also pay attention to the following items:

- Use separate paths to route wiring for power and devices. If power wiring and device wiring paths must cross, make sure the wires are perpendicular at the intersection point.
NOTE: Do not run signal or communications wiring and power wiring in the same wire conduit. To avoid interference, wires with different signal characteristics should be routed separately.
- You can use the type of signal transmitted through a wire to determine which wires should be kept separate. The rule of thumb is that wiring with similar electrical characteristics can be bundled together.
- Keep input wiring and output wiring separate.
- It is strongly advised that you label wiring to all devices in the system when necessary.



ATTENTION

This product is intended to be supplied by a Listed Power Unit marked "Class 2" or "LPS" and rated O/P: 12 to 48 VDC, minimum 6 W (12 V to 48V), 25°C.



ATTENTION

Make sure the external power adapter (includes power cords and plug assemblies) provided with the unit is certified and suitable for use in your country.



ATTENTION

Do not use the PoE Injector. Instead, please use an IEEE802.3af or IEEE802.3at compliant PSE (Power Sourcing Equipment) for PoE (Power over Ethernet) device.

Grounding the Moxa AWK-3131A-M12-RCC

Grounding and wire routing help limit the effects of noise due to electromagnetic interference (EMI). Run the ground connection from the ground screw to the grounding surface prior to connecting devices.



ATTENTION

This product is intended to be mounted to a well-grounded mounting surface, such as a metal panel.

Connecting the Power Input

Pinouts for the Power Inputs and Relay Output

Pin	Name	Usage
1	V1+	DC Power Input 1
2	V1-	
3	V2+	DC Power Input 2
4	V2-	
5		Relay Output
6		
7	I1	Digital Input
8	COM_1	Digital Input GND
9	I2	Digital Input
10	COM_2	Digital Input GND

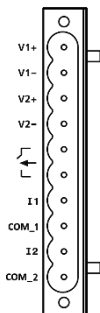

Wiring the Dual Power Inputs

The top two pairs of contacts of the 10-contact terminal block connector on the AWK-3131A-M12-RCC's top panel are used for the AWK-3131A-M12-RCC's two DC inputs. Top and front views of the terminal block connector are shown below.

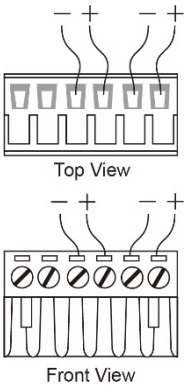

STEP 1:

Insert the negative/positive DC wires into the V-/V+ terminals.

STEP 2:

To keep the DC wires from pulling loose, use a small flat-blade screwdriver to tighten the wire-clamp screws on the front of the terminal block connector.

STEP 3:

Insert the plastic terminal block connector prongs into the terminal block receptor, which is located on the AWK-3131A-M12-RCC's top panel.

NOTE Before connecting the AWK-3131A-M12-RCC to the DC power inputs, make sure the DC power source voltage is stable.

Wiring the Relay Contact

The AWK-3131A-M12-RCC has one relay output, which consists of the two contacts of the terminal block on the AWK-3131A-M12-RCC's top panel. The two wires attached to the Relay contacts form an open circuit when a user-configured event, such as the network connection status change, DI0/1 status change, or power status change, is triggered. If a user-configured event does not occur, the Relay circuit will be closed.

Wiring the Digital Inputs

The AWK-3131A-M12-RCC has two sets of digital input—DI0 and DI1. Each DI comprises two contacts of the 10-pin terminal block connector on the AWK-3131A-M12-RCC's top panel.

Cable Holder Installation

You can attach the cable holder to the bottom of the AWK-3131A-M12-RCC. This helps to keep cabling neat and avoid accidents that result from untidy cables.

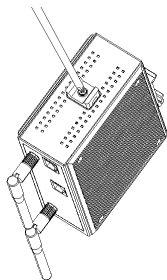

STEP 1:

Screw the cable holder onto the bottom of the AWK-3131A-M12-RCC.

STEP 2: After mounting the AWK-3131A-M12-RCC and plugging in the LAN cable, tighten the cable along the device and wall.

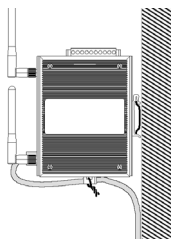
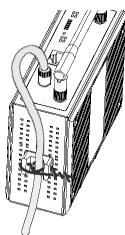
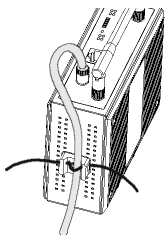

Communication Connections

10/100/1000BaseT(X) Ethernet Port Connection

All AWK-3131A-M12-RCCs have a 10/100/1000BaseT(X) Ethernet port (8-pin shielded M12 connector with A coding). The 10/100/1000TX port located on the AWK-3131A-M12-RCC front panel is used to connect to Ethernet-enabled devices. Most users configure this port for Auto MDI/MDI-X mode, in which case the port's pinouts are adjusted automatically depending on the type of Ethernet cable used (straight-through or cross-over), and the type of device (NIC-type or HUB/Switch-type) connected to the port.

Pinouts for the 10/100/1000BaseT(X) M12 (8-pin) Port

PIN	Con.
1	TRD3+
2	TRD4+
3	TRD4-
4	TRD1-
5	TRD2+
6	TRD1+
7	TRD3-
8	TRD2-

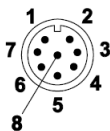

RS-232 Connection

The AWK-3131A-M12-RCC has one RS-232 (8-pin RJ45) console port on the front panel. Use either an RJ45-to-DB9 or RJ45-to-DB25 cable to connect the AWK-3131A-M12-RCC console port to your PC's COM port. You may then use a console terminal program to access the AWK-3131A-M12-RCC for console configuration.

Console Pinouts for 10-pin or 8-pin RJ45

10-Pin	Description	8-Pin
1	-	
2	DSR	1
3	RTS	2
4	GND	3
5	TxD	4
6	RxD	5
7	DCD	6
8	CTS	7
9	DTR	8
10	-	

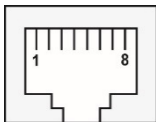

ATTENTION

Although the isolated power module and housing insulation are both built in into the AWK-3131A-M12-RCC, it is recommended that the AWK-3131A-M12-RCC devices are attached to a galvanically isolated power supply or a DC/DC power isolator is used, both being compliant with the EN 50155 standard.

Reset Button

The **RESET** button is located on the top panel of the AWK-3131A-RCC. You can reboot the AWK-3131A-M12-RCC or reset it to factory default settings by pressing the **RESET** button with a pointed object such as an unfolded paper clip.

- **System reboot:** Hold the RESET button down for under 5 seconds and then release.
- **Reset to factory default:** Hold the RESET button down for over 5 seconds until the **STATE** LED starts blinking green. Release the button to reset the AWK-3131A-M12-RCC.

LED Indicators

The front panel of the Moxa AWK-3131A-M12-RCC contains several LED indicators:

LED	Color	State	Description
PWR1	Green	On	Power is being supplied from power input 1.
		Off	Power is not being supplied from power input 1.
PWR2	Green	On	Power is being supplied from power input 2.
		Off	Power is not being supplied from power input 2.

LED	Color	State	Description
PoE	Amber	On	Power is being supplied via PoE.
		Off	Power is not being supplied via PoE.
FAULT	Red	On	System is booting or A system configuration error exists or A relay event has occurred
		Blinking (slowly at 1-sec intervals)	Cannot get an IP address from the DHCP server
		Blinking (fast at 0.5-sec intervals)	IP address conflict
		Off	Error condition does not exist.
STATE	Green/ Red	Green	Software Ready
		Green, blinking at 1-sec intervals	The AWK has been located by AWK Search Utility
		Red	Bootling error condition
SIGNAL (5 LEDs)	Green	On	Signal level (for Client/Slave/ACC Slave mode only)
		Off	
CLIENT	Green	On	WLAN is in Client/Slave mode or ACC Slave mode with connection established.
		Off	AP/Master/Sniffer/ACC Master mode or connection is NOT established in ACC Slave mode .
WLAN	Amber	Amber On	WLAN is in AP/Master mode. WLAN is in Client/Slave/ACC Master/ACC Slave mode with connection established.
		Amber, blinking	Traffic in AP/Client/Master/Slave/ACC mode.
		Off	WLAN is in Sniffer mode. WLAN is in Client/Slave/ACC Master/ACC Slave mode without a connection being established or WLAN is not working properly.
LAN	Green	Green	LAN port's 10/100/1000 Mbps link is active.
		Green, blinking	Data traffic at the LAN port.
		Green Off	LAN port is disconnected.

Specifications

WLAN Interface	
Standards	IEEE 802.11a/b/g/n for Wireless LAN IEEE 802.11i for Wireless Security IEEE 802.3 for 10BaseT IEEE 802.3u for 100BaseTX IEEE 802.3ab for 1000BaseT IEEE 802.3af for Power-over-Ethernet IEEE 802.1Q for VLAN

Spread Spectrum and Modulation (typical)	<ul style="list-style-type: none"> • DSSS with DBPSK, DQPSK, CCK • OFDM with BPSK, QPSK, 16QAM, 64QAM • 802.11b: CCK @ 11/5.5 Mbps, DQPSK @ 2 Mbps, DBPSK @ 11 Mbps • 802.11a/g: 64QAM @ 54/48 Mbps, 16QAM @ 36/24 Mbps, QPSK @ 18/12 Mbps, BPSK @ 9/6 Mbps • 802.11n: 64QAM@300 Mbps to BPSK @ 6.5 Mbps (multiple rates supported)
Operating Channels (central frequency)	US: <ul style="list-style-type: none"> • 2.412 to 2.462 GHz (11 channels) • 5.180 to 5.240 (4 channels) • 5.260 to 5.320 (4 channels)* • 5.500 to 5.700 GHz (8 channels, excluding 5.600 to 5.640 GHz)* • 5.745 to 5.825 GHz (5 channels) EU: <ul style="list-style-type: none"> • 2.412 to 2.472 GHz (13 channels) • 5.180 to 5.240 GHz (4 channels) • 5.260 to 5.320 GHz (4 channels)* • 5.500 to 5.700 GHz (11 channels)* JP: <ul style="list-style-type: none"> • 2.412 to 2.484 GHz (14 channels) • 5.180 to 5.240 GHz (4 channels) • 5.260 to 5.320 GHz (4 channels)* • 5.500 to 5.700 GHz (11 channels)*
<p>*DFS (Dynamic Frequency Selection) channel support: In AP mode, when a radar signal is detected, the device will automatically switch to another channel. However according to regulations, after switching channels, a 60-second availability check period is required before starting the service</p>	
Security	<ul style="list-style-type: none"> • SSID broadcast enable/disable • Firewall for MAC/IP/Protocol/Port-based filtering • 64-bit and 128-bit WEP encryption, WPA / WPA2-Personal and Enterprise (IEEE 802.1X/RADIUS, TKIP and AES)
Transmission Rates	802.11b: 1, 2, 5.5, 11 Mbps 802.11a/g: 6, 9, 12, 18, 24, 36, 48, 54 Mbps 802.11n: 6.5 to 300 Mbps (multiple rates supported)
TX Transmit Power	802.11b: <ul style="list-style-type: none"> • Typ. 26±1.5 dBm @ 1 Mbps • Typ. 26±1.5 dBm @ 2 Mbps • Typ. 26±1.5 dBm @ 5.5 Mbps • Typ. 25±1.5 dBm @ 11 Mbps 802.11g: <ul style="list-style-type: none"> • Typ. 23±1.5 dBm @ 6 to 24 Mbps • Typ. 21±1.5 dBm @ 36 Mbps • Typ. 19±1.5 dBm @ 48 Mbps • Typ. 18±1.5 dBm @ 54 Mbps 802.11n (2.4 GHz): <ul style="list-style-type: none"> • Typ. 23±1.5dBm @ MCS0 20 MHz • Typ. 21±1.5dBm @ MCS1 20 MHz • Typ. 21±1.5dBm @ MCS2 20 MHz • Typ. 21±1.5dBm @ MCS3 20 MHz

- Typ. 20±1.5dBm @ MCS4 20 MHz
- Typ. 19±1.5dBm @ MCS5 20 MHz
- Typ. 18±1.5dBm @ MCS6 20 MHz
- Typ. 18±1.5dBm @ MCS7 20 MHz
- Typ. 23±1.5dBm @ MCS8 20 MHz
- Typ. 21±1.5dBm @ MCS9 20 MHz
- Typ. 21±1.5dBm @ MCS10 20 MHz
- Typ. 21±1.5dBm @ MCS11 20 MHz
- Typ. 20±1.5dBm @ MCS12 20 MHz
- Typ. 19±1.5dBm @ MCS13 20 MHz
- Typ. 18±1.5dBm @ MCS14 20 MHz
- Typ. 18±1.5dBm @ MCS15 20 MHz
- Typ. 23±1.5dBm @ MCS0 40 MHz
- Typ. 20±1.5dBm @ MCS1 40 MHz
- Typ. 20±1.5dBm @ MCS2 40 MHz
- Typ. 20±1.5dBm @ MCS3 40 MHz
- Typ. 19±1.5dBm @ MCS4 40 MHz
- Typ. 19±1.5dBm @ MCS5 40 MHz
- Typ. 18±1.5dBm @ MCS6 40 MHz
- Typ. 17±1.5dBm @ MCS7 40 MHz
- Typ. 23±1.5dBm @ MCS8 40 MHz
- Typ. 20±1.5dBm @ MCS9 40 MHz
- Typ. 20±1.5dBm @ MCS10 40 MHz
- Typ. 20±1.5dBm @ MCS11 40 MHz
- Typ. 20±1.5dBm @ MCS12 40 MHz
- Typ. 19±1.5dBm @ MCS13 40 MHz
- Typ. 18±1.5dBm @ MCS14 40 MHz
- Typ. 17±1.5dBm @ MCS15 40 MHz

802.11a:

- Typ. 23±1.5 dBm @ 6 to 24 Mbps
- Typ. 21±1.5 dBm @ 36 Mbps
- Typ. 20±1.5 dBm @ 48 Mbps
- Typ. 18±.5 dBm @ 54 Mbps

802.11n (5 GHz):

- Typ. 23±1.5dBm @ MCS0 20 MHz
- Typ. 20±1.5dBm @ MCS1 20 MHz
- Typ. 20±1.5dBm @ MCS2 20 MHz
- Typ. 20±1.5dBm @ MCS3 20 MHz
- Typ. 19±1.5dBm @ MCS4 20 MHz
- Typ. 18±1.5dBm @ MCS5 20 MHz
- Typ. 18±1.5dBm @ MCS6 20 MHz
- Typ. 18±1.5dBm @ MCS7 20 MHz
- Typ. 23±1.5dBm @ MCS8 20 MHz
- Typ. 20±1.5dBm @ MCS9 20 MHz
- Typ. 20±1.5dBm @ MCS10 20 MHz
- Typ. 20±1.5dBm @ MCS11 20 MHz
- Typ. 19±1.5dBm @ MCS12 20 MHz
- Typ. 19±1.5dBm @ MCS13 20 MHz
- Typ. 18±1.5dBm @ MCS14 20 MHz
- Typ. 18±1.5dBm @ MCS15 20 MHz
- Typ. 23±1.5dBm @ MCS0 40 MHz
- Typ. 20±1.5dBm @ MCS1 40 MHz
- Typ. 20±1.5dBm @ MCS2 40 MHz
- Typ. 20±1.5dBm @ MCS3 40 MHz
- Typ. 19±1.5dBm @ MCS4 40 MHz
- Typ. 18±1.5dBm @ MCS5 40 MHz

	<ul style="list-style-type: none"> •Typ. 18±1.5dBm @ MCS6 40 MHz •Typ. 18±1.5dBm @ MCS7 40 MHz •Typ. 23±1.5dBm @ MCS8 40 MHz •Typ. 20±1.5dBm @ MCS9 40 MHz •Typ. 20±1.5dBm @ MCS10 40 MHz •Typ. 20±1.5dBm @ MCS11 40 MHz •Typ. 19±1.5dBm @ MCS12 40 MHz •Typ. 19±1.5dBm @ MCS13 40 MHz •Typ. 18±1.5dBm @ MCS14 40 MHz •Typ. 18±1.5dBm @ MCS15 40 MHz
RX Sensitivity	<p>802.11b:</p> <ul style="list-style-type: none"> • -93 dBm @ 1 Mbps • -93 dBm @ 2 Mbps • -93 dBm @ 5.5 Mbps • -88 dBm @ 11 Mbps <p>802.11g:</p> <ul style="list-style-type: none"> • -88 dBm @ 6 Mbps • -86 dBm @ 9 Mbps • -85 dBm @ 12 Mbps • -85 dBm @ 18 Mbps • -85 dBm @ 24 Mbps • -82 dBm @ 36 Mbps • -78 dBm @ 48 Mbps • -74 dBm @ 54 Mbps <p>802.11n (2.4 GHz):</p> <ul style="list-style-type: none"> • -89 dBm @ MCS0 20 MHz • -85 dBm @ MCS1 20 MHz • -85 dBm @ MCS2 20 MHz • -82 dBm @ MCS3 20 MHz • -78 dBm @ MCS4 20 MHz • -74 dBm @ MCS5 20 MHz • -72 dBm @ MCS6 20 MHz • -70 dBm @ MCS7 20 MHz • -95 dBm @ MCS8 20 MHz • -90 dBm @ MCS9 20 MHz • -87 dBm @ MCS10 20 MHz • -83 dBm @ MCS11 20 MHz • -80 dBm @ MCS12 20 MHz • -74 dBm @ MCS13 20 MHz • -71 dBm @ MCS14 20 MHz • -69 dBm @ MCS15 20 MHz • -87 dBm @ MCS0 40 MHz • -83 dBm @ MCS1 40 MHz • -83 dBm @ MCS2 40 MHz • -80 dBm @ MCS3 40 MHz • -76 dBm @ MCS4 40 MHz • -73 dBm @ MCS5 40 MHz • -69 dBm @ MCS6 40 MHz • -67 dBm @ MCS7 40 MHz • -93 dBm @ MCS8 40 MHz • -88 dBm @ MCS9 40 MHz • -85 dBm @ MCS10 40 MHz • -82 dBm @ MCS11 40 MHz • -78 dBm @ MCS12 40 MHz • -73 dBm @ MCS13 40 MHz

	<ul style="list-style-type: none"> • -69 dBm @ MCS14 40 MHz • -67 dBm @ MCS15 40 MHz <p>802.11a:</p> <ul style="list-style-type: none"> • -90 dBm @ 6 Mbps • -88 dBm @ 9 Mbps • -88 dBm @ 12 Mbps • -85 dBm @ 18 Mbps • -81 dBm @ 24 Mbps • -78 dBm @ 36 Mbps • -74 dBm @ 48 Mbps • -74 dBm @ 54 Mbps <p>802.11n (5 GHz):</p> <ul style="list-style-type: none"> • -88 dBm @ MCS0 20 MHz • -85 dBm @ MCS1 20 MHz • -82 dBm @ MCS2 20 MHz • -79 dBm @ MCS3 20 MHz • -76 dBm @ MCS4 20 MHz • -71 dBm @ MCS5 20 MHz • -70 dBm @ MCS6 20 MHz • -69 dBm @ MCS7 20 MHz • -95 dBm @ MCS8 20 MHz • -91 dBm @ MCS9 20 MHz • -87 dBm @ MCS10 20 MHz • -80 dBm @ MCS11 20 MHz • -78 dBm @ MCS12 20 MHz • -74 dBm @ MCS13 20 MHz • -72 dBm @ MCS14 20 MHz • -71 dBm @ MCS15 20 MHz • -84 dBm @ MCS0 40 MHz • -81 dBm @ MCS1 40 MHz • -77 dBm @ MCS2 40 MHz • -75 dBm @ MCS3 40 MHz • -71 dBm @ MCS4 40 MHz • -67 dBm @ MCS5 40 MHz • -64 dBm @ MCS6 40 MHz • -63 dBm @ MCS7 40 MHz • -90 dBm @ MCS8 40 MHz • -85 dBm @ MCS9 40 MHz • -82 dBm @ MCS10 40 MHz • -81 dBm @ MCS11 40 MHz • -77 dBm @ MCS12 40 MHz • -73 dBm @ MCS13 40 MHz • -71 dBm @ MCS14 40 MHz • -68 dBm @ MCS15 40 MHz
--	--

Protocol Support	
-------------------------	--

General Protocols	Proxy ARP, DNS, HTTP, HTTPS, IP, ICMP, SNMP, TCP, UDP, RADIUS, SNMP, PPPoE, DHCP
-------------------	--

Interface	
------------------	--

AP-only Protocols	ARP, BOOTP, DHCP
-------------------	------------------

Interface	
------------------	--

Connector for External Antennas	QMA (female)
---------------------------------	--------------

M12 Ports	1, 10/100/1000BaseT(X) auto negotiation speed, F/H duplex mode, and auto MDI/MDI-X connection
-----------	---

Console Port	RS-232 (RJ45-type)
--------------	--------------------

LED Indicators	PWR1, PWR2, PoE, FAULT, STATE, signal strength, CLIENT MODE, WLAN, LAN
Alarm Contact	1 relay output with current carrying capacity of 1 A @ 24 VDC
Digital Inputs	2 electrically isolated inputs <ul style="list-style-type: none"> • +13 to +30 V for state "1" • +3 to -30 V for state "0" • Max. input current: 8 mA

Physical Characteristics

Housing	Metal, providing IP30 protection
Weight	850 g (1.87 lb)
Dimensions	52.9 x 151.9 x 127.4 mm (2.08 x 5.98 x 5.02 in)
Installation	DIN-rail mounting (standard), wall mounting (optional kit)

Environmental Limits

Operating Temperature	Standard Models: -25 to 60°C (-13 to 140°F) Wide Temp. Models: -40 to 75°C (-40 to 167°F)
Storage Temperature	-40 to 85°C (-40 to 185°F)
Ambient Relative Humidity	5% to 95% (non-condensing)

Power Requirements

Input Voltage	12 to 48 VDC, redundant dual DC power inputs or 48 VDC Power-over-Ethernet (IEEE 802.3af compliant)
Input Current	12 V / 0.67 A @ 12 VDC, to 0.17 A @48 VDC, 25°C
Connector	10-pin removable terminal block
Power Consumption	12 to 48 VDC, 670 mA
Reverse Polarity Protection	Present

Standards and Certifications

Safety	EN 60950-1(LVD), UL 60950-1, IEC 60950-1(CB)
EMC	EN 55032/24
EMI	CISPR 32, FCC Part 15B Class B
EMI	IEC 61000-4-2 ESD: Contact: 8 kV; Air: 15 kV IEC 61000-4-3 RS: 80 MHz to 1 GHz: 20 V/m IEC 61000-4-4 EFT: Power: 2 kV; Signal: 2 kV IEC 61000-4-5 Surge: Power: 2 kV; Signal: 2 kV IEC 61000-4-6 CS: 10 V IEC 61000-4-8
Radio	EU: EN 300 328, EN 301 893 US: FCC ID SLE-WAPN008 JP: TELEC Singapore: IDA*
Rail Traffic	EN 50155**, EN 50121-1/4, EN 45545-2

**Complies with a portion of EN 50155 specifications.

Note: Please check Moxa's website for the most up-to-date certification status.

* Regional notice for Singapore

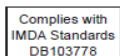

This MOXA product complies with IMDA Standards.

MTBF (mean time between failures)	
Time	742,649 hrs
Standard	Telcordia SR332
Warranty	
Warranty Period	5 years
Details	See www.moxa.com/support/warranty.aspx



ATTENTION

The AWK-3131A-M12-RCC is **NOT** a portable mobile device and should be located at least 20 cm away from the human body. The AWK-3131A-M12-RCC is **NOT** designed for the general public. To deploy AWK-3131A-M12-RCCs and establish a wireless network safely, a well-trained technician is required for installation.



ATTENTION

Use the antennas correctly: The 2.4 GHz antennas are needed when the AWK-3131A-M12-RCC operates in IEEE 802.11b/g/n. The 5 GHz antennas are needed for IEEE 802.11a/n. Make sure your antenna installation is within a safety area, which is covered by a lightning protection or surge arrest system.