

UPort 1200-G2/UPort 1400-G2/ UPort 1600-8-G2 Series User Manual

Version 2.1, May 2025

www.moxa.com/products



© 2025 Moxa Inc. All rights reserved.

UPort 1200-G2/UPort 1400-G2/UPort 1600-8-G2 Series User Manual

The software described in this manual is furnished under a license agreement and may be used only in accordance with the terms of that agreement.

Copyright Notice

© 2025 Moxa Inc. All rights reserved.

Trademarks

The MOXA logo is a registered trademark of Moxa Inc.
All other trademarks or registered marks in this manual belong to their respective manufacturers.

Disclaimer

- Information in this document is subject to change without notice and does not represent a commitment on the part of Moxa.
- Moxa provides this document as is, without warranty of any kind, either expressed or implied, including, but not limited to, its particular purpose. Moxa reserves the right to make improvements and/or changes to this manual, or to the products and/or the programs described in this manual, at any time.
- Information provided in this manual is intended to be accurate and reliable. However, Moxa assumes no responsibility for its use, or for any infringements on the rights of third parties that may result from its use.
- This product might include unintentional technical or typographical errors. Changes are periodically made to the information herein to correct such errors, and these changes are incorporated into new editions of the publication.

Technical Support Contact Information

www.moxa.com/support

Table of Contents

1. Introduction	4
Overview	5
Automatic Data Direction Control (ADDC) for RS-485	5
Automatic Recovery Data Communication (ARDC)	5
Ordering Information	5
Package Checklist.....	5
Optional Accessories (can be purchased separately)	6
Product Features	7
Product Specification.....	7
Panel Layout and Dimensions.....	8
UPort 1200-G2.....	8
UPort 1400-G2.....	9
UPort 1600-8-G2 and -Hub.....	10
2. Product Installation.....	11
Hardware Description and Installation	11
Using an External Power Source.....	11
LED Indicators	11
Connecting to a Serial Device	12
Serial Port Pin Assignments	12
Wiring Adapters Pin Assignments	13
Adjustable Pull High/low Resistors for the RS-485 Port.....	13
Buzzer	14
Latching USB Cable User Guide	15
Ground Screw.....	17
Reset.....	17
Mounting.....	17
Software Driver Installation	25
Installing the Windows Driver	25
Installing the Linux Driver	35
Installing the Mac Driver for macOS.....	36
3. Useful Companion Utilities.....	39
ViewCOM	39
PComm Terminal Emulator.....	40
A. How to Become a Registered User of Moxa Website	44

1. Introduction

In this manual, we refer to the products in this series collectively as the UPort 1200-G2/1400-G2/1600-8-G2 Series, or simply as the UPort.

The UPort comprises USB 3.2-to-serial converters that add two to eight serial ports to a PC through the PC's USB port. The UPort is compatible with both new and legacy RS-232 or RS-422/485 devices. These plug-and-play USB-to-serial converters are ideal for mobile, instrumentation, and point-of sale applications.

The UPort includes the following models:

2-port models

UPort 1250-G2	RS-232/422/485 USB-to-serial converter	0 to 60°C (32 to 140°F)
UPort 1250-G2-T	RS-232/422/485 USB-to-serial converter	-40 to 75°C (-40 to 167°F)
UPort 1250I-G2	RS-232/422/485 USB-to-serial converter with isolation protection	0 to 60°C (32 to 140°F)
UPort 1250I-G2-T	RS-232/422/485 USB-to-serial converter with isolation protection	-40 to 75°C (-40 to 167°F)

4-port models

UPort 1410-G2	RS-232 USB-to-serial converter	0 to 60°C (32 to 140°F)
UPort 1450-G2	RS-232/422/485 USB-to-serial converter	0 to 60°C (32 to 140°F)
UPort 1450-G2-T	RS-232/422/485 USB-to-serial converter	-40 to 75°C (-40 to 167°F)
UPort 1450I-G2	RS-232/422/485 USB-to-serial converter with 2 kV isolation protection	0 to 60°C (32 to 140°F)
UPort 1450I-G2-T	RS-232/422/485 USB-to-serial converter with 2 kV isolation protection	-40 to 75°C (-40 to 167°F)

8-port models

UPort 1610-8-G2	RS-232 USB-to-serial converter	0 to 60°C (32 to 140°F)
UPort 1650-8-G2	RS-232/422/485 USB-to-serial converter	0 to 60°C (32 to 140°F)
UPort 1650-8-G2-T	RS-232/422/485 USB-to-serial converter	-40 to 75°C (-40 to 167°F)
UPort 1650I-8-G2	RS-232/422/485 USB-to-serial converter with 2 kV isolation protection	0 to 60°C (32 to 140°F)
UPort 1650I-8-G2-T	RS-232/422/485 USB-to-serial converter with 2 kV isolation protection	-40 to 75°C (-40 to 167°F)
UPort 1650-8-G2-Hub	RS-232/422/485 USB-to-serial converter with 3 downstream USB type-A slots	0 to 60°C (32 to 140°F)

Overview

The UPort is easy to install and use. After installing the drivers on your PC, connect the UPort to your computer, plug in your serial devices, and you're ready to go. Programming is not required, and you do not need to worry about IRQs, configuring a board, power requirements, or connection schemes.

The UPort complies with USB 3.2, 2.0, and 1.1 specifications, and meets the 5 Gbps of Super-Speed USB 3.2. Connecting serial devices to your computer's USB ports reduces the total cost of ownership, investment in hardware, and long-term management and integration costs.

Most models of the UPort can be powered up by USB bus power and external power, and only the UPort 1650I-8-G2 and UPort 1650-8-G2-Hub converters require external power. You may refer to the **Power Input Supply** section on page 9 for the applicable table.

When an external power adapter or power cord is used, the UPort will only draw 100 mA through the laptop or workstation's USB port.

Automatic Data Direction Control (ADDC) for RS-485

Automatic Data Direction Control (ADDC) simplifies the management of 2-wire RS-485 half-duplex connections, eliminating software interference. Thus, it is unnecessary to write extra code for Windows applications to control the half-duplex protocol. ADDC intelligence is built into the UPort 1200/1400/1600 USB-to-serial converters that support RS-485 serial interfaces.

Automatic Recovery Data Communication (ARDC)

Automatic Recovery Data Communication (ARDC) simplifies the auto recovery of data transmissions even if a cable gets unplugged accidentally. Thus, you do not need to worry about reconfiguring complex settings to ensure smooth data transmissions. If the USB cable is accidentally unplugged, just plug it back into the same port, and the converter will automatically reconnect with the host and continue transferring data. This feature not only reduces reconfiguration time but also the probability of data loss.

Ordering Information

Package Checklist

The UPort is shipped with the following items:

- 1 UPort 1200-G2/1400-G2/1600-8-G2/1650-8-G2-Hub USB-to-serial converter
- 1 USB cable with a latch and screw
 - CBL-USB3-BA-G-120 for all models except for the UPort 1650-8-G2-Hub, 1.2 m, with hook and screw
 - CBL-USB3-BA-G-028 for the UPort 1650-8-G2-Hub, 28 cm, with hook and screw 100 to 240 VAC
- Power adapter for the UPort 1650I-8-G2 and UPort 1650-8-G2-Hub only
- Quick installation guide (printed)
- Warranty card



NOTE

Please notify your sales representative if any of the above items are missing or damaged.

Optional Accessories (can be purchased separately)

Power adapters

	PWR-12300-WP*-S2 0 to 40°C (32 to 140°F)	PWR-12050-*-S2 0 to 40°C (32 to 140°F)	PWR-12150**-SA-T -40 to 75°C (-40 to 167°F)
UPort 1410-G2		✓	
UPort 1450-G2		✓	
UPort 1450-G2-T			✓
UPort 1450I-G2		✓	
UPort 1450I-G2-T			✓
UPort 1610-8-G2		✓	
UPort 1650-8-G2		✓	
UPort 1650-8-G2-T			✓
UPort 1650I-8-G2		✓	
UPort 1650I-8-G2-T			✓
UPort 1650-8-G2-Hub	✓		

* EU/USJP/CN/UK/AU/KR

** EU/USJP/CN/UK/AU



NOTE

This product is intended to be supplied by an approved external power source (UL listed/IEC 60950-1/IEC 62368-1) which output complies with ES1/SELV, PS2/LPS, output rating 12 to 48 VDC, 2.25 A minimum (by DC jack) or 5 VDC, 0.61 A minimum (by USB port), ambient temperature 75°C minimum. If further information or help is needed, please contact your Moxa representative. If a Class I power source is used, the power cord should be connected to a socket outlet with an earthing connection.

Cable:

- **CBL-USB3-BA-G-120:** USB 3.2 Gen 1 cable with latch 1.2 M
- **CBL-USB3-BA-G-028:** USB 3.2 Gen 1 cable with latch 0.28 M
- **CBL-USB3-BA-B-120:** Standard USB 3.2 Gen 1 cable 1.2 M

DIN-rail Kits:

- **DK-UP1200** (for UPort 1200-G2 models)
- **DK-UP1400-G2** (for UPort 1400-G2 models)
- **DK-UP1600-G2** (for UPort 1600-G2 models)

Wall-mounting Kits:

- **WK-35A:** Wall mounting for 2-port models
- **WK-UP400A-BOT-BK:** Wall mounting for 4/8-port models

Rack-mounting Kits:

- **RK-UP1600-G2:** 1U tray rack-mounting kit

Serial Adapters:

- **LB-DB9F-G-01:** Serial loopback adapter
- **ADP-RJ458P-DB9F:** DB9F-to-RJ45 adapter
- **Mini DB9F-to-TB:** DB9F-to-TB adapter

Product Features

The UPort has the following features:

- SuperSpeed USB 3.2 supported (up to 5 Gbps)
- Double-sided LEDs at the corners show power, TX, and RX statuses in both directions
- Cascades with 3 UPort-G2 devices to a port capacity of up to 32 ports; no additional power adapters required (UPort 1650-8-G2-Hub)
- Latching USB cable design for firmer connections
- Additional I/O or IRQ is not required
- Serial transmission speed up to 921.6 Kbps
- 512-byte FIFO and on-chip H/W, S/W flow control
- COM port assignments maintained across different PCs
- Drivers for Windows, Linux, and macOS
- Bus-powered capabilities for most models
- Suitable for 4-wire RS-422/485 and 2-wire RS-485 applications (with additional an adapter)
- Easy maintenance with dual-sided LED indication
- IP20, rugged metal case
- Wide operating temperature models available for -40 to 75°C (-40 to 167°F) environments
- Serial port with 2 kV isolation protection (for "-I" models)
- Optional loopback adapter for easy communication checking
- Wall-mount, DIN-rail, and rackmount accessories available

Product Specification



NOTE

The latest specifications for Moxa's products can be found at <https://www.moxa.com>

Panel Layout and Dimensions

UPort 1200-G2

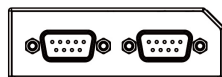
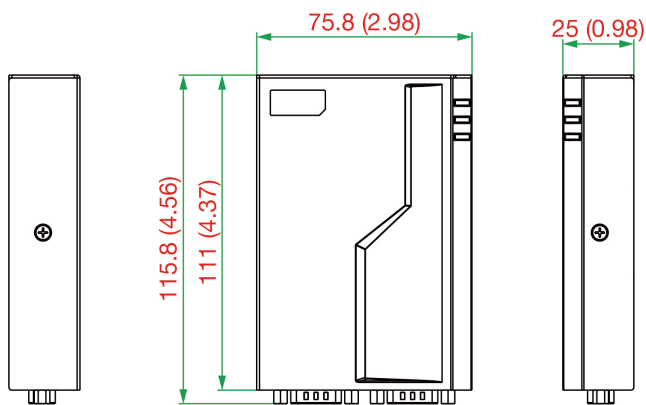
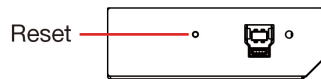

UPort 1400-G2

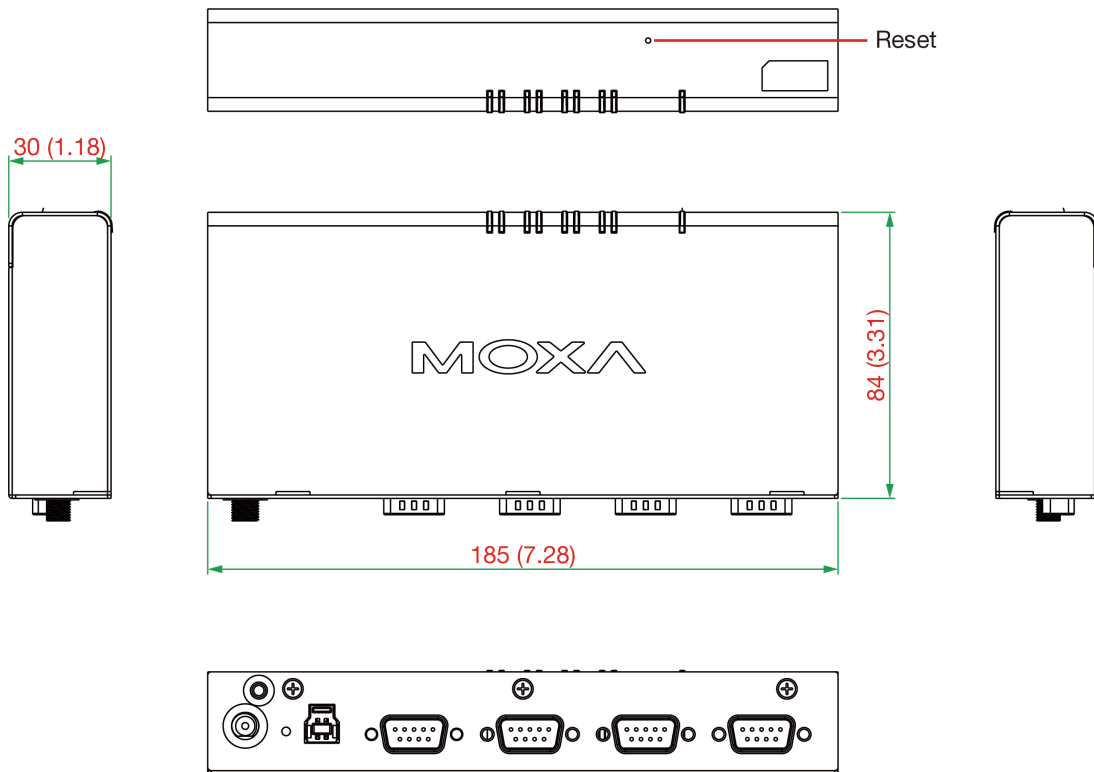

UPort 1600-8-G2 and -Hub

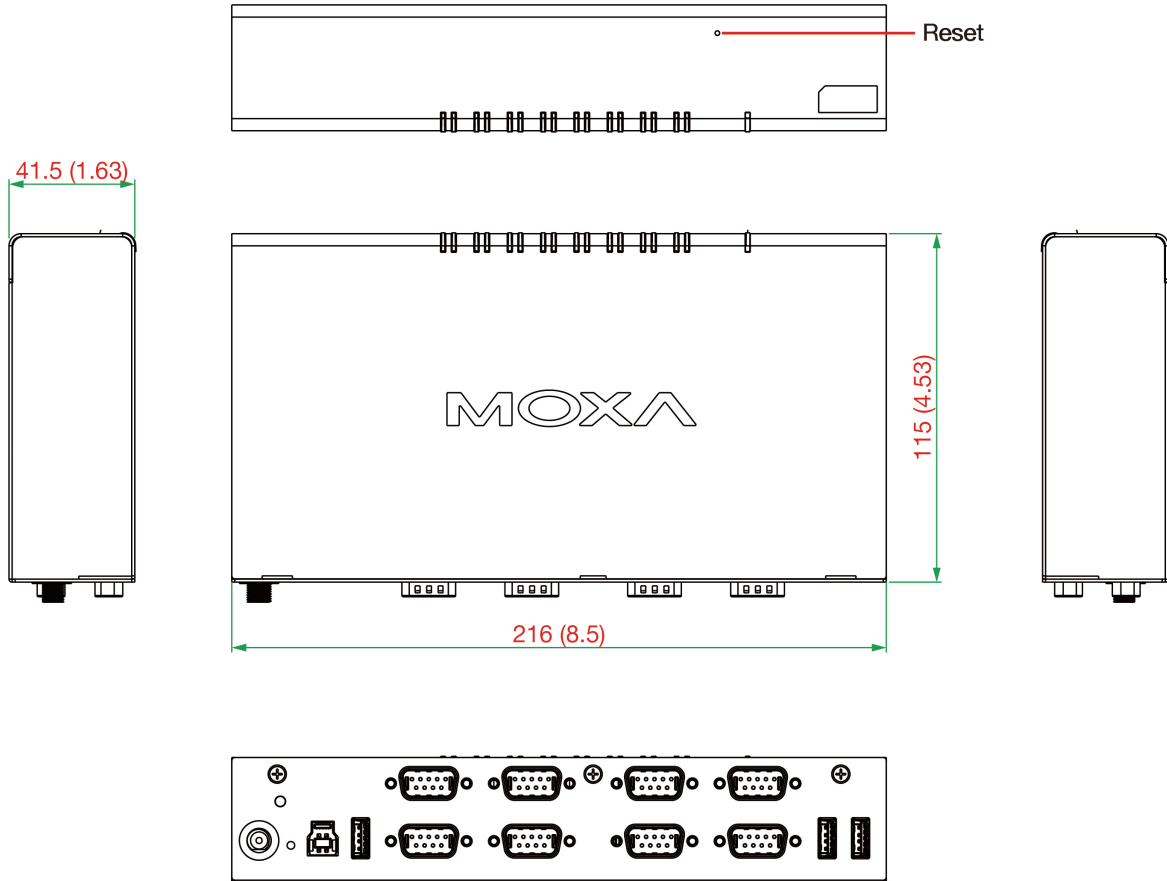

2. Product Installation

We recommend installing the UPort driver first before connecting the UPort to your computer's USB port.

Hardware Description and Installation



NOTE

1. A maximum of 4 UPort converters can be connected to one PC host. Connecting more than 4 UPort converters may strain system resources and potentially destabilize the computer.
2. We recommend connecting the UPort directly to your PC's USB port.
3. Although your UPort supports USB 1.1, we recommend using a USB 3.2 host controller or hub for the best and most stable performance.

Installing the driver before connecting the UPort to your PC. Some UPort models require an external power adapter or cord; other models may support both external and bus power.

	USB 2.0 bus power	USB 3.2 bus power	Power adapter 12 to 48 V
UPort 1250-G2	✓	✓	N/A
UPort 1250I-G2	✓	✓	N/A
UPort 1410-G2	✓	✓	✓
UPort 1450-G2	✓	✓	✓
UPort 1450I-G2	✓	✓	✓
UPort 1610-8-G2	✓	✓	✓
UPort 1650-8-G2	✓	✓	✓
UPort 1650I-8-G2		✓	✓
UPort 1650-8-G2-Hub			✓

Using an External Power Source

The UPort 1650I-8-G2 and UPort 1650-8-G2-Hub come with a power adapter for connecting to an external AC power source. Others can purchase a power adapter separately if necessary.

If the power is properly supplied and the system ready, the Ready LED will glow solid green. For other LED color definitions, please refer to the section below.

LED Indicators

UPort 1200-G2

Function	Color	Definition
Ready	Red	Power is on and the system is not yet ready
	Green	The system is up and ready
	Green blinks	Location in action
	Off	The unit is not powered or out of operation
P1/P2	Green blinks	Transmitting data
	Orange blinks	Receiving data
	Off	No data has been received, or the serial device is not connected or out of operation

UPort 1400-G2 & UPort 1600-8-G2

Function	Color	Definition
Ready	Red	Power is on and the system is not yet ready
	Green	The system is up and ready
	Green blinks	Location in action
	Off	The unit is not powered or out of operation
TX	Green blinks	Transmitting data
	Off	No data is transmitting, or the serial device is not connected or out of operation
RX	Orange blinks	Receiving data
	Off	No data has been received, or the serial device is not connected or out of operation

Connecting to a Serial Device

Use the proper serial cables to connect your serial devices to the UPort's serial ports, which support RS232 and/or RS-422/485 interfaces. The UPort's serial ports use DB9 male connector with standard pin assignment. Please refer below for the detailed pin assignments.

Serial Port Pin Assignments

The serial ports on the UPort have DB9 male connectors. Refer to the following table below for the RS-232 and RS-422/485 pin assignments.

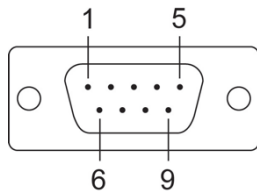

Serial Port (DB9 Male)

Pin	RS-232	RS-422/ RS-485-4W	RS-485-2W
1	DCD	TxD-(A)	-
2	RXD	TxD+(B)	-
3	TXD	RxD+(B)	Data+(B)
4	DTR	RxD-(A)	Data-(A)
5	GND	GND	GND
6	DSR	-	-
7	RTS	-	-
8	CTS	-	-
9	-	-	-



NOTE

For the UPort with DB9 Male serial ports, you may refer to the DB9 Male Ports pin assignment section to loop back pin 2 and pin 3 for the RS-232 interface to carry out a self-test on the device. You may refer to **Communication Testing** in the **Software Installation** section below for how to use the loopback connector in the box to perform the communication test.

Wiring Adapters Pin Assignments



Mini DB9F-to-TB

DB9	TB
1	2
2	1
3	3
4	4
5	5



ADP-RJ45P-DB9F

DB9	RJ45
1	6
2	4
3	5
4	1
5	3
6	8
7	7
8	2

Adjustable Pull High/low Resistors for the RS-485 Port

The UPort uses DIP switches to set the pull high/low resistor values for each serial port.

To set the pull high/low resistors to 150 K Ω , make sure both SW 1 and SW 2 switches are in the **OFF** position. This is the **default setting**.

To set the pull high/low resistors to 1 K Ω , make sure both SW 1 and SW 2 switches are in the **ON** position.

To set the termination on, SW 3 should be set to the **ON** position.

You will need to unscrew the DIP switch cover to access the DIP switches.

Switch	1	2	3	4
	Pull High	Pull Low	Termination	-
ON	1K Ω	1K Ω	120 Ω	-
OFF	150K Ω	150K Ω	-	-

UPort 1200-G2 DIP Switches Location

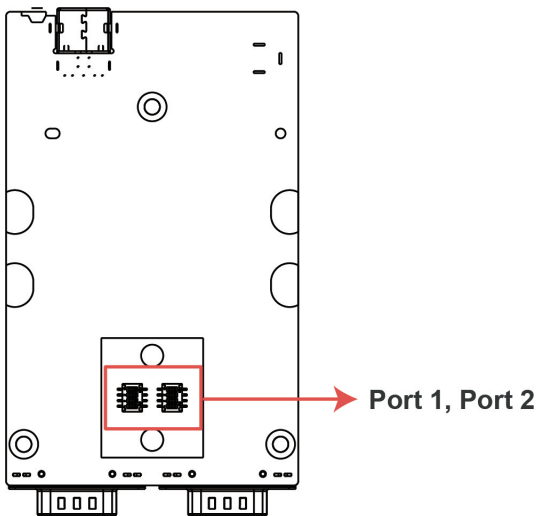

UPort 1400-G2 DIP Switches Location

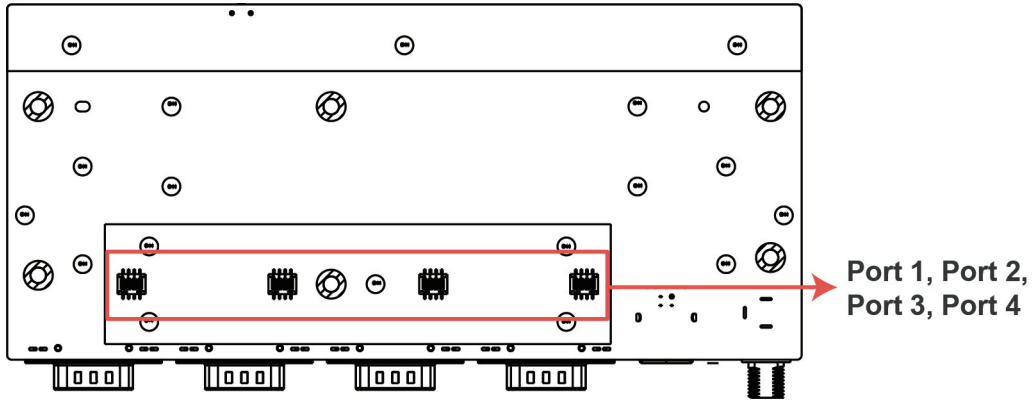

UPort 1600-8-G2 DIP Switches Location

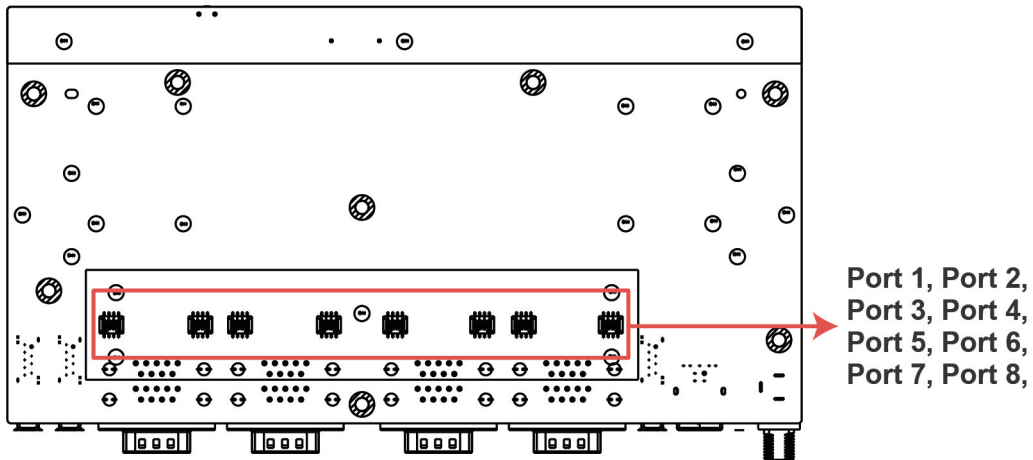

Buzzer

The UPort will sound the built-in buzzer twice when the power is turned on. You will also hear the buzzer when using the **Locate** function from the driver property page of the UPort.

Latching USB Cable User Guide

Here is how you can plug in Moxa's USB cable into the UPort and computer securely.

The new latch USB cable comes with a latch on the side of a type A connector and a screw on the type B:

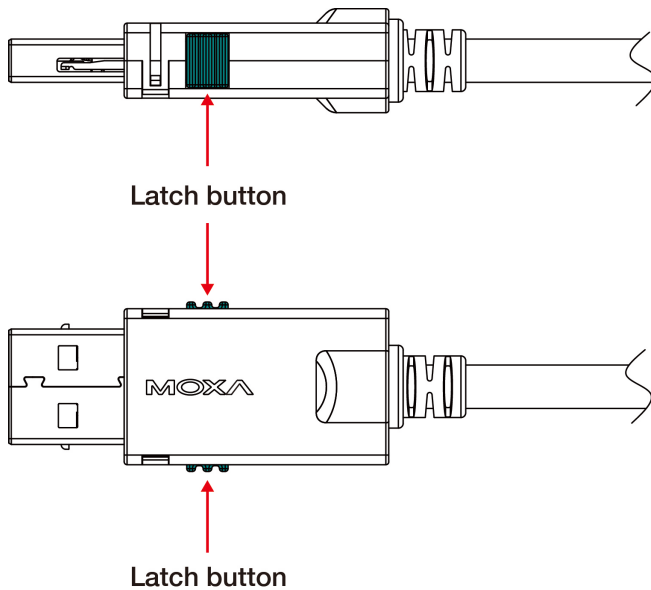

Always press both latches when plugging the connector into the receptacle on your computer.

Plugging in the USB cable to a host computer

Step 1: Press both latches.

Step 2: Plug in.

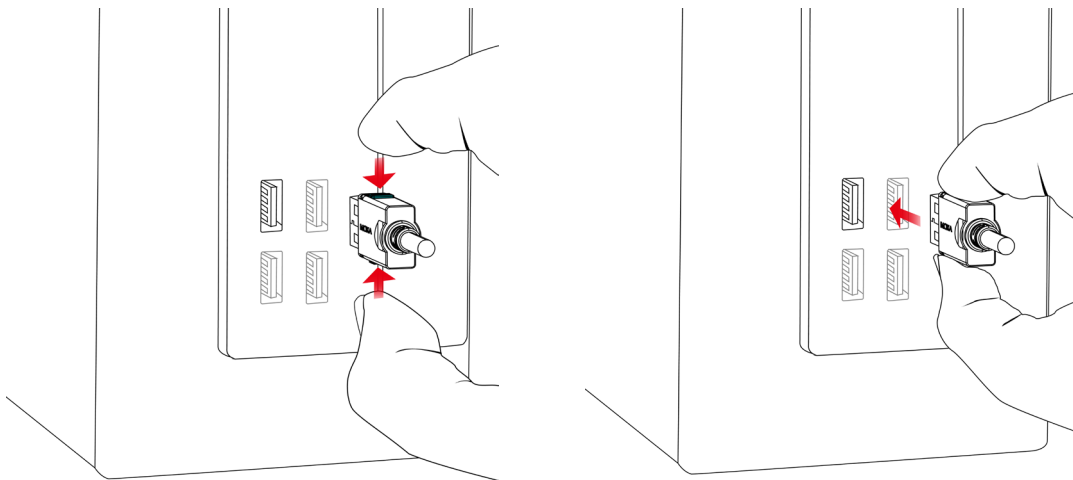

Plugging out a USB cable from a host computer

Step 1: Press both latches hard and make sure they are pushed to the end.

Step 2: Plug out the cable 90 degrees horizontally to the USB slot.

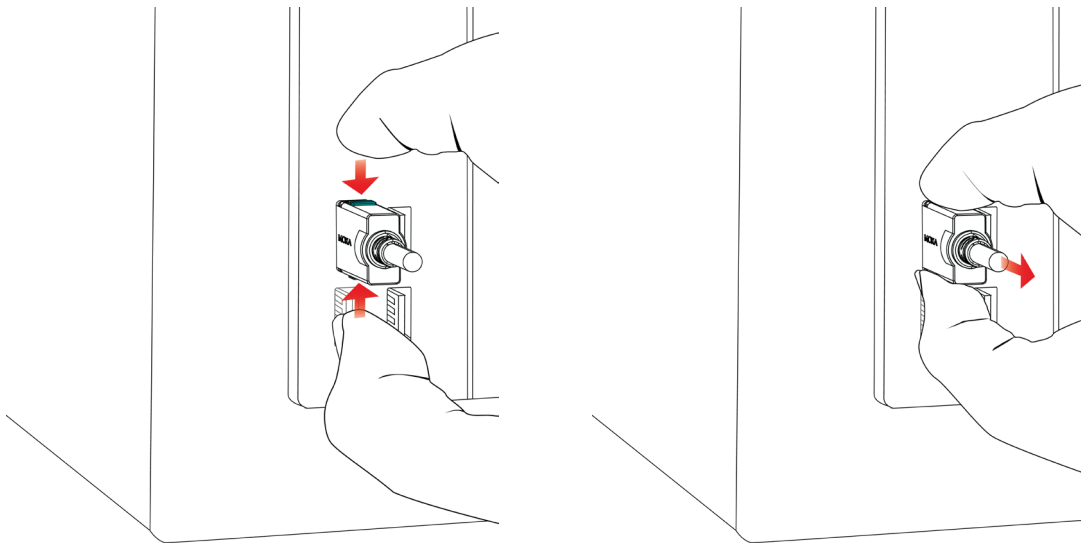

Caution on plugging in or out the latch connector

1. Always press both latches when plugging in or pulling out the cable.
2. If the type A connector doesn't come off smoothly, **DO NOT** pull the cable out by force as it will deform the hook on the connector, and you may not be able to use the cable again. Try again by pushing the latch hard and shaking the connector from left to right gently.



NOTE

The latch cable locks to most computer USB slots, however, there may be some slots designed with a slight difference, preventing the latch from locking to your computer USB slots perfectly.

Plugging in an USB cable to the host computer

The screw on the side of type B connector is for fixing the cable firmly to the UPort. Please remember to swivel bolt after plugging in and before pulling out the connector.

Step 1: Plug in type B connector.

Step 2: Swivel the bolt about 5 rounds.

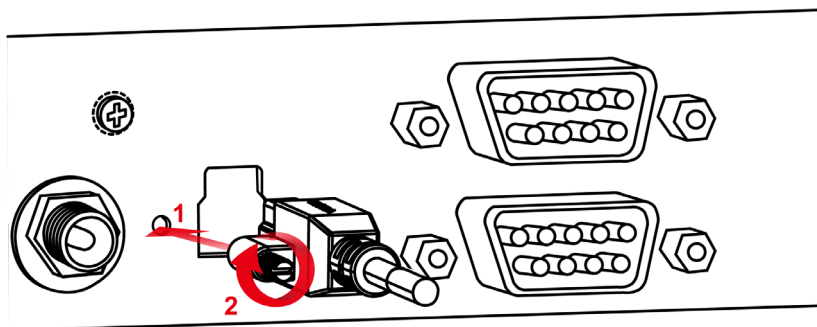

Pulling out an USB cable from the host computer

Step 1: Swivel the bolt about 5 rounds until it is loose.

Step 2: Pulling out the type B connector.

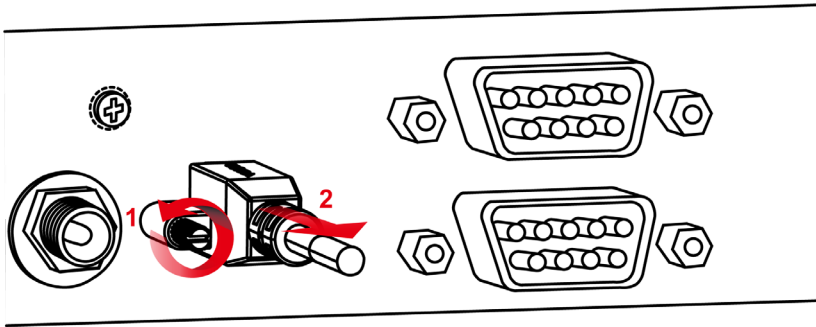

Ground Screw

All the product's certifications are performed with ground-screw wiring. We strongly recommended to wire the ground screw before any operation takes place. With without wiring to a ground screw, please consider the product's environment and prevent any possible surge that may damage the product or cause interference to the communication.

Reset

The reset button is on the front panel of the UPort, and the button is to restart the UPort when necessary. If it is required to reset the UPort to default settings, you will need to access the function in the driver property. Please refer to **Reset to Default** in the **Configuring UPort** section below.

Mounting

UPort 1200-G2

Dimensions

Unit = mm (inches)

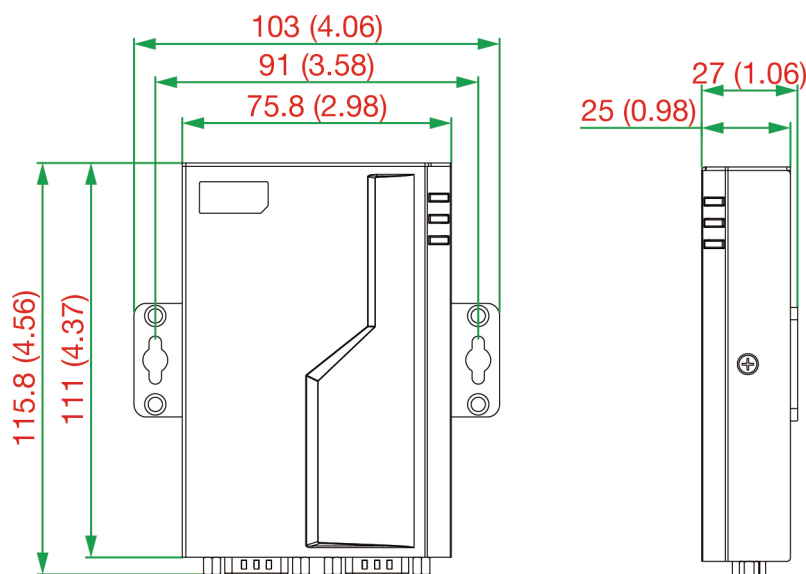

Wall Mounting

The mounting kit is 2 mm in height, and the two centers of the mounting kit on each plate are 91 mm (3.58 in).

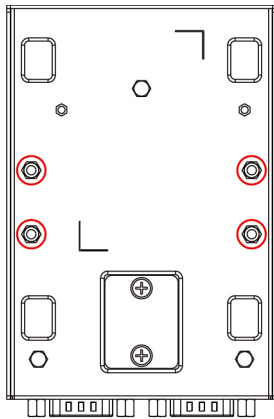

First, attach the brackets to the bottom of the UPort 1200-G2 with screws, where the circles show. The recommended screw tightening torque: 4.5 kgf-cm +/- 0.5, screw type: type F, PH2. Next, mount the unit to a wall with the screws.

Screws should be less than 3.5 mm in head diameter and less than 3.0 mm in shaft diameter.

Screw information:

Type	M3
Quantity	4
Length	4 mm
Head diameter	Less than 5.0 mm
Shaft diameter	Less than 3.0 mm

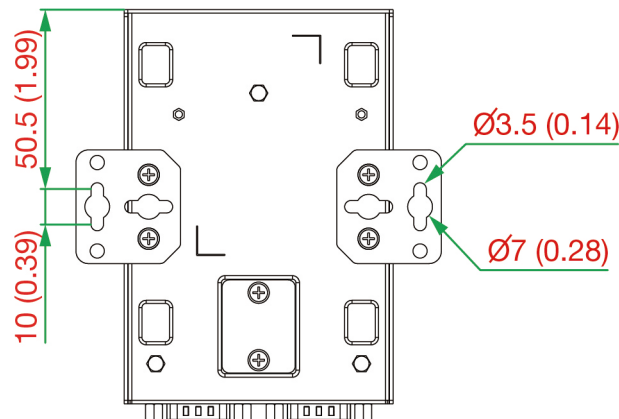
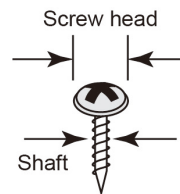

DIN-rail Mounting

The UPort 1200-G2 models have a DIN-rail kit option, - DK35A, allowing installation on a DIN rail. DIN-rail attachments can be purchased separately to attach the product to a DIN rail.

First, attach the wall-mount brackets to the bottom of the UPort 1200-G2 with screws. Then, attach the DIN-rail attachments to the wall-mount kit with screws, as shown by the circles in the figure below. The recommended screw type is M3, 4 mm in length, tightening torque: 4.5 kgf-cm +/- 0.5, screw type: type F, PH2; 4 screws.

Screws should be less than 5 mm in head diameter and less than 3.0 mm in shaft diameter.

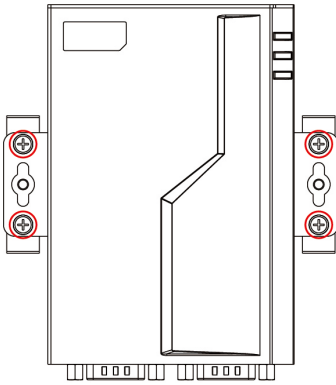

Next, mount the UPort 1200-G2 onto the mounting rail.

STEP 1: Insert the upper lip of the DIN-rail kit into the mounting rail.

STEP 2: Press the UPort 1200-G2 towards the mounting rail until it snaps into place.

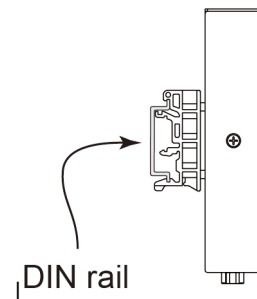
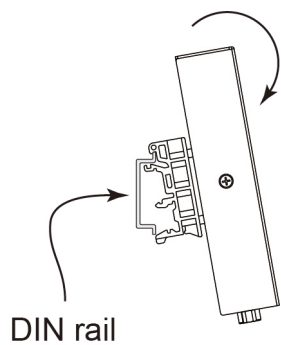

To remove the UPort 1200-G2 from the DIN rail, do the following:

STEP 1:

Pull down the latch on the DIN-rail kit.

STEP 2 & 3:

Slightly pull the UPort 1200-G2 forward and lift it up to remove it from the mounting rail.

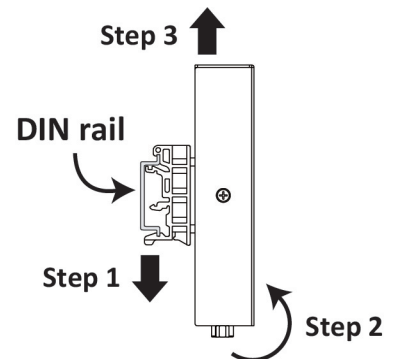

Screw information:

Type	M3
Quantity	4
Length	4 mm
Head diameter	Less than 5.0 mm
Shaft diameter	Less than 3.0 mm

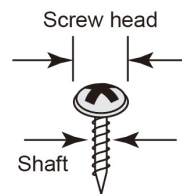

UPort 1400-G2

Dimensions

Unit = mm (inches)

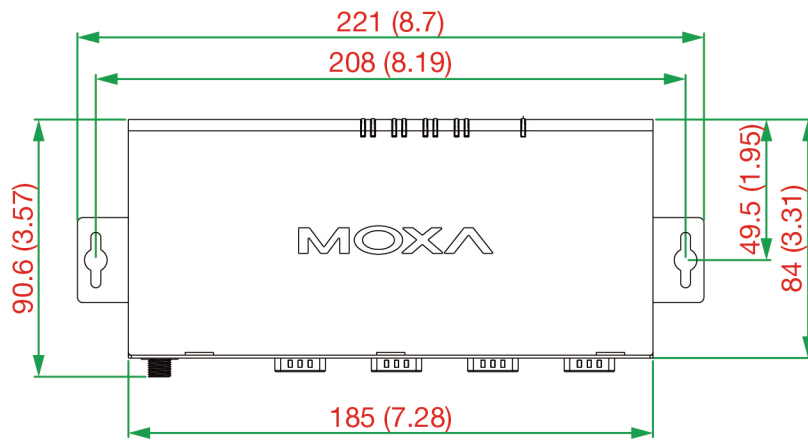

Wall Mounting

The mounting kit is 2 mm in height, and the two centers of the mounting kit on each plate are 208 mm (8.19 in).

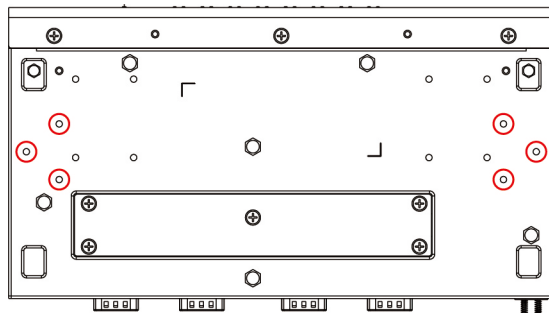
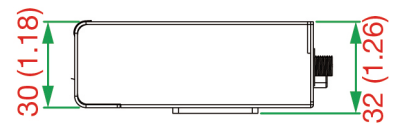

First, attach the brackets to the bottom of the UPort™ 1400-G2 with screws, where the circles show. The recommended screw tightening torque: 4.5 kgf-cm +/- 0.5, screw type: type F, PH2. Next, mount the unit to a wall with the screws.

Screws should be less than 3.5 mm in head diameter, and less than 3.0 mm in shaft diameter.

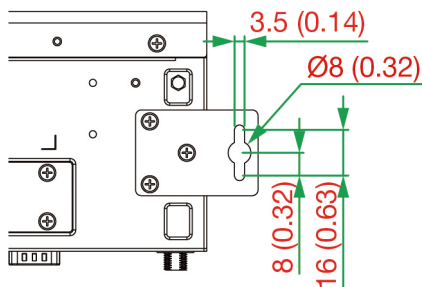
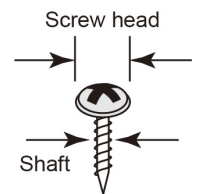

The wall screws should use the M3 type, and the length should be no less than 7 mm.

DIN-rail Mounting

The UPort 1400-G2 models have a DIN-rail kit option to allow installation on a DIN rail. DIN-rail attachments can be purchased separately to attach the product to a DIN rail. The DIN-rail attachments should be oriented with the metal springs on top.

First, attach the DIN-rail attachments to the rear of the UPort™ 1400-G2 with screws, showed by the circles. The recommended screw tightening torque: 4.5 kgf-cm +/- 0.5, screw type: type F, PH2.

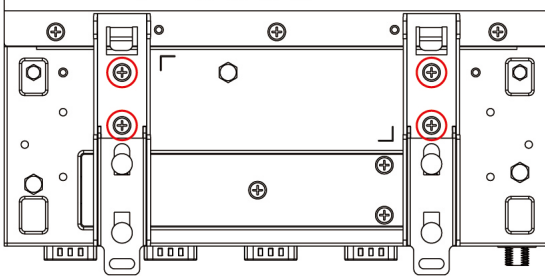

Next, mount the UPort™ 1400-G2 onto the mounting rail.

STEP 1: Insert the upper lip of the DIN-rail kit into the mounting rail.

STEP 2: Press the UPort™ 1400-G2 towards the mounting rail until it snaps into place.

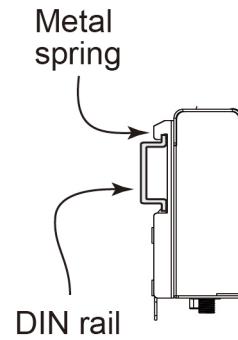
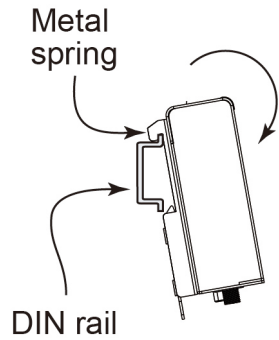

To remove the UPort™ 1400-G2 from the DIN rail, do the following:

STEP 1:

Pull down the latch on the DIN-rail kit with a screwdriver.

STEP 2 & 3:

Slightly pull the UPort™ 1400-G2 forward and lift it up to remove it from the mounting rail.

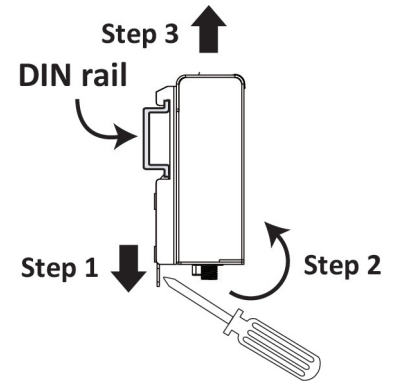

UPort 1600-G2

Dimensions

Unit: mm (inches)

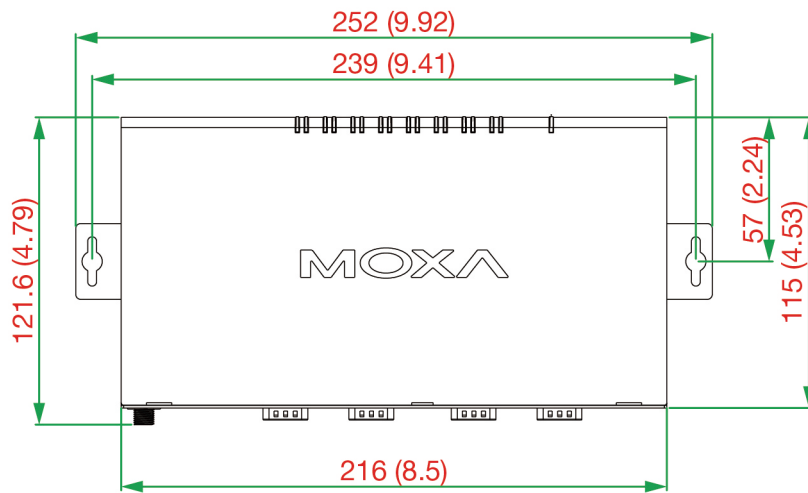

Wall Mounting

The mounting kit is 2 mm in height, and the two centers of the mounting kit on each plate are 239 mm (9.41 in).

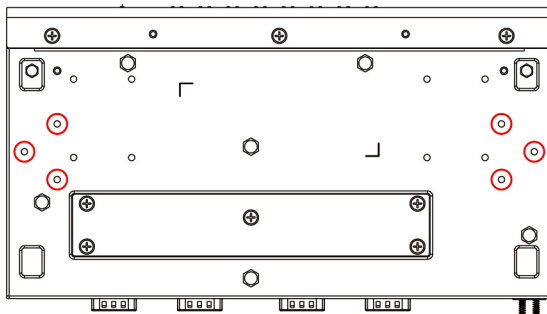
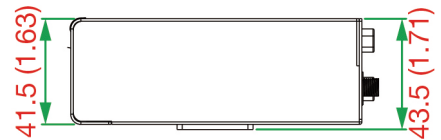

First, attach the brackets to the bottom of the UPort™ 1600-G2 with screws, where the circles show. The recommended screw tightening torque: 4.5 kgf-cm +/- 0.5, screw type: type F, PH2. Next, mount the unit to a wall with the screws.

Screws should be less than 3.5 mm in head diameter, and less than 3.0 mm in shaft diameter.

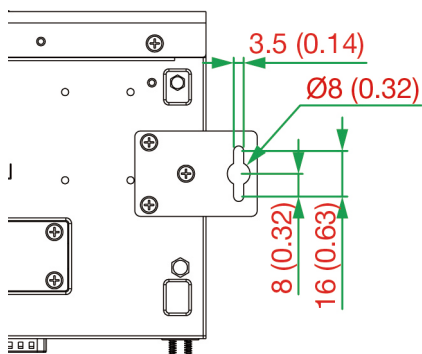
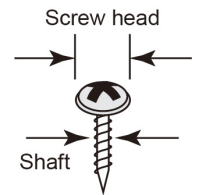

The wall screws should use the M3 type, and the length should be no less than 7 mm.

DIN-rail Mounting

The UPort 1600-G2 models have a DIN-rail kit option to allow installation on a DIN rail. DIN-rail attachments can be purchased separately to attach the product to a DIN rail. The DIN rail attachments should be oriented with the metal springs on top.

First, attach the DIN-rail attachments to the rear of the UPort™ 1600-G2 with screws, showed by the circles. The recommended screw tightening torque: 4.5 kgf-cm +/- 0.5, screw type: type F, PH2.

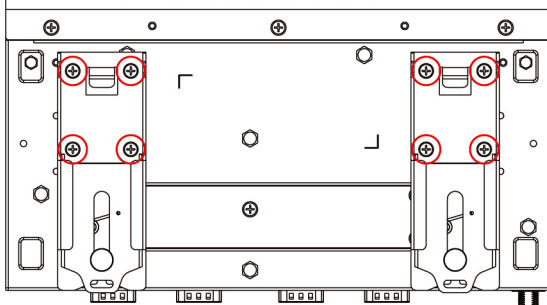

Next, mount the UPort™ 1600-G2 onto the mounting rail.

STEP 1: Insert the upper lip of the DIN-rail kit into the mounting rail.

STEP 2: Press the UPort™ 1600-G2 towards the mounting rail until it snaps into place.

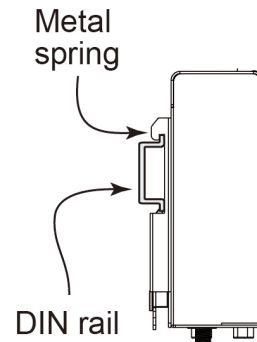
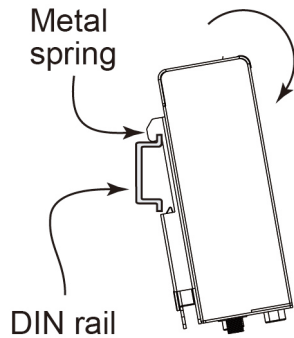

To remove the UPort™ 1600-G2 from the DIN rail, do the following:

STEP 1:

Pull down the latch on the DIN-rail kit with a screwdriver.

STEP 2 & 3:

Slightly pull the UPort™ 1600-G2 forward and lift it up to remove it from the mounting rail.

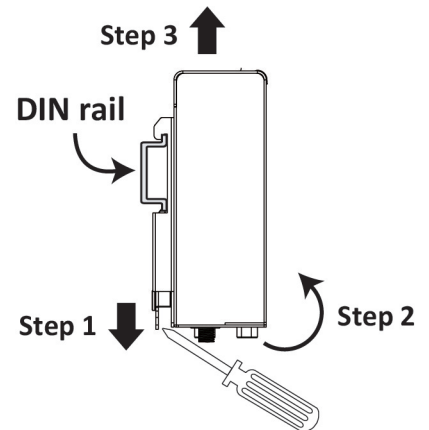

Rackmount mounting

UPort 1400/1600-G2 can be mounted on rackmount along with RK-UP16G2 which is designed with a standard 19-inch rackmount, which can carry maximum 2 of either 4 or 8 port UPort G2 models.

Before you install the UPort to the rackmount kit, please remove the DIN-rail, wall-mount kit or rubber pad from the front panel of the UPort. The button is to restart the UPort when necessary. If resetting the UPort to default settings is required, you will need to access the function in the driver property. Please refer to Reset to Default in the Configuring UPort below.

UPort 1400-G2 screw holes

 Screw holes for the UPort 1400-G2 models

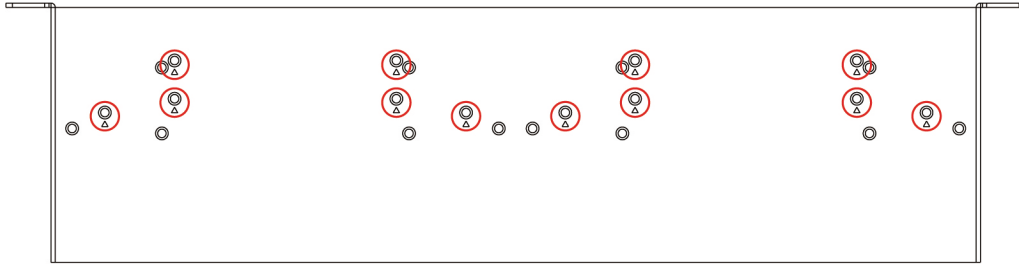

UPort 1600-8-G2 screw holes

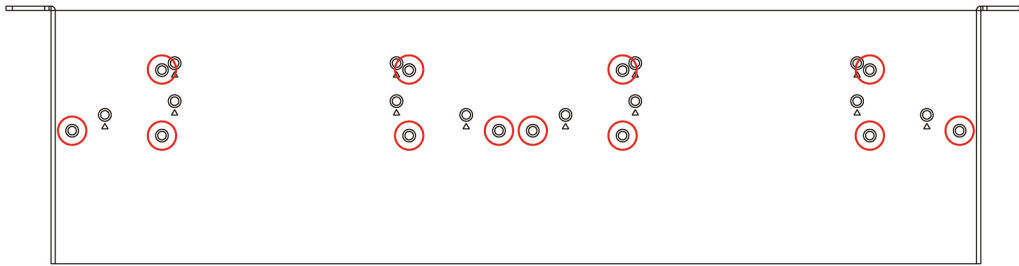

First, attach the UPort at the bottom of the RK-UP16G2 with the screws that come with the product box for the wall-mount kit.

Tightening torque: 4.5 kgf-cm +/- 0.5



NOTE

If you require more screws, please contact your reseller or Moxa sales representative.

If the UPort models on the rackmount are connected directly to a computer or have an external power source from a power adapter, it is fine to place an 8-port or 4-port model on either the right-hand or left-hand side. If you would like to leverage the UPort 8-port hub model's USB bus output power to include other UPort models, the UPort 8-port hub model needs to be placed on the right-hand side of the rackmount tray (left-hand side from the rear view). However, please note it is necessary to use a USB 3.2 compatible cable to ensure enough power.

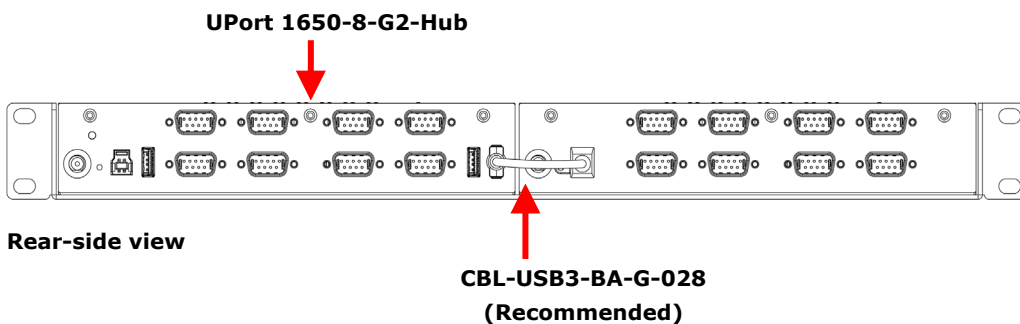

2U Rackmount Illustration

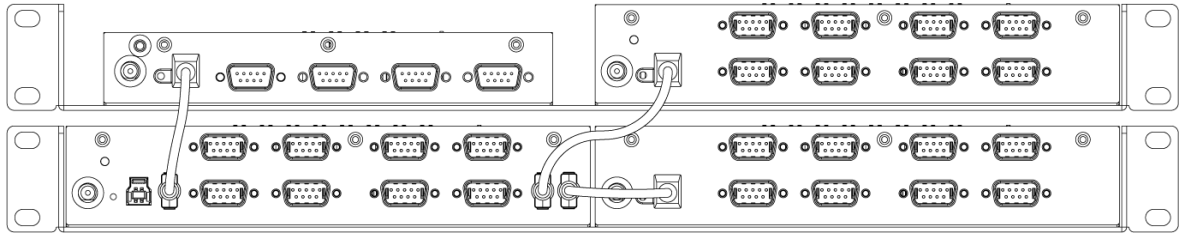

Rear-side view



NOTE

The UPort 1650-8-G2-Hub can cascade and power up to three UPort 1400-G2 or UPort 1600-G2 models (UPort 1650-8-G2-Hub excluded), with USB 3.2 cable.

Software Driver Installation

Installing the Windows Driver

In this section, we use Windows 10 GUI to illustrate how to install the UPort 1400-G2/1600-G2 USB-to-serial converters. The procedures for other Windows platforms are the same.

1. Run the Setup program that you may find on Moxa's support website <http://www.moxa.com/support/>. Follow the steps to complete the installation.
2. The UPort installer provides handy utilities that would help with troubleshooting. It also provides a shortcut to COM port mapping checking and COM port configuration.

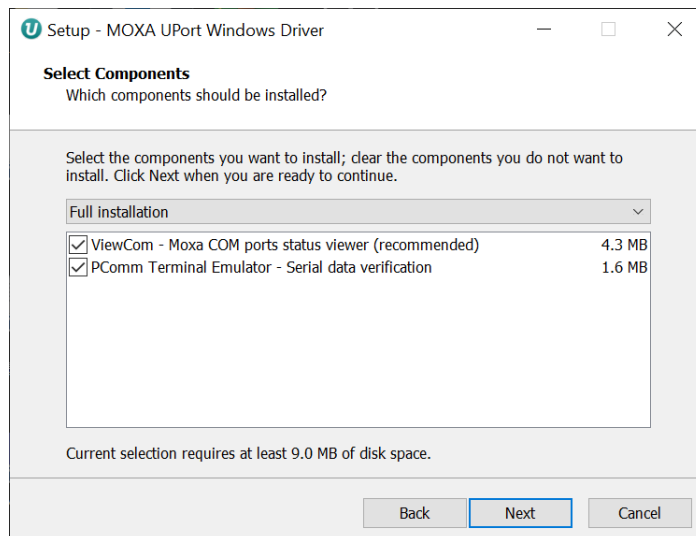

3. The installation will take a few minutes to complete.

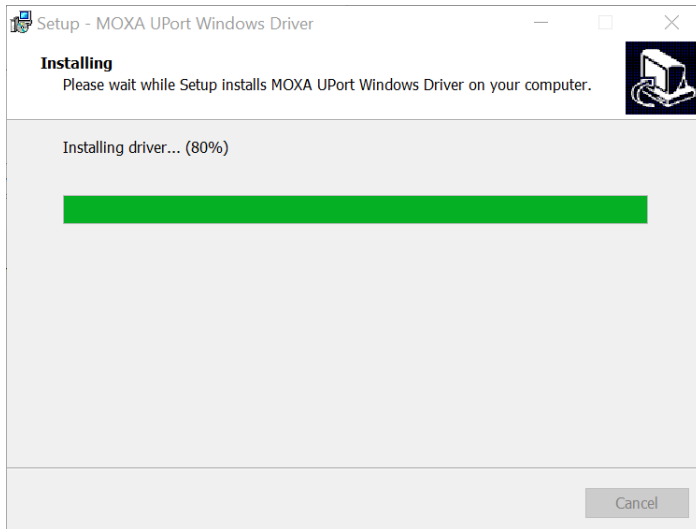

4. After the driver has been installed successfully, connect the UPort to your computer's USB port with the USB cable plugged in.
Windows shall be able to recognize your UPort.

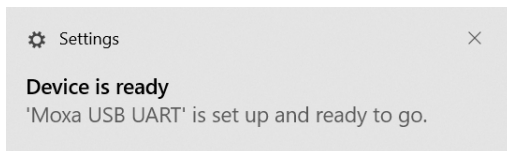

5. Click **Scan** to review the installation results if the UPort is successfully connected to your computer.

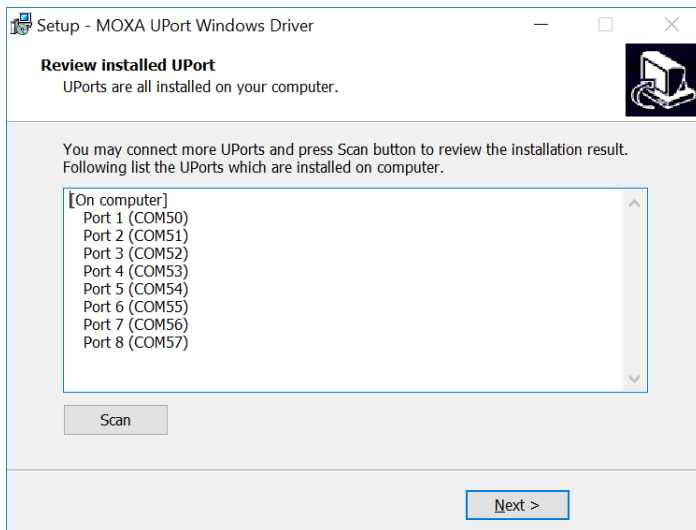

6. Check **Launch Windows Driver Manager** to configure the UPort COM port configuration after quitting the driver installer.

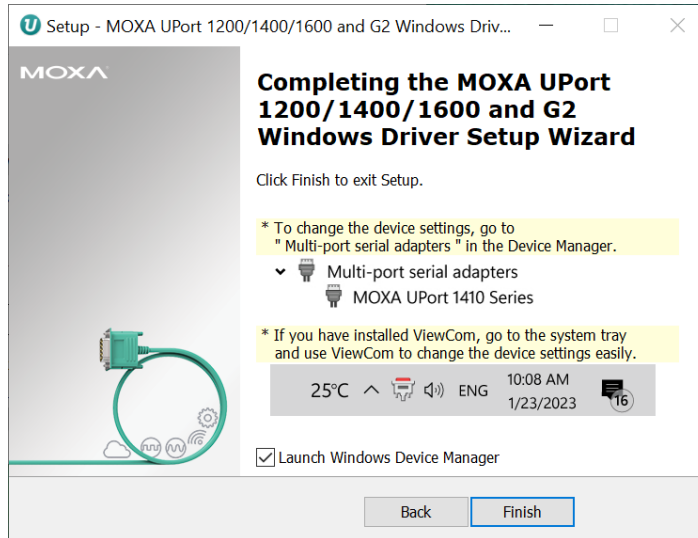

NOTE

1. The operating system will automatically detect the UPort when you plug it into one of your computer's USB ports. If you have installed the latest UPort driver, the UPort and the UPort's serial port will be installed automatically.
2. From time to time, Moxa would roll up a new driver or utility for feature or security enhancements, patches, etc. It may be necessary to visit the UPort product website frequently to check for updates. You may also register for Moxa's website so that you are notified automatically in case of updates. Please refer to **A. How to Become a Register User of the Moxa Website.**

Configuring the UPort

After the driver has been installed, use Windows' **Device Manager** to configure the UPort serial ports.

Expand the **Multi-port serial adapters** tab, double-click mouse button 1 or mouse button 2, click your UPort model, and then click **Properties** to open the UPort's configuration panel.

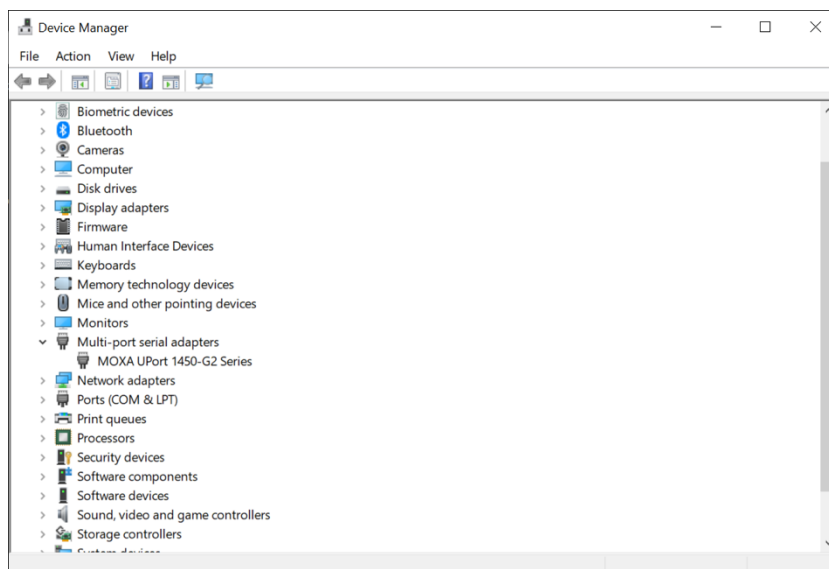

Go to the Device **Settings** page to set up the recognition of your UPort.

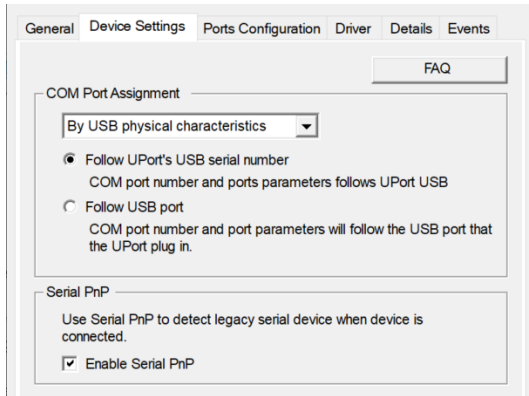

There are two options for **COM Port Assignment**: **By USB physical characteristics** or **By Fixed-base COM mode**.

COM Port Assignment

By USB physical characteristics

- **Follow UPort's USB serial number (the default option)**

Your UPort will be remembered by the built-in USB serial number in the product. The COM no. will be kept and restored when you replug the UPort to your computer.

- **Follow the USB port**

The UPort will be treated as a new device if you plug it into a different USB port on the same computer. A new COM no. may be assigned.

By Fixed-base COM mode

- The initial **COM No.** for the UPort's serial ports will be numbered sequentially, starting with the initial COM port number for all the UPort 1200/1400/1600 and G2 models. This feature is convenient when constantly replacing the product for regular maintenance.

How to enable **Fixed-base COM mode**:

1. In the **COM Port Assignment** drop-down menu, select **By Fixed-base COM mode**.

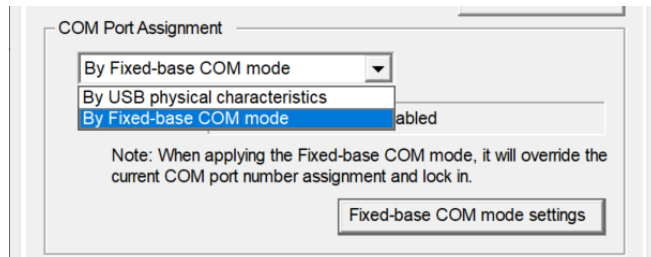

2. Once Fixed-base COM mode is selected, you can see the mode's current status.

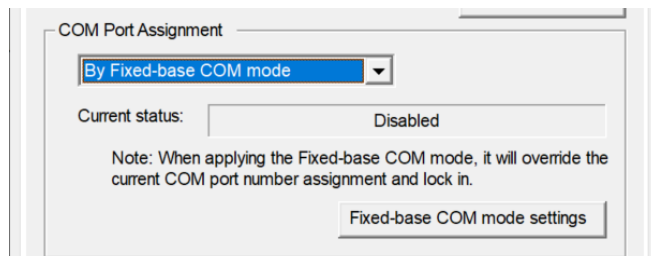

3. Click on the **Fixed-base COM mode settings** button. The UPort Configuration Tool will then be launched.

- Click on the checkbox for **Enable Fixed-base COM mode**, then select the preferred beginning COM number.

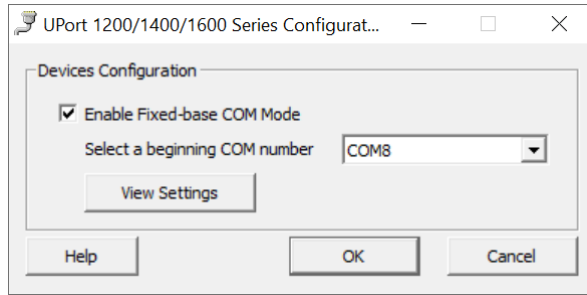

NOTE

- The port settings for **Fixed-base COM Mode** will be kept as another separate set in the driver. When it is enabled for the first time, all COM port numbers and serial port parameters for the **Fixed-base COM mode** will be set to the default values. You can set the COM numbers and configuration parameters to the values needed for your application.
- Once the Fixed-base COM mode is enabled, the COM number of port 1 of all the UPort 1200/1400/1600 and G2 models will begin with the COM number that you set, and the driver will find the available COM ports for the rest of ports. If another UPort of the same series is plugged in to the same computer, the driver will find and assign other available COM numbers in the system.
- COM port assignment will be disabled once Fixed-base COM is enabled. You will need to disable it first before you can assign COM port assignment to other options.

- Click **View Settings** to check the COM number set for all the ports of your UPort.

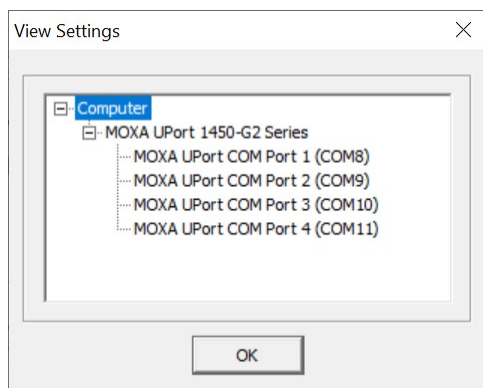

Serial PnP

Serial PnP provides better compatibility support to legacy serial devices, such as a mouse or scanner that is equipped with a serial interface. The default option is On.



NOTE

The Windows Arm platform does not support serial PnP.

Basic Settings

Auto Enumerating COM Number

If the "Auto Enumerating COM Number" checkbox is checked, the COM numbers will be assigned automatically and in sequence to the ports. E.g., COM3 to Port 1, COM4 to Port 2, etc.

If you do not enable this checkbox, only the first COM number will be changed to the new COM number list in the drop-down menu. Enable this function if you want to configure several ports with sequential numbers.

To have this option available, you need to select multiple ports in the **Select Port** column.

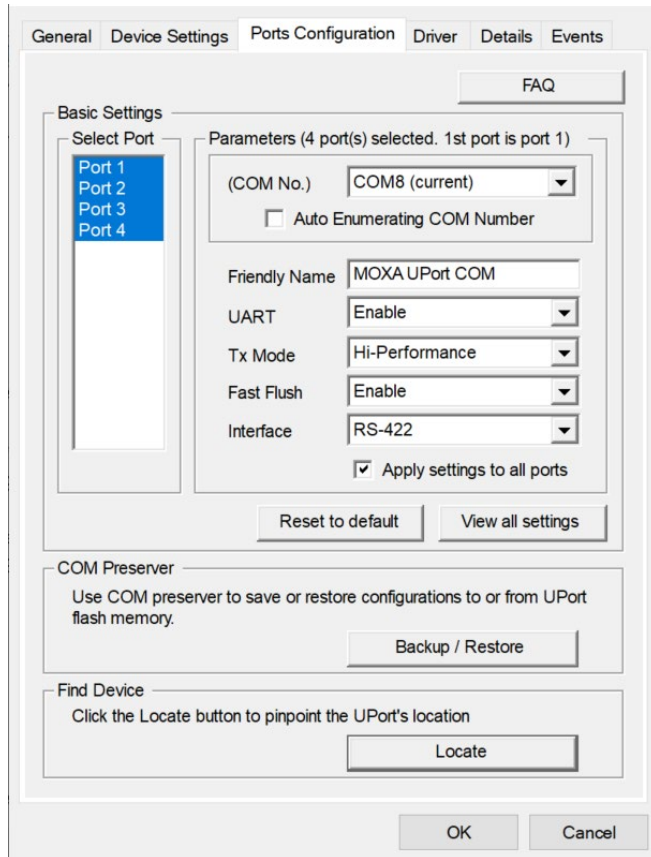

Friendly Name

Setting Options	Factory Default	Necessity
1 to 20 characters (E.g., UPort 1610-8-G2)	Moxa UPort COM	Optional

Use "Friendly name" to allow easy identification of the serial devices connected to the UPort's serial ports.

UART FIFO

Setting Options	Factory Default	Necessity
Enable/Disable	Enable	Required

The UPort's serial ports provide a 512-byte FIFO both in Tx and Rx directions. Disable the UART FIFO setting when your serial device does not have a FIFO to prevent data loss during communication. We recommend you disable FIFO if your application needs to speed up the latency time of receiving data.

Tx Mode

Setting Options	Factory Default	Necessity
Hi-performance/Classical	Hi-performance	Required

To improve the write performance, you can select **Hi-performance** mode. Under **Classical** mode, the driver will not notify the user's program that Tx is completed until all Tx data has been sent out from the UPort; this mode will cause lower throughput. If you want to ensure all data has been sent out before further processing, then **Classical** mode is recommended. **Classical** mode is similar to the behavior of native COM Port: The WriteFile() call will only finish when all queued data are sent out.

Fast Flush

Setting Options	Factory Default	Necessity
Enable/Disable	Enable	Required

1. For some applications, the user's program will use the Win32 **PurgeComm()** function before it reads or writes data. With our design, after the program uses this **PurgeComm()** function, the UPort driver will keep querying the UPort's firmware several times to make sure that no data is queued in the UPort's firmware buffer, rather than just flushing the local buffer. This kind of design is used because of some special considerations. However, it might take more time (about several hundred milliseconds) than a native COM port; therefore, the native COM ports on the motherboard can work fast with this function call, but the UPort requires much more time.
2. To begin with, make sure some **PurgeComm()** functions are being used in your application program. In some situations, you might find your UPort performs much poorer than when using the native COM port. Once you have enabled the **Fast Flush** function, check to see if there has been an improvement in performance.
3. The optional **Fast Flush** function is enabled by default, allowing the UPort driver to work faster when using the **PurgeComm()** function.
4. Win32 function **PurgeComm()** with PURGE_TXCLEAR will clear all queued Tx data. But for some applications, it will call this function for each transaction and result in a low throughput. To avoid this, you can enable this function. The driver will only clear the data queued in the local buffer; it will not send firmware through the USB port to clear the data queued in the firmware buffer.

Interface

UPort 1410-G2, 1610-8-G2

Setting Options	Factory Default	Necessity
RS-232	RS-232	Required

UPort 1450-G2, 1450I-G2, 1650-8-G2, 1650-8-G2-Hub

Setting Options	Factory Default	Necessity
RS-232, RS-422, 4-wire RS-485, 2-wire RS-485	RS-232	Required

Apply Settings to All Ports

After choosing the option and clicking the **OK** button, the port settings will apply to all other ports. So, you would only need to set the configuration once, and the driver will automatically copy the settings to other ports for you.

Reset to Default

If you click the **Reset to default** button, all the settings will return to factory default settings:

COM Number:	<Assign available COM number automatically>
Tx Mode:	Hi-Performance
UART FIFO:	Enable
Fast Flush:	Enable
Interface:	RS-232

View All Settings

You can preview all ports settings with this function.

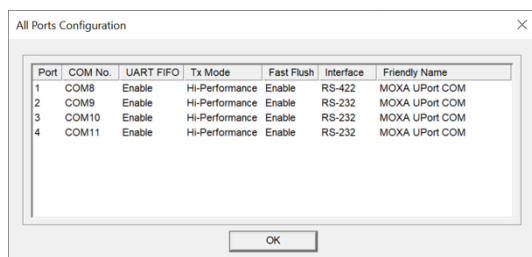

COM Preserver—Driver Setting Management

The **COM Preserver** function backs up or restores COM port settings between the driver and the UPort, requiring only one click when you need to use the same UPort on another host computer and clone the port settings to the new host.

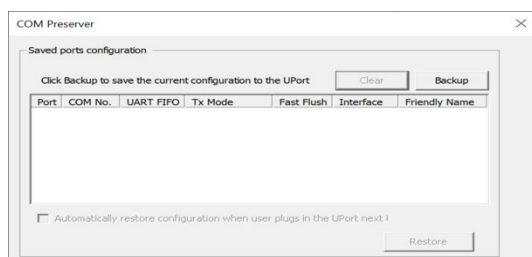

When using COM Preserver the first time, simply click the **Backup** button to save all the ports settings to the UPort. The saved port settings information will show in the table. COM number, Friendly Name, Transmission Mode, FIFO settings, Fast Flush settings, and Interface will be saved. Whenever you revisit the UPort's port settings in driver manager, the saved port settings will be shown automatically.

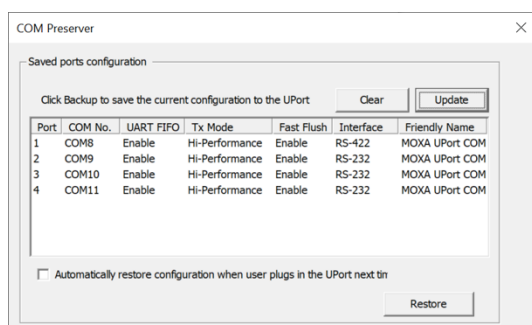

Update: This is to update changed port settings to the UPort if the current port settings are different from saved ones.

Clear: To clear the saved port settings in the UPort

Restore: To restore the saved port settings from the UPort to the driver

Automatically restore port settings when plugging in the UPort the next time: A convenient way to restore the port settings to the driver without the need to revisit the COM Preserver.



Caution

1. If you want to use these settings in another PC, be sure the PC has a free COM port available. Otherwise, the new settings will copy over the settings of a COM port that is already in use.
2. Update/Clear/Restore functions are not reversible. Please be sure your operation is as intended.

Locate

Use this function to identify the UPort's location, especially when two or more UPorts are installed on the same computer. This function will trigger the UPort to flash the ready LED and turn on the Buzzer until you stop it.

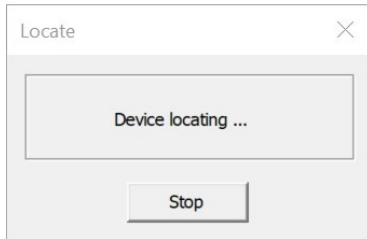

FAQ

Clicking **FAQ** will take you to online help for the UPort.

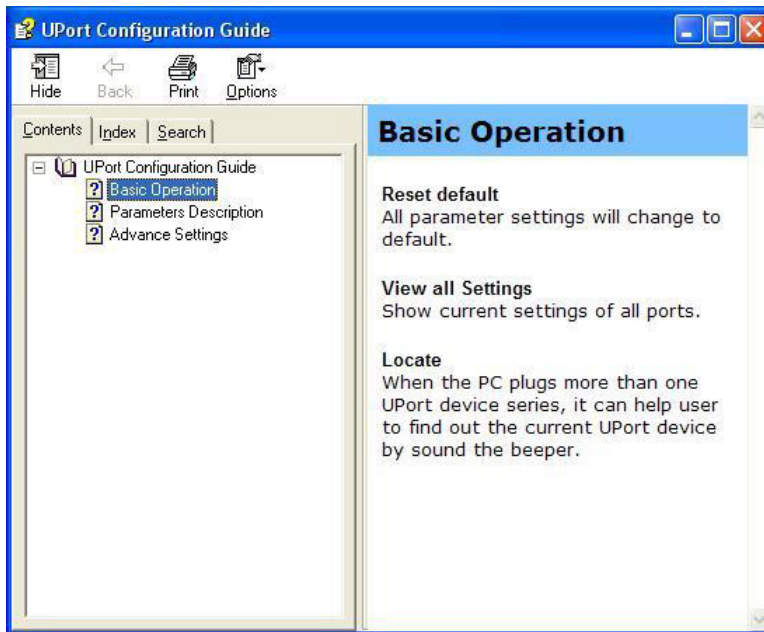

Uninstalling the UPort

If you want to remove the UPort, you just need to uninstall the device from the **Device Manager**. The UPort driver will still stay alive, enabling other UPort devices to keep working.

1. In **Device Manager**, expand the **Multi-port serial adapters** tab, right-click your UPort and then click **Uninstall** to uninstall this UPort. A window will pop up to confirm that you want to remove this UPort.

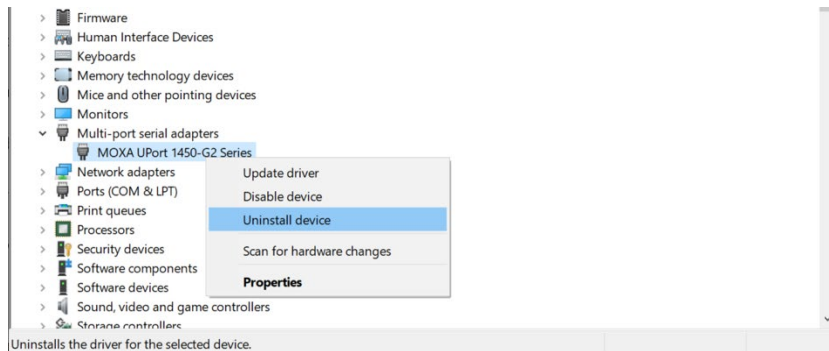

2. Check **Delete the driver software for this device** if all the settings for this UPort are no longer needed.

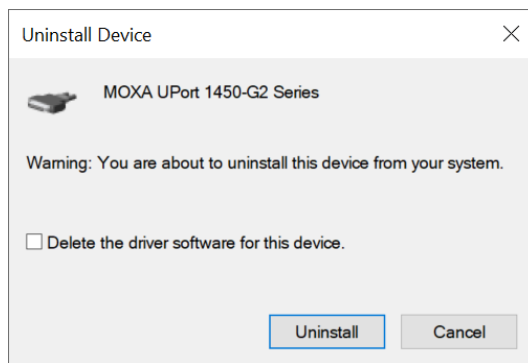

Uninstalling the Driver

1. Find Moxa **UPort Windows Driver Ver x.x** and click, select **Uninstall**.

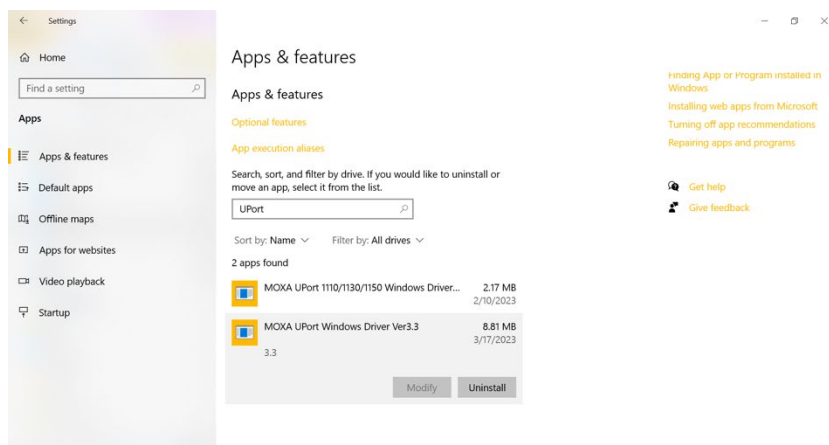

2. To uninstall the driver, in **Windows Settings**, under **Apps**, search for the UPort.

Installation Troubleshooting

When you plug in the UPort to the host computer, you will see the following showing on your screen:

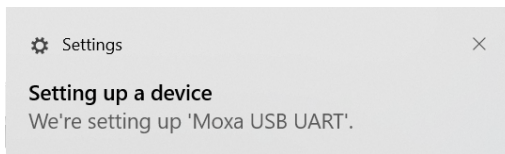

And, in Windows device manager, you would find nothing under **Multi-port serial adapters**, but there is a **Moxa USB UART** under **Other devices**.



This may mean the driver installation was unsuccessful or has not been completed. Please check if the driver supporting your OS version matches your host computer and then reinstall the driver again.

Installing the Linux Driver

For x86 based platform

The Linux driver, provided with the UPort 1200/1400/1600-G2, maps Linux host ttyUSBxx ports to UPort device ports. Once the mapping has been set up, Linux users and applications can connect to a device port as if it were a ttyUSBxx port. These drivers have been designed and tested for most Linux distributions. Please check Moxa's website (<http://www.moxa.com>) for the latest Linux kernel support.

Installing the Moxa Driver

First get the Linux driver file `moxa-uport-1200-1400-1600-g2-series-linux-kernelx.x-driver-vx.x.tgz` from the Moxa website at <http://www.moxa.com>. Save the driver file to a specific directory, such as `/moxa`, and then execute the commands listed below to extract the files:

```
# cd /moxa
```

```
# tar xvzf moxa-uport-1200-1400-1600-G2-series-linux-kernelx.x-driver-vx.x.tgz
```

To install the Moxa driver, change to the `mxuport` directory. Next, run the command as follows:

```
# ./mxinstall
```

After installing the Moxa driver, plug the UPort device into the host. Run the following command to check the Moxa serial port.

```
# ls /dev/ttyUSB*
```



NOTE

The serial COM port will be `ttyUSB[nnn]`, `nnn = 0~255`. For example, `ttyUSB0`, `ttyUSB1` ...

Uninstall Driver

To uninstall the Moxa driver, change to the `/moxa/mxuport` directory, and then run the `ls` (list) command to check if the **Makefile** file is in the directory. Next, run the command as follows:

```
# make remove
```

Setting the Serial Parameters

After installing the Moxa Linux Driver, you will be able to configure parameters.

1. Serial Interface:

The UPort 1200-G2/1400-G2/1600-8-G2 Series supports four interfaces: RS-232, RS-485 2W, RS-485 4W, RS-422. If you want to switch to a different interface, execute the `set serial` command to set the port's interface. The supported parameters are listed below.

Parameter Value	Interface
0x0	RS-232
0x1	RS-485 2W
0x2	RS-422
0x3	RS-485 4W

Example:

a. The following command sets the interface of `/dev/ttyUSBx` to RS-422:

```
# setserial /dev/ttyUSB0 port 0x2
```

b. Use the following command to look up the serial settings of the current port:

```
# setserial -g /dev/ttyUSB0
```

2. Serial Baudrate:

`spd_hi` Use 57.6 kbs instead of 38.4 kbs
`spd_vhi` Use 115.2 kbs instead of 38.4 kbs.
`spd_shi` Use 230 kbs instead of 38.4 kbs.
`spd_warp` Use 460 kbs instead of 38.4 kbs.
`spd_normal` Use 38.4 kbs instead of 38.4 kbs.

Example:

```
# setserial /dev/ttyUSB0 spd_vhi
```



NOTE

For the UPort with DB9 male serial ports, you may refer to the DB9 male ports pin assignment section to loop back pin 2 and pin 3 for the RS-232 interface to carry out a self-test on the device.

For Arm-based platform

Please refer to tech note for the Arm-based driver installation. Go to the UPort 1200/1400/1600-G2 Series product web page and look for the PDF file named **Moxa UPort Driver Arm-based Platform Porting Guide** for further details.

Installing the Mac Driver for macOS

For macOS 10.12 and later, follow the steps below to install the driver.

1. Restart your Mac and enter Recovery Mode by pressing and holding `⌘ + R`.
2. Disable System Integrity Protection (SIP) by typing `'csrutil disable'` in the terminal.
3. Return to Normal Mode.
4. Launch the UPort driver installer and finish the installation procedures shown below.
5. Enter Recovery Mode again.
6. Enable System Integrity Protection (SIP) by typing `'csrutil enable'` in the terminal.
7. Return to Normal Mode.

Installation Procedure

Run the installer package, which you can find on Moxa's support website <http://www.moxa.com/support/>. Follow the steps to install the driver. A few things to note:

1. Under **Read Me**, see the instructions for installation and troubleshooting.

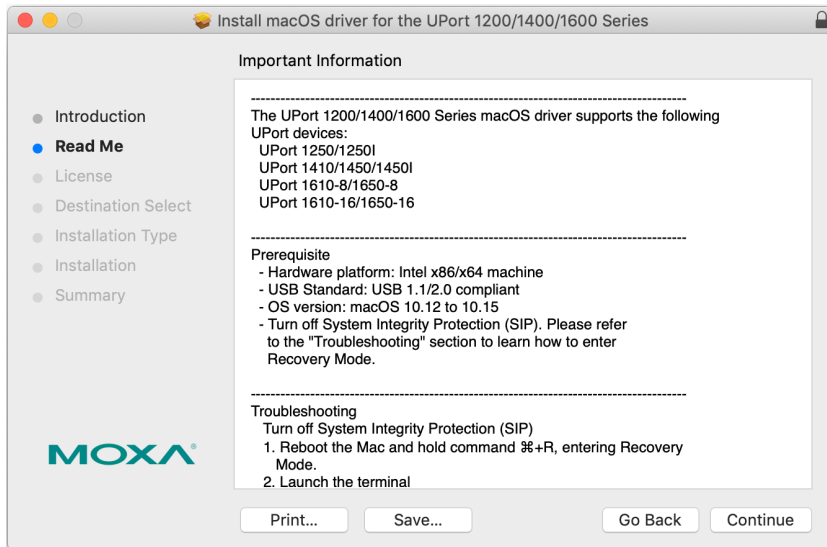

2. Please read the Software License Agreement.

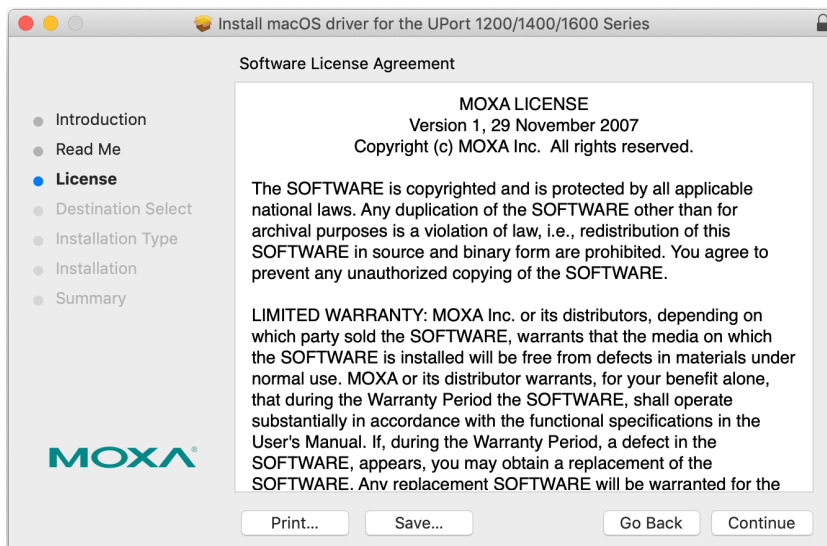

3. When you reach the **Summary** step, the installation is completed.

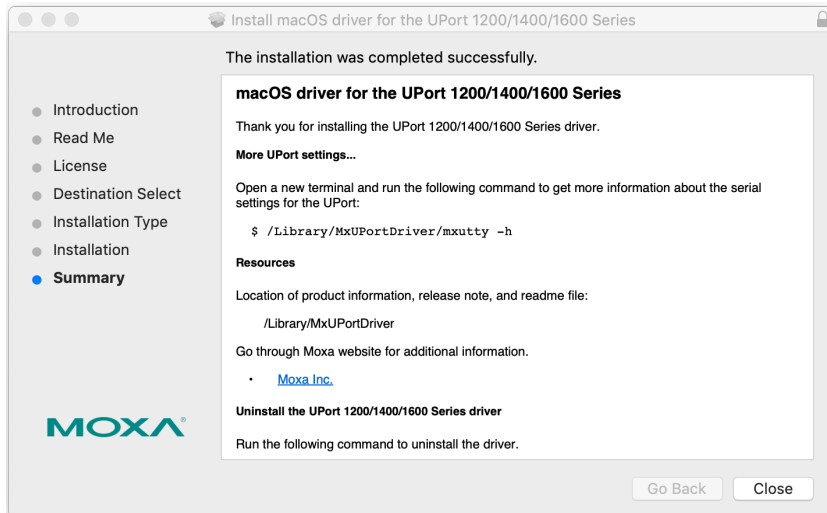

Installation Troubleshooting

If the installation encounters an error message such as below, please check your System Integrity Protection (SIP) by executing the **csrutil status** in the terminal. If it is enabled, please disable it and try to install it again.

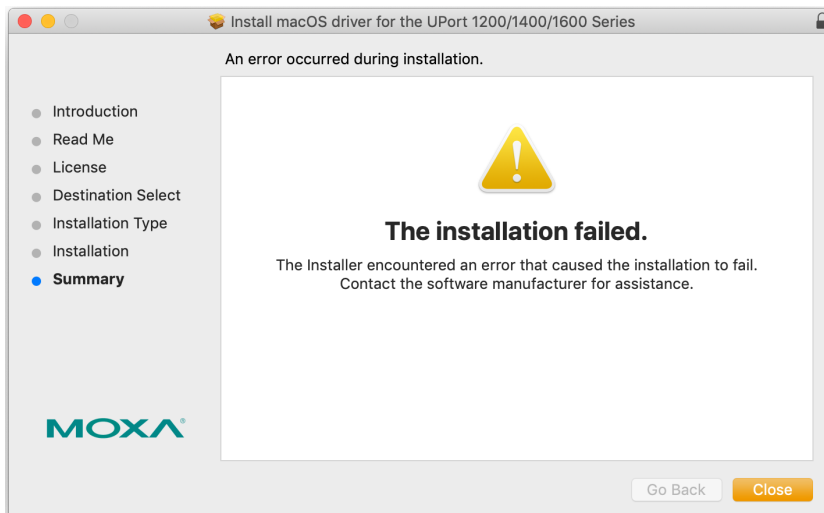

If you cannot install the driver on macOS 10.15 successfully, starting with macOS 10.15 Catalina, Apple has introduced a new read-only protection that does not allow users to install the driver directly in the kernel folder. To solve this issue, please type the following command in Terminal before installation:

```
$ sudo mount -uw /
```

3. Useful Companion Utilities

ViewCOM

ViewCOM is a handy tool that helps check the current COM port assignment with a quick glance and shortcut to Windows Driver Manager to adjust the port's parameter.

ViewCOM does not require installation. The execution file can be clicked and run on any version of Windows. You may get the utility either from the UPort's installer, or from the **MOXA.com** <https://www.moxa.com/support/product-support/software-and-documentation>

When ViewCOM is launched, it can be found in the system tray.

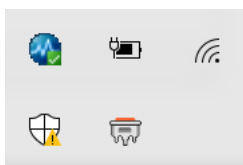

When you mouse over the ViewCOM icon, you will find the product and its COM port information.

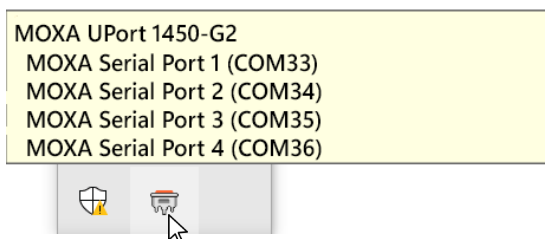

The context menu when you right-click has the shortcut to Windows Device Manager and Auto Startup if needed.

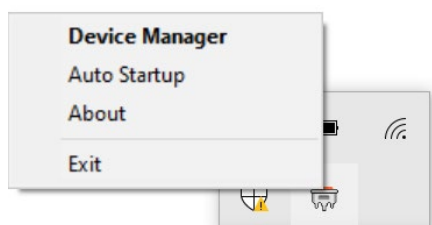









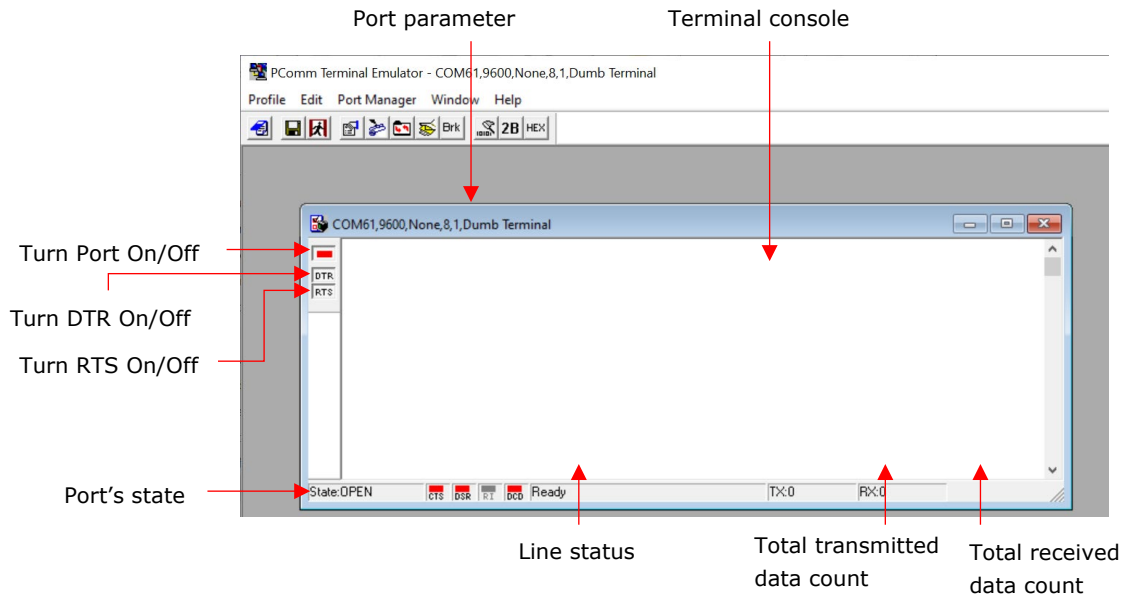



PComm Terminal Emulator

PComm Terminal Emulator simulates serial data communication. It is often used as a testing/troubleshooting tool when setting up the device for the first time, or when the communication seems not to be working.

PComm Terminal Emulator does not require an installer and the application can be executed on any Windows version.

1. Run PComm Terminal Emulator in **Start > All apps > Moxa > PComm Terminal Emulator**, or **/Program Files/Moxa/PCommLite {version}/Utility/mxterm.exe**.



	Open COM port(s)
	Save current PComm profile
	Exit the program
	Serial port parameters
	Clear terminal console
	Transferring a file
	Sending pattern
	Stop the operation
	Capturing receiving text to a file
	Display double byte character
	Display data in hexadecimal format

- Click **Open** to select which COM port to check.

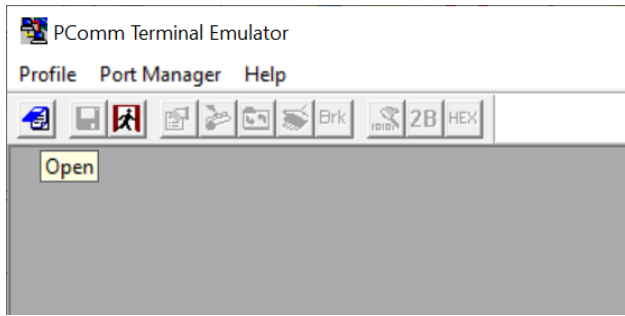

- Choose your desired **Baud rate, Data bits, Parity, Stop bits, and Flow control.**

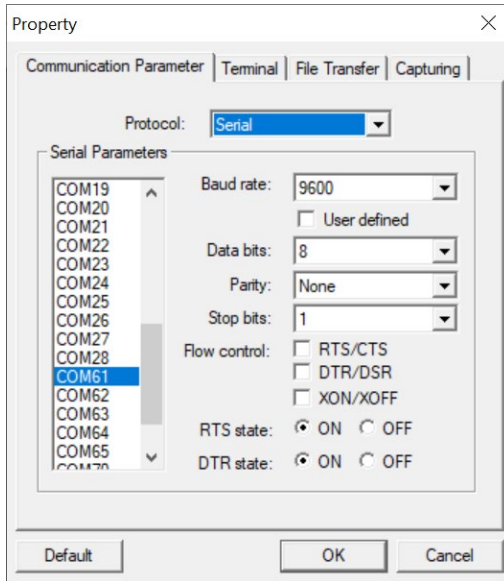

NOTE

- UPort 1200/1400/1600 and G2 support any baud rate, enable **User defined**, and input the desired baud rate in the field.
- You may select multiple ports by pressing and holding Ctrl with a left-click.

- Plug in the loopback connector **LB-DB9F-G-01**, which comes in the box, to the corresponding serial port to the COM port that you selected in step 3.
- Check if the port is enabled and state is open.

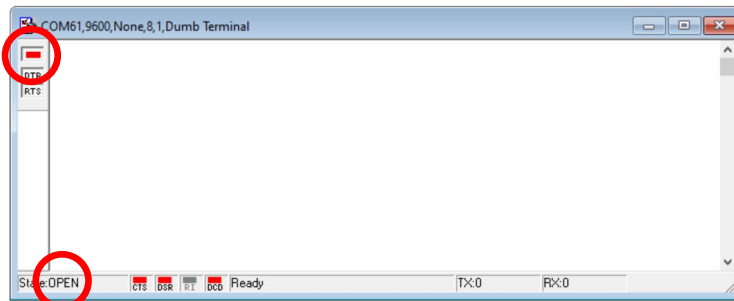

- Click **Send Pattern**.

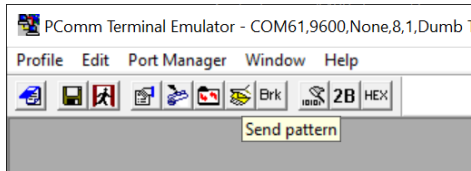

- Select which data pattern you would like to test and how many counts you want to send. In this example, **ASCII** is used and **Repeat count** is set to 1. Then click **Start Send**.

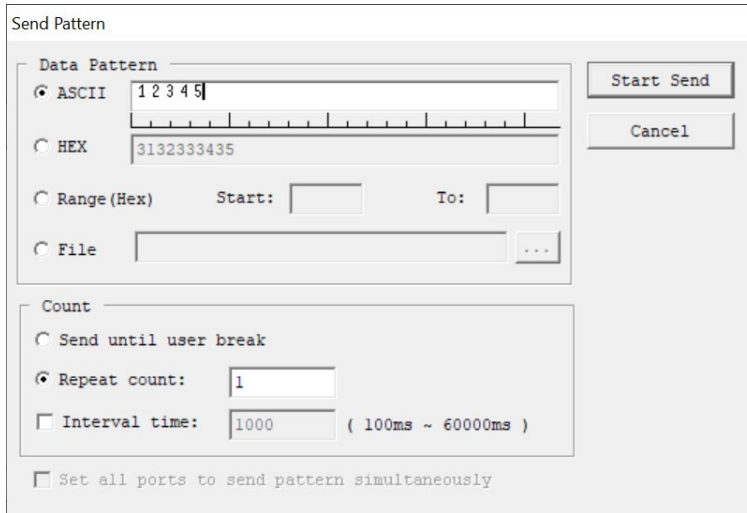

ASCII: Sending ASCII value.

HEX: Sending HEX value.

Range (HEX): Sending a range of HEX values from starting value (**Start:**) to ending value (**To:**)

File: Sending a file—if it is a plain text file, the text will be shown in the terminal window in a readable format.

Set all ports to send pattern simultaneously: When multiple ports are opened, **Send Pattern** can send the data to all the ports at the same time.

- If the result showing in the terminal console is exactly the value that you have just entered in **ASCII** in step 7, then congratulations: You have established the communication successfully. You may also check if the TX count matches the RX count; this will tell you if there is any data lost during the test.

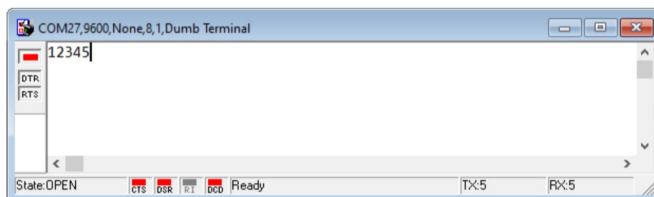

File Transfer

File transfer provides transmitting or receiving file through various file transferring protocols.

1. Click **File Transfer**.

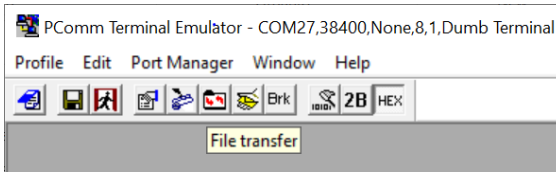

2. Select which file transfer protocol. Next, select transmitting or receiving a file.

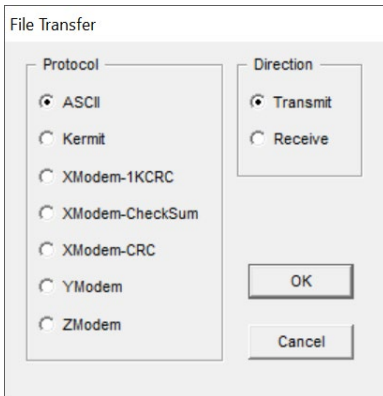

3. When the file selector appears, select the file that you wish to transmit or the folder that you would like to place the receiving file.

Capture

Capture saves received text to a file. The file saving path can be changed in **Property > Capturing**. The default folder is **\Documents**.

Click **Capture** on the toolbar to capture.

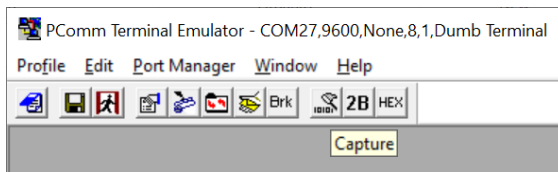

NOTE

If you are capturing the data from **Send Pattern**, you need to start **Capture** before **Send Pattern** is in action.

A. How to Become a Registered User of Moxa Website

Why should you become a Moxa.com registered user? It benefits you to receive all updates to your purchased product or product of interest, including all software, such as firmware, driver, etc., and all documentations, such as datasheets, Quick Installation Guides (QIGs).

To become a registered user, you need to do following:

Register a Moxa account

1. Go to Moxa.com and click 'Sign in' at the top right corner.

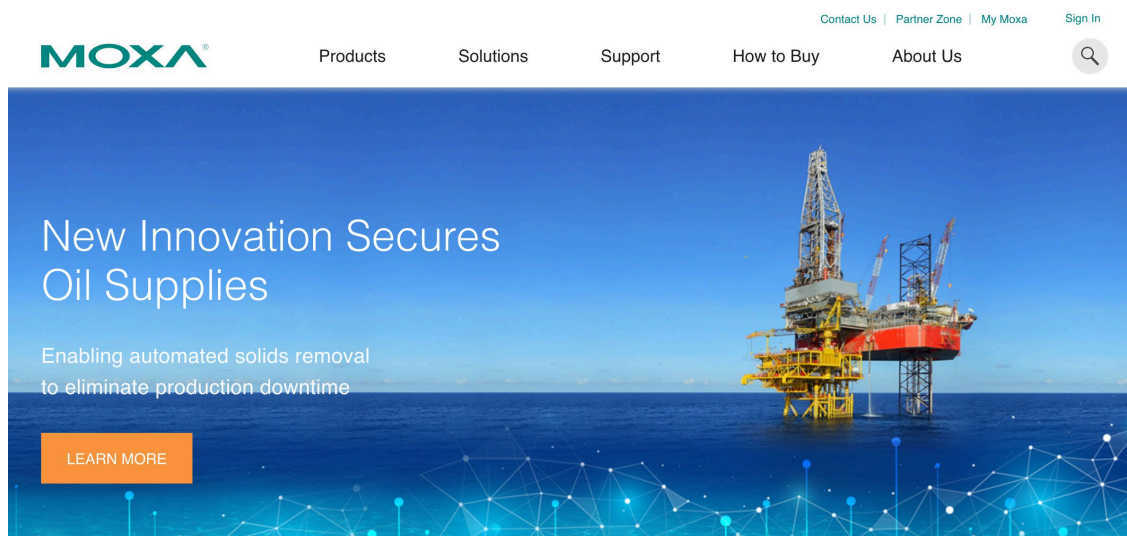

2. In the Sign In page, click "[Create your Moxa member account](#)" as below.

Please sign in

Email*

Password*

[Forgot your password?](#)

SIGN IN

Not a member? [Create your Moxa member account](#)

3. Fill in the necessary fields.

Create New Account

Work Email*

First Name* Last Name*

Company*

Phone*

Region*

Please input a password*

Request for product updates

1. Go to the product's page that you would like to receive updates, click **" + FOLLOW UPDATE "**

The screenshot shows the product page for the Moxa UPort 1600-8-G2 Series. The page includes a navigation menu, a breadcrumb trail, and a list of features and benefits. The '+ FOLLOW UPDATES' button is highlighted.

MOXA Products Solutions Support How to Buy About Us Contact Us Partner Zone My Moxa Sign In

Home > Products > Industrial Edge Connectivity > USB-to-Serial Converters/USB Hubs > USB-to-Serial Converters > UPort 1600-8-G2 Series

UPort 1600-8-G2 Series

8-port RS-232/422/485 USB-to-serial converters

Features and Benefits

- USB 3.2 SuperSpeed capability
- 512-byte on-chip FIFO cache and flow control for enhanced performance
- Drivers provided for a broad selection of operating systems, including Windows and Linux
- 50 bps to 921.6 kbps baudrate (nonstandard baudrates supported)
- Double-sided LEDs located at the corners show power, TX, and RX statuses in either directions
- Cascading of up to 32 ports without requiring additional power adaptors
- Latching USB cable design for firmer connection
- Wide operating temperature models available for -40 to 75°C (-40 to 167°F) environments
- Serial port with 2 kV isolation protection (for "I" models)

Certifications

CE FCC UL USB RoHS

GET A QUOTE + FOLLOW UPDATES

2. Once completed, see the FOLLOW UPDATES button changing.

The screenshot shows the 'GET A QUOTE' button and the 'FOLLOWING' button. The 'FOLLOWING' button is highlighted.

GET A QUOTE FOLLOWING i