

# UC-2100 Series Quick Installation Guide

---

**Version 3.2, January 2021**

**Technical Support Contact Information**  
[www.moxa.com/support](http://www.moxa.com/support)

**MOXA®**

© 2021 Moxa Inc. All rights reserved.

**P/N: 1802021000114**



## Overview

The UC-2100 Series computing platform is designed for embedded data acquisition and processing applications. The computer comes with up to two software-selectable RS-232/422/485 full-signal serial ports and single or dual Ethernet LAN ports. In addition, the Arm-based computing platform is available in various models that can fulfill diverse interface requirements, such as single and dual serial, LAN ports, and gigabit Ethernet, and wireless connections. These versatile communication capabilities let users efficiently adapt the palm-sized UC-2100 computing platform to a variety of complex communications solutions.

## Model Names and Package Checklist

The UC-2100 Series includes the following models:

**UC-2101-LX:** Palm-sized industrial computing platform with 1 serial port, 1 Ethernet port, -10 to 60°C operating temperature

**UC-2102-LX:** Palm-sized industrial computing platform with 2 Ethernet ports, -10 to 60°C operating temperature

**UC-2104-LX:** Palm-sized industrial computing platform with 1 Mini PCIe socket for wireless module, 1 Ethernet port, -10 to 70°C operating temperature

**UC-2111-LX:** Palm-sized industrial computing platform with 2 serial ports, 2 Ethernet ports, Micro SD socket, -10 to 60°C operating temperature

**UC-2112-LX:** palm-sized industrial computer with 1 GHz processor, 2 serial ports, 2 Ethernet ports (1 gigabit Ethernet), Micro SD socket, -10 to 60°C operating temperature

**UC-2112-T-LX:** Palm-sized industrial computing platform with 1 GHz processor, 2 serial ports, 2 Ethernet ports (1 gigabit Ethernet), Micro SD socket, -40 to 75°C operating temperature

Before installing a UC-2100 computer, verify that the package contains the following items:

- UC-2100 Series computer
- Console cable
- Power jack
- Quick Installation Guide (printed)
- Warranty card

*Notify your sales representative if any of the above items are missing or damaged.*

**NOTE** The console cable and power jack can be found beneath the molded pulp cushioning inside the product box.

# Appearance

## UC-2101

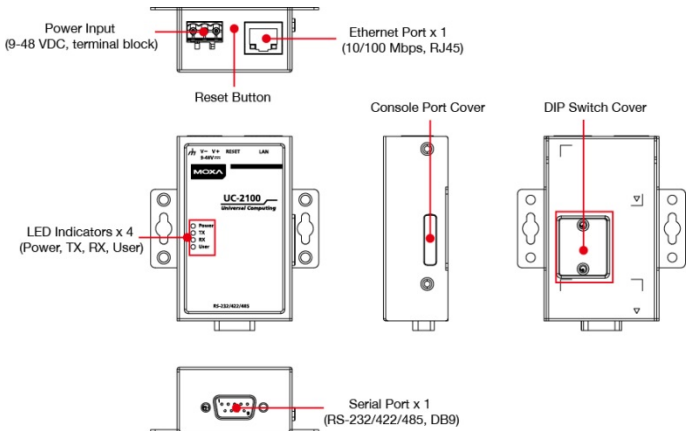

## UC-2102

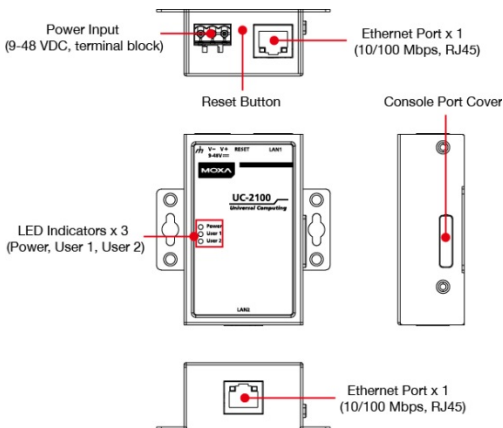

## UC-2104

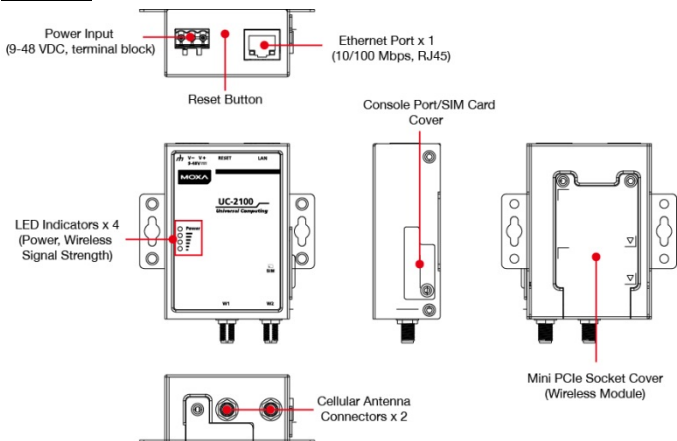

## UC-2111

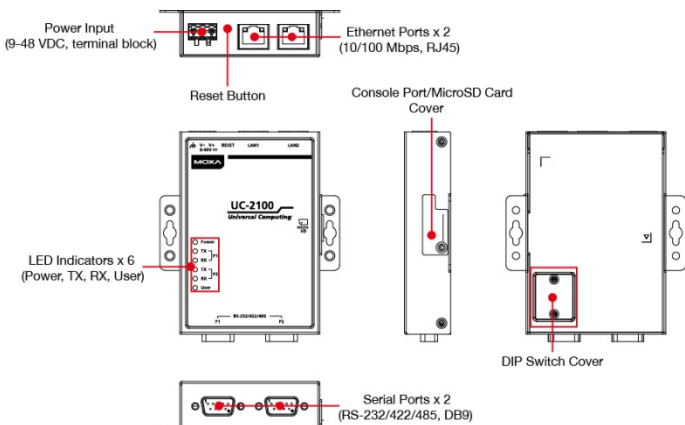

## UC-2112

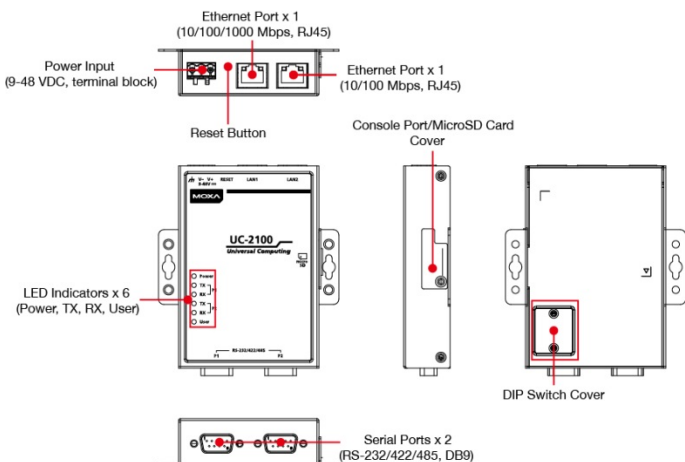

## LED Indicators

The function of each LED is described in the table below:

LED Name	Status	Function
<b>Power</b>	Green	Power is on, and the device is functioning normally
	Off	Power is off
<b>Ethernet</b>	Green	Steady On: 10 Mbps Ethernet link Blinking: Data transmission is in progress
	Yellow	Steady On: 100 Mbps Ethernet link Blinking: Data transmission is in progress
	Off	Speed lower than 10 Mbps or the cable is not connected
	Green (UC-2112 only)	Steady On: 100 Mbps Ethernet link Blinking: Data transmission is in progress
	Yellow (UC-2112 only)	Steady On: 1000 Mbps Ethernet link Blinking: Data transmission is in progress
<b>Serial (Tx)</b>	Green	Serial port is transmitting data
	Off	Serial port is not transmitting data
<b>Serial (Rx)</b>	Yellow	Serial port is receiving data
	Off	Serial port is not receiving data
<b>User</b>	Green	User Programmable
<b>LEDs that indicate the Wireless signal strength</b>	Yellow	The number of glowing LEDs indicates the signal strength 3 LEDs: Excellent 2 LEDs : Good 1 LED : Poor
	Off	Wireless module is not detected

## Reset Button

The UC-2100 panel computer is provided with a reset button, which is located on the top panel of the computer. To reboot the computer, press the reset button for 1 second. Press and hold the reset button between 7 to 9 seconds to reset the computer to the factory default settings. When the reset button is held down, the **User** LED (the first signal LED on UC-2104) will blink once every second. The **User** LED will become steady when you hold the button continuously for 7 to 9 seconds. Release the button within this period to load the factory default settings.

## Installing the Computer

### Wall or Cabinet Mounting

Use two screws per side to mount the UC-2100 Series on a wall or inside a cabinet.

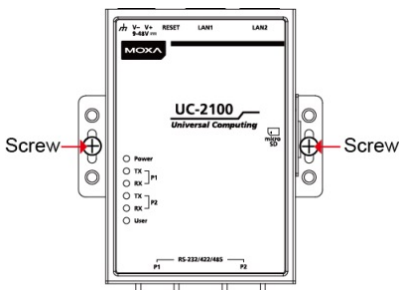

## **Wiring Requirements**

Be sure to read and follow these common safety precautions before proceeding with the installation of any electronic device:

- Use separate paths to route wiring for power and devices. If power wiring and device wiring paths must cross, make sure the wires are perpendicular at the intersection point.

**NOTE** Do not run signal or communication wiring and power wiring in the same wire conduit. To avoid interference, wires with different signal characteristics should be routed separately.

- Use the type of signal transmitted through a wire to determine which wires should be kept separate. The rule of thumb is that wiring that shares similar electrical characteristics can be bundled together.
- Keep input wiring and output wiring separate.
- It is strongly advised that you label wiring to all devices for easy identification.



### **ATTENTION**

This equipment is intended to be used in Restricted Access Locations.

#### **Safety First!**

Be sure to disconnect the power cord before installing and/or wiring your UC-2100 Series computers.

#### **Wiring Caution!**

Calculate the maximum possible current in each power wire and common wire. Observe all electrical codes dictating the maximum current allowable for each wire size. If the current goes above the maximum ratings, the wiring could overheat, causing serious damage to your equipment.



### **CAUTION**

Be careful when handling the unit. When the unit is plugged in, the internal components generate heat, and consequently the outer casing may feel hot to the touch.

## **Connecting the Power**

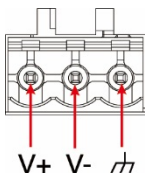

Connect the 9 to 48 VDC power line to the terminal block, which is connected to the UC-2100 Series computer. If the power is supplied properly, the "Power" LED will glow a solid green light. The power input location and pin definition are shown in the adjacent diagram. The input terminal block (CN5) is suitable for a wire size of 12 to 30 AWG (3.3 to 0.05 mm<sup>2</sup>) and a torque value of 0.5 N·m (4.425 lb-in).



Input Rating: 9 to 48 VDC, 0.45 to 0.084 A

## Grounding the Unit

Grounding and wire routing help limit the effects of noise due to electromagnetic interference (EMI). Run the ground connection from the terminal block connector to the grounding surface prior to connecting the power. Please note that this product is intended to be mounted on a well-grounded mounting surface, such as a metal panel. The minimum cross-sectional area of the earthing conductor shall be equal to the input wiring cable.

## Connecting to the Console Port

The UC-2100 console port is a 4-pin pin-header RS-232 port located on the right panel of the case. It is designed for serial console terminals, which are useful for viewing the boot up message, or for debugging system boot up issues. Remove the protective cover on the port to connect the console cable.

Serial Console Port & Pinouts		Serial Console Cable											
4		<table border="1"><thead><tr><th>Pin</th><th>Signal</th></tr></thead><tbody><tr><td>1</td><td>TxD</td></tr><tr><td>2</td><td>RxD</td></tr><tr><td>3</td><td>NC</td></tr><tr><td>4</td><td>GND</td></tr></tbody></table>	Pin	Signal	1	TxD	2	RxD	3	NC	4	GND	
Pin	Signal												
1	TxD												
2	RxD												
3	NC												
4	GND												

## Connecting to the Network

The Ethernet ports are located on the top or bottom panel of the UC-2100 computers. The pin assignments for the Ethernet port are shown in the following figure. If you are using your own cable, make sure that the pin assignments on the Ethernet cable connector match the pin assignments on the Ethernet port.

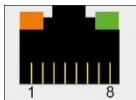

The LED indicator on the upper right corner glows a solid green color when the computer establishes a connection with a 100 Mbps Ethernet network.

Pin	Signal
1	ETx+
2	ETx-
3	ERx+
4	-
5	-
6	ERx-
7	-
8	-

The LED will flash on and off when Ethernet packets are being transmitted or received.

The LED indicator in the upper left corner glows a solid orange color when the computer establishes a connection with a 10 Mbps Ethernet network.

The LED will flash on and off when Ethernet packets are being transmitted or received.

For the UC-2112 model, refer to the following detailed pin definitions for the gigabit Ethernet port.

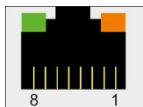

The LED indicator in the upper left corner glows a solid green color when the computer establishes a connection with a 100 Mbps Ethernet network.

The LED will flash on and off when Ethernet packets are being transmitted or received.

The LED indicator in the upper right corner glows a solid orange color when the computer establishes a connection with a 1000 Mbps Ethernet network.

The LED will flash on and off when Ethernet packets are being transmitted or received.

Pin	Signal
1	MDI0+
2	MDI0-
3	MDI1+
4	MDI2+
5	MDI2-
6	MDI1-
7	MDI3+
8	MDI3-

## Connecting to a Serial Device

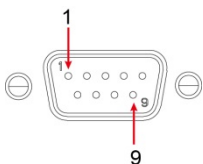

The serial ports are located on the bottom panel of the UC-2100 computer. Use a serial cable to connect your serial device to the computer's serial port. These serial ports have male DB9 connectors and can be configured for RS-232, RS-422, or RS-485 communication. The pin location and assignments are shown in the following table.

Pin	RS-232	RS-422	RS-485 (4-wire)	RS-485 (2-wire)
1	DCD	TxDA(-)	TxDA(-)	-
2	RxD	TxDB(+)	TxDB(+)	-
3	TxD	RxDB(+)	RxDB(+)	DataB(+)
4	DTR	RxDA(-)	RxDA(-)	DataA(-)
5	GND	GND	GND	GND
6	DSR	-	-	-
7	RTS	-	-	-
8	CTS	-	-	-

## Connecting the Cellular/Wi-Fi Module and Antenna

The UC-2104 computer comes with one Mini PCIe socket for installing one cellular or Wi-Fi module. Unfasten the two screws on the rear panel and one screw on the bottom panel to remove the cover and find the location of the socket.





The cellular module package includes 1 cellular module and 2 screws. The cellular antennas should be purchased separately to fit your installation requirements.

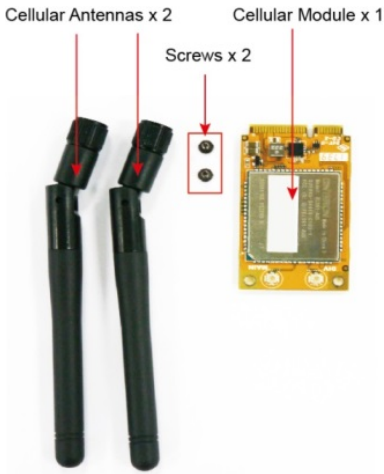

Follow these steps to install the cellular module.

1. Set the antenna cables aside and clear the wireless module socket as shown in the figure for convenience of installation.
2. Insert the cellular module into the socket and fasten two screws (in the package) on to the top of the module
3. Connect the free ends of the two antenna cables next to the screws as shown in the image.
4. Replace the cover and secure it using the three screws.  
(Use of a tweezer is recommended when installing or removing the module)
5. Antenna connectors are located on the top panel of the computer. Connect the cellular antennas to the connectors.

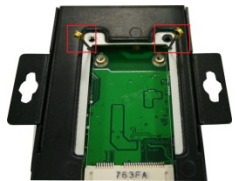

The Wi-Fi module package includes 1 Wi-Fi module and 2 screws. The antenna adapters and Wi-Fi antennas should be purchased separately to fit your installation requirements.

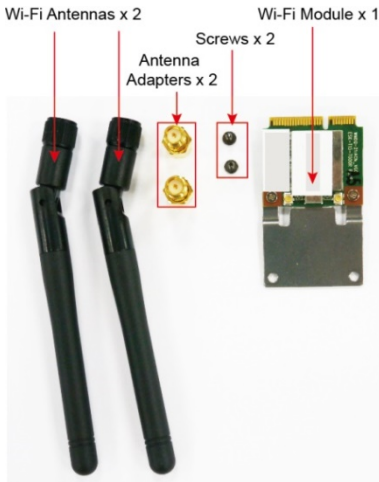

Follow these steps to install a Wi-Fi module.

1. Set the antenna cables aside and clear the wireless module socket as shown in the figure for convenience of installation.
2. Insert the Wi-Fi module into the socket and fasten the two screws (in the package) on to the top of the module.
3. Connect the free ends of the two antenna cables next to the screws as shown in the image.
4. Replace the cover and secure it with the three screws.  
(We recommend using a tweezer when installing or removing the module)
5. Connect the antenna adapters to the connectors on the top panel of the computer.
6. Connect the Wi-Fi antennas to the antenna adapters.

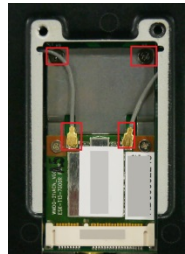
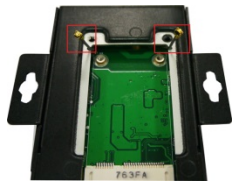

## Installing SIM Cards

You will need to install a SIM card on your UC-2104 computer. Follow these steps to install the SIM card.

1. Remove the screw on the cover located on the right panel of the UC-2104.
2. Insert the SIM card into the socket. Make sure you place the chip-side on the bottom.
3. To remove the SIM card, simply push the SIM card and release it.



## Installing the MicroSD Card

Both UC-2111 and UC-2112 Series come with a storage socket that allows users to install one MicroSD card. Follow these steps to install the MicroSD card:

1. The MicroSD socket is located below the right panel of the computer. Unfasten the screw and remove the right panel cover.
2. Insert the MicroSD card into the socket. Ensure that the card is inserted in the right direction.
3. Replace the cover and fasten the screw on the cover to secure the cover.



To remove the MicroSD card, simply push the card in and release it.

## Adjusting the DIP Switch



The UC-2101, UC-2111, and UC-2112 Series computers come with one DIP switch for users to adjust the serial port parameters. To set up the DIP switch, do the following:

1. Remove the screws on the DIP switch cover located on the rear panel of the computer.
2. Remove the thin film on the DIP switch and adjust the setting as required.

Refer to the table below for the DIP switch settings. The default value is OFF.

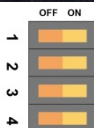
SW	1	2	3	4
	Low	High	Term.	N/A
ON	1K $\Omega$	1K $\Omega$	120 $\Omega$	N/A
OFF	150K $\Omega$	150K $\Omega$	N/A	N/A



<b>ATEX Information</b>	  II 3 G DEMKO 18 ATEX 2087X Ex nA IIC T4 Gc Ambient Range : $-10^{\circ}\text{C} \leq T_{\text{amb}} \leq 60^{\circ}\text{C}$ (For UC-2112-YY-ZZZZZ models) Ambient Range : $-40^{\circ}\text{C} \leq T_{\text{amb}} \leq 75^{\circ}\text{C}$ (For UC-2112-T-YY-ZZZZZ models) Rated Cable Temp $\geq 83.9^{\circ}\text{C}$
<b>Manufacturer's Address</b>	No. 1111, Heping Rd., Bade Dist., Taoyuan City 334004, Taiwan
<b>Hazardous Location Certifications</b>	EN 60079-0:2012+A11:2013/IEC 60079-0:2011 Ed.6 EN 60079-15:2010/IEC 60079-15:2010 Ed.4
<b>Temperature Code (T-code)</b>	T4



### ATTENTION

- The equipment shall only be used in an area of not more than pollution degree 2, as defined in IEC/EN 60664-1.
- The equipment shall be installed in an enclosure that provides a degree of protection not less than IP 54 in accordance with IEC/EN 60079-15 and accessible only by the use of a tool.
- These devices are open-type devices that are to be installed in an enclosure with tool removable cover or door, suitable for the environment.
- This equipment is suitable for use in Class I, Division 2, Groups A, B, C, and D or non-hazardous locations only



### CAUTION

Risk of explosion if battery is replaced by an incorrect type.  
Dispose of used batteries according to local regulations.



### IMPORTANT!

Equipment is intended to be supplied by an UL Listed external power supply, whose output meets SELV and LPS and is rated at 9 to 48 VDC, minimum 0.45 to 0.084 A, and minimum  $T_{\text{ma}} = 75^{\circ}\text{C}$ .