

EDS-828 Series User's Manual

Edition 3.1, June 2016

www.moxa.com/product

MOXA®

© 2016 Moxa Inc. All rights reserved.

EDS-828 Series User's Manual

The software described in this manual is furnished under a license agreement and may be used only in accordance with the terms of that agreement.

Copyright Notice

© 2016 Moxa Inc. All rights reserved.

Trademarks

The MOXA logo is a registered trademark of Moxa Inc.
All other trademarks or registered marks in this manual belong to their respective manufacturers.

Disclaimer

Information in this document is subject to change without notice and does not represent a commitment on the part of Moxa.

Moxa provides this document as is, without warranty of any kind, either expressed or implied, including, but not limited to, its particular purpose. Moxa reserves the right to make improvements and/or changes to this manual, or to the products and/or the programs described in this manual, at any time.

Information provided in this manual is intended to be accurate and reliable. However, Moxa assumes no responsibility for its use, or for any infringements on the rights of third parties that may result from its use.

This product might include unintentional technical or typographical errors. Changes are periodically made to the information herein to correct such errors, and these changes are incorporated into new editions of the publication.

Technical Support Contact Information

www.moxa.com/support

Moxa Americas

Toll-free: 1-888-669-2872
Tel: +1-714-528-6777
Fax: +1-714-528-6778

Moxa Europe

Tel: +49-89-3 70 03 99-0
Fax: +49-89-3 70 03 99-99

Moxa India

Tel: +91-80-4172-9088
Fax: +91-80-4132-1045

Moxa China (Shanghai office)

Toll-free: 800-820-5036
Tel: +86-21-5258-9955
Fax: +86-21-5258-5505

Moxa Asia-Pacific

Tel: +886-2-8919-1230
Fax: +886-2-8919-1231

Table of Contents

1. Introduction	1-1
Overview	1-2
Package Checklist	1-2
Features	1-2
Recommended Software and Accessories.....	1-3
2. Getting Started	2-1
RS-232 Console Configuration (115200, None, 8, 1, VT100)	2-2
Configuration by Telnet Console	2-4
Configuration by Web Browser	2-5
Disabling Telnet and Browser Access.....	2-6
3. Featured Functions	3-1
Overview	3-2
Configuring Basic Settings	3-2
System Identification.....	3-2
Password	3-4
Accessible IP.....	3-5
Port	3-6
Network	3-7
Time	3-8
IEEE 1588 PTP	3-9
How Does an Ethernet Switch Affect 1588 Synchronization?	3-9
System File Update—By Remote TFTP	3-11
System File Update—By Local Import/Export	3-12
System File Update—By Backup Media	3-13
Restart.....	3-13
Factory Default	3-13
Using Port Trunking	3-14
The Port Trunking Concept	3-14
Configuring Port Trunking.....	3-15
Configuring SNMP	3-16
SNMP Read/Write Settings.....	3-17
Trap Settings.....	3-18
Private MIB information.....	3-19
Using Communication Redundancy	3-19
Gigabit Ethernet Redundant Ring Capability (< 50 ms)	3-20
The Turbo Ring Concept	3-20
Configuring “Turbo Ring” and “Turbo Ring V2”	3-24
The Turbo Chain Concept	3-27
Configuring “Turbo Chain”	3-28
The STP/RSTP Concept	3-30
Configuring STP/RSTP.....	3-34
Using Traffic Prioritization	3-36
The Traffic Prioritization Concept.....	3-36
Configuring Traffic Prioritization	3-38
Using Virtual LAN.....	3-41
The Virtual LAN (VLAN) Concept.....	3-41
Sample Applications of VLANs using the EDS-828.....	3-43
Configuring 802.1Q VLAN	3-44
Using Multicast Filtering.....	3-45
The Concept of Multicast Filtering	3-45
Configuring IGMP Snooping	3-48
Add Static Multicast MAC	3-50
Configuring GMRP	3-50
Multicast Filtering Behavior.....	3-51
Using Bandwidth Management.....	3-52
Configuring Bandwidth Management	3-52
Using Port Access Control	3-53
Configuring IEEE 802.1X	3-55
Configuring Static Port Lock.....	3-57
Using IP Filter	3-58
Using Auto Warning	3-58
Configuring Email Warning	3-58
Email Alarm Events Settings	3-59
Email Warning Event Settings	3-60
Configuring Relay Warning	3-61
Relay Alarm Event Settings	3-62
Relay Alarm List	3-63
Using Line-Swap-Fast-Recovery.....	3-63

Configuring Line-Swap Fast Recovery	3-63
Using Set Device IP.....	3-64
Configuring Set Device IP.....	3-65
Using Diagnosis	3-67
Mirror Port.....	3-67
Ping.....	3-68
LLDP Function Overview	3-68
Using Monitor	3-70
Monitor by Switch.....	3-70
Monitor by Port	3-70
Using the MAC Address Table	3-71
Using Layer 3 Settings	3-72
The Layer-3 Switching Concept	3-72
Interface Setting	3-73
Static Route.....	3-74
RIP Setting.....	3-74
OSPF Settings	3-75
OSPF Global Settings	3-76
OSPF Area Settings	3-76
OSPF Interface Settings	3-77
OSPF Virtual Link Settings	3-78
OSPF Area Aggregation Settings.....	3-79
OSPF Neighbor Table	3-79
OSPF Database Table.....	3-80
VRRP Settings.....	3-80
Routing Table	3-81
Using System Log.....	3-81
Event Log.....	3-81
Syslog Settings	3-82
Using HTTPS/SSL.....	3-83
4. EDS Configurator GUI	4-1
Starting EDS Configurator.....	4-2
Broadcast Search.....	4-2
Search by IP address	4-3
Upgrade Firmware	4-4
Modify IP Address	4-4
Export Configuration	4-5
Import Configuration.....	4-6
Unlock Server	4-7
A. MIB Groups	A-1
B. Modbus/TCP Map	B-1

Introduction

Welcome to the Moxa EtherDevice Switch EDS-828 Series, the modular managed Gigabit Ethernet Switch designed especially for connecting Ethernet-enabled devices in industrial field applications.

The following topics are covered in this chapter:

- ❑ **Overview**
- ❑ **Package Checklist**
- ❑ **Features**
- ❑ **Recommended Software and Accessories**

Overview

The EDS-828 is a high-performance Layer 3 Ethernet switch designed for network routing. The improved hardware technology built into the EDS-828 replaces the software logic used by traditional routers, offering better performance, and making the switch ideal for large scale local area networks (LANs). In addition to Layer 3 features, the EDS-828 also supports Layer 2 management features, including QoS, IGMP snooping/GMRP, VLAN, LACP, SNMPv1/v2c/v3, RMON, IEEE 802.1X, HTTPS, and SSH. In order to meet the demands of any industrial application, the EDS-828 uses a modular design that allows users to install up to 4 Gigabit Ethernet ports and 24 fast Ethernet ports, providing a high degree of flexibility for network expansion.

Package Checklist

Moxa's EDS-828 is shipped with the following items. If any of these items is missing or damaged, please contact your customer service representative for assistance.

- 1 Moxa EDS-828 modular switch system or Interface Module
- Hardware Installation Guide
- CD-ROM with User's Manual and Windows Utility (for EDS-828 modular switch system only)
- Moxa Product Warranty booklet
- RJ45 to DB9 Console port cable

NOTE: Please notify your Moxa sales representative if any of the above items is missing or damaged.

Features

- Gigabit Ethernet Turbo Ring, Turbo Chain (< 20ms recovery time at full load) and STP/RSTP (IEEE 802.1w/D)
- Static routing, RIP V1/V2, and OSPF to move data between networks
- VRRP ensures redundant routing paths
- IEEE 1588 PTP (Precision Time Protocol) for precise time synchronization of networks
- DHCP Option 82 for IP address assignment for different policies
- Supports Modbus TCP for easy integration in HMI
- Supports LLDP (Link Layer Discovery Protocol)
- Redundant Gigabit Turbo Ring, RSTP/STP (IEEE 802.1w/D), and Turbo Chain
- IGMP snooping and GMRP for filtering multicast traffic from industrial Ethernet protocols
- IEEE 802.1Q VLAN and GVRP protocol to ease network planning
- QoS-IEEE 802.1p/1Q and TOS/DiffServ to increase determinism
- Port Trunking for optimum bandwidth utilization
- IEEE 802.1X and https/SSL to enhance network security
- SNMP v1/v2c/v3 for different levels of network management
- RMON for efficient network monitoring and proactive capability
- Bandwidth management prevents unpredictable s
- Lock port function for blocking unauthorized access based on MAC address
- Port mirroring for online debugging
- Automatic warning by exception through e-mail, relay output
- Digital inputs for integrating sensors and alarms with IP networks
- Redundant, dual DC power inputs
- IP30, rugged high-strength case
- DIN-Rail or panel mounting capability
- Configurable by Web browser, Telnet/Serial console, Windows utility, and ABC-01 automatic backup configurator

Recommended Software and Accessories

- EDS-SNMP OPC Server Pro
- DR-45-24, DR-75-24, DR-120-24 DIN-Rail 24 VDC Power Supply Series
- WK-32: Wall Mounting Kit
- ABC-01 (Auto Backup Configurator): Industrial RS-232, RJ45-based, automatic backup configurator.
- RK-4U: 4U-high 19-inch rack mounting kit

Getting Started

This chapter explains how to access the EDS-828 for the first time. There are three ways to access the switch: serial console, Telnet console, and web browser. The serial console connection method, which requires using a short serial cable to connect the EDS-828 to a PC's COM port, can be used if you do not know the EDS-828's IP address. The Telnet console and web browser connection methods can be used to access the EDS-828 over an Ethernet LAN, or over the Internet.

The following topics are covered in this chapter:

- ❑ **RS-232 Console Configuration (115200, None, 8, 1, VT100)**
- ❑ **Configuration by Telnet Console**
- ❑ **Configuration by Web Browser**
- ❑ **Disabling Telnet and Browser Access**

RS-232 Console Configuration (115200, None, 8, 1, VT100)

NOTE
Connection Caution!

1. You cannot connect to the EDS-828 simultaneously by serial console and Telnet.
2. You can connect to the EDS-828 simultaneously by web browser and serial console, or by web browser and Telnet.
However, we strongly suggest that you do NOT use more than one connection method at the same time. Following this advice will allow you to maintain better control over the configuration of your EDS-828.

NOTE

We recommend using Moxa PComm Terminal Emulator, which can be downloaded free of charge from Moxa's website.

Before running PComm Terminal Emulator, use an RJ45 to DB9-F (or RJ45 to DB25-F) cable to connect the EDS-828's RS-232 Console port to your PC's COM port (generally COM1 or COM2, depending on how your system is set up).

After installing PComm Terminal Emulator, take the following steps to access the RS-232 Console utility.

1. From the Windows desktop, click on **Start → Programs → PCommLite1.3 → Terminal Emulator**.

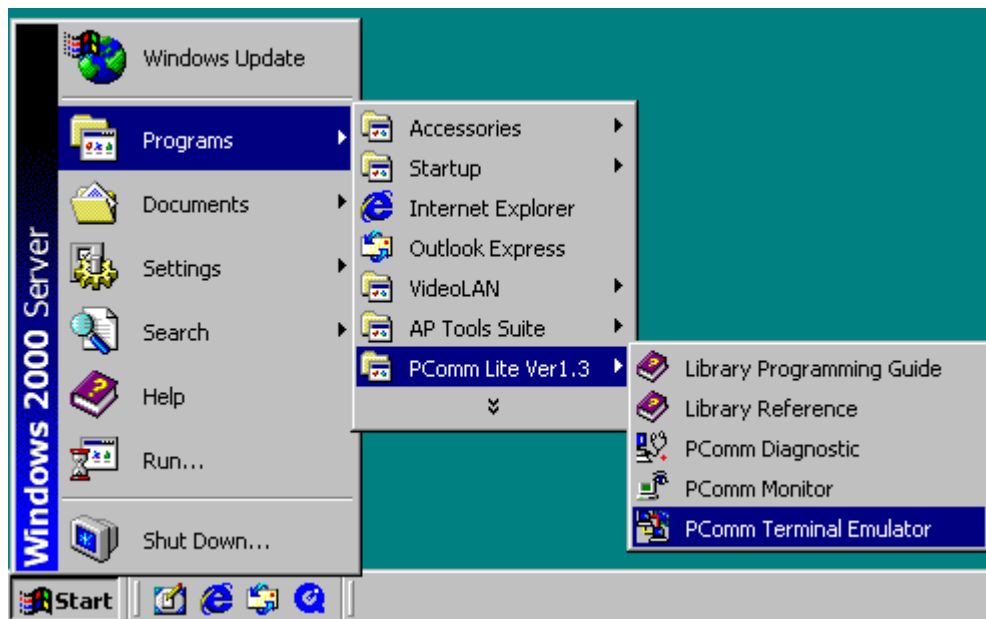

2. Select **Open** under **Port Manager** to open a new connection.

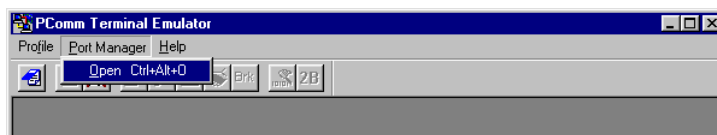

- The **Communication Parameter** page of the **Property** window opens. Select the appropriate COM port for **Console Connection**, **115200** for **Baud Rate**, **8** for **Data Bits**, **None** for **Parity**, and **1** for **Stop Bits**.

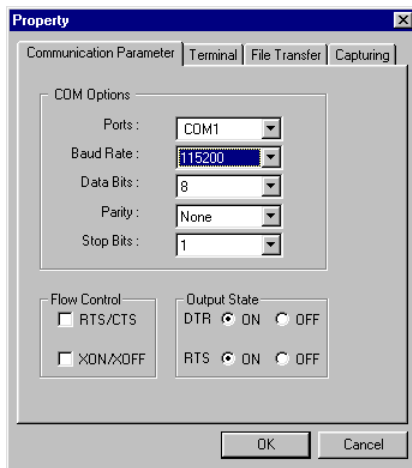

- Click on the **Terminal** tab, and select **VT100** for **Terminal Type**. Click on **OK** to continue.

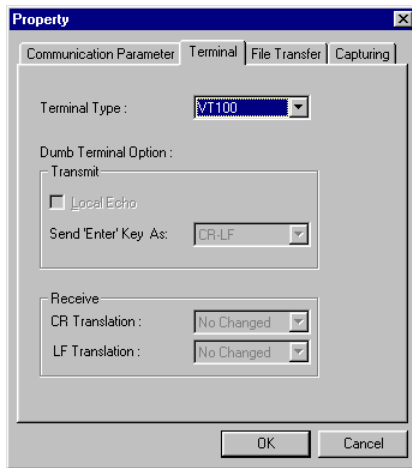

- Type **1** to select **ansi/VT100** terminal type, and then press **Enter**.

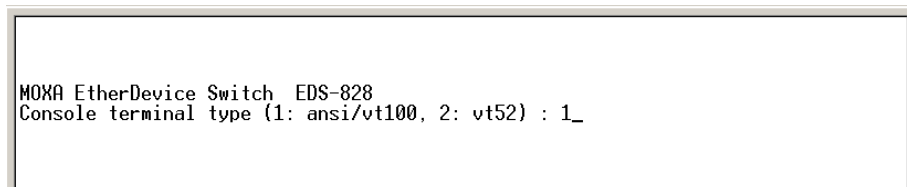

- The Console login screen will appear. Press **Enter** to open the Account pop-up selector and then select either **admin** or **user**. Use the keyboard's down arrow to move the cursor to the Password field, enter the **Console Password** (this is the same as the Web Browser password; leave the **Password** field blank if a console password has not been set), and then press **Enter**.

```

Model :          EDS-828
Name :          Managed Redundant Switch 00002
Location :      Switch Location

Firmware Version : V1.1
Serial No :     00002
IP :           192.168.127.251
MAC Address :   00-90-E8-04-05-06
    
```

```

+-----+
| Account : |admin|
| Password : |
+-----+
    
```

7. The EDS-828's **Main Menu** will be displayed. (NOTE: To modify the appearance of the PComm Terminal Emulator window, select **Font...** under the **Edit** menu, and then choose the desired formatting options.)

```

EDS-828 series V1.1
-----
1. Basic Settings          - Basic settings for network and system parameter.
2. Port Trunking          - Allows multiple ports to be aggregated as a link.
3. SNMP Settings         - The settings for SNMP.
4. Comm. Redundancy      - Establish Ethernet communication redundant path.
5. Traffic Prioritization- Prioritize Ethernet traffic to help determinism.
6. Virtual LAN           - Set up a VLAN by IEEE802.1Q VLAN.
7. Multicast Filtering   - Enable the multicast filtering capability.
8. Bandwidth Management - Restrict unpredictable network traffic.
9. Port Access Control   - Port access control by IEEE802.1X or Static Port Lock.
a. IP Filter             - The settings for IP Filter.
b. Auto Warning          - Warning email and/or relay output by events.
c. Line Swap             - Fast recovery after moving devices to different ports.
d. Set Device IP         - Assign IP addresses to connected devices.
e. Diagnosis             - Test network integrity and mirroring port.
f. Monitor               - Monitor a port and network status.
g. MAC Address Table     - The complete table of Ethernet MAC Address List.
h. Layer3 Settings       - Layer3 settings for interfaces and routing protocols.
i. System log            - The setting for System log, and Event log.
j. Exit                  - Exit
    - Use the up/down arrow keys to select a category,
    and then press Enter to select. -
    
```

8. After entering the **Main Menu**, use the following keys to move the cursor, and to select options.

Key	Function
Up/Down/Left/Right arrows, or Tab	Move the onscreen cursor
Enter	Display & select options
Space	Toggle options
Esc	Previous Menu

Configuration by Telnet Console

You may use Telnet to access the EDS-828's console utility over a network. To be able to access the EDS's functions over the network (by Telnet or Web Browser) from a PC host that is connected to the same LAN as the EDS-828, you need to make sure that the PC host and the EDS-828 are on the same logical subnetwork. To do this, check your PC host's IP address and subnet mask. By default, the EDS-828's IP address is 192.168.127.253 and the EDS-828's subnet mask is 255.255.255.0 (for a Class C network). If you do not change these values, and your PC host's subnet mask is 255.255.255.0, then its IP address must have the form 192.168.127.xxx. On the other hand, if your PC host's subnet mask is 255.255.255.0, then its IP address must have the form 192.168.127.xxx.

NOTE To use the EDS-828's management and monitoring functions from a PC host connected to the same LAN as the EDS-828, you must make sure that the PC host and the EDS-828 are on the same logical subnetwork.

NOTE Before accessing the console utility via Telnet, first connect one of the EDS-828's RJ45 Ethernet ports to your Ethernet LAN, or directly to your PC's Ethernet NIC. You can establish a connection with either a straight-through or cross-over Ethernet cable.

NOTE The EDS-828's default IP is 192.168.127.253.

Follow the steps below to access the console utility via Telnet.

1. Click on **Start → Run**, and then telnet to the EDS-828's IP address from the Windows **Run** window. (You may also issue the telnet command from the MS-DOS prompt.)

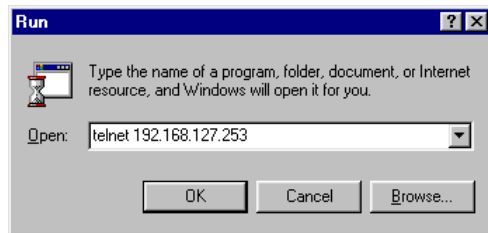

2. Type **1** to choose **ansi/vt100**, and then press **Enter**.

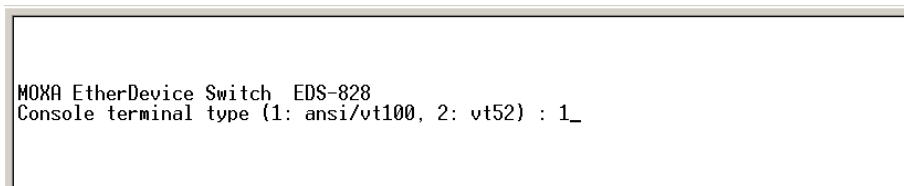

3. The Console login screen will appear. Press **Enter** to open the Account pop-up selector and then select either **admin** or **user**. Use the keyboard's down arrow to move the cursor to the Password field, enter the **Console Password** (this is the same as the Web Browser password; leave the **Password** field blank if a console password has not been set), and then press **Enter**.

NOTE The Telnet Console looks and operates in precisely the same manner as the RS-232 Console.

Configuration by Web Browser

The Moxa EDS-828's web browser interface provides a convenient way to modify the switch's configuration and access the built-in monitoring and network administration functions. The recommended web browser is Microsoft Internet Explorer with JVM (Java Virtual Machine) installed.

NOTE To use the EDS-828's management and monitoring functions from a PC host connected to the same LAN as the EDS-828, you must make sure that the PC host and the EDS-828 are on the same logical subnetwork.

NOTE If the EDS-828 is configured for other VLAN settings, you must make sure your PC host is on the management VLAN. Refer to the "Configuring 802.1Q VLAN" in Chapter 3 for the VLAN settings.

NOTE Before accessing the EDS-828's web browser interface, first connect one of its RJ45 Ethernet ports to your Ethernet LAN, or directly to your PC's Ethernet NIC. You can establish a connection with either a straight-through or cross-over Ethernet cable.

NOTE The EDS-828's default IP is 192.168.127.253.

Follow the steps below to access the EDS-828's web browser interface.

1. Open Internet Explorer and type the EDS-828's IP address in the **Address** field. Press **Enter** to establish the connection.

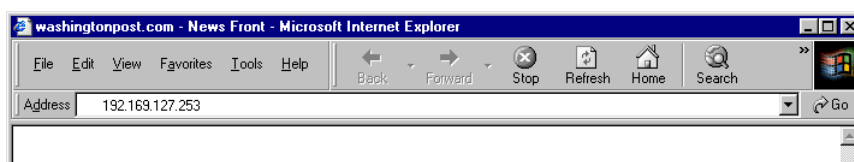

- The web login page will open. Select the login account (Admin or User) and enter the **Password** (this is the same as the Console password), and then click **Login** to continue. Leave the **Password** field blank if a password has not been set.

NOTE By default, the EDS-828's password is not set (i.e., is blank).

You may need to wait a few moments for the web page to be downloaded to your computer. Use the menu tree on the left side of the window to open the function pages to access each of the Moxa EtherDevice Switch's functions.

MOXA™ EtherDevice™ Switch EDS-828 Series

Model: EDS-828 IP: 192.168.127.253 MAC Address: 00-90-E8-34-23-12 STAT: PWR1 MASTER PWR2 COUPLER FAULT TRING
 Name: Managed Redundant Switch 00711 Serial No.: 00711 Firmware Version: V1.1
 Location: Switch Location

Welcome to the Web Console

See below for a brief description of each function groups, and then click on the item in the left pane to access the item.

- Basic Settings - Basic settings for network management parameters and system configurations.
- Port Trunking - Allows multiple-ports to be aggregated as a link.
- SNMP - The settings for SNMP.
- Communication Redundancy - Establish Ethernet communication redundant path.
- Traffic Prioritization - Prioritize Ethernet traffic to increase determinism.
- Virtual LAN - Set up a VLAN by IEEE 802.1Q VLAN.
- Multicast Filtering - Enable the multicast filtering capability.
- Bandwidth Management - Restrict unpredictable network traffic.
- Port Access Control - Port-based access control by IEEE 802.1X or Static Port Lock.
- IP Filter - The settings for IP Filter.
- Auto Warning - Automatically send warning email and/or trigger relay output by event.
- Line-Swap Fast Recovery - Fast recovery after moving devices to different ports.
- Set Device IP - Assign IP addresses to connected devices.
- Diagnosis - Use Ping command to test network integrity and mirroring port for online data monitoring.
- Monitor - Monitor port and network status.
- MAC Address Table - The complete list of Ethernet MAC Addresses.
- L3 Setting - Layer3 settings for interfaces and routing protocols.
- Event Log Table - The complete list of alarm events.
- Syslog - Send event notification messages to syslog server.

Disabling Telnet and Browser Access

If you are connecting the EDS-828 to a public network, but do not intend to use its management functions over the network, then we suggest disabling both **Telnet Console** and **Web Configuration** from the RS-232 Console's **Basic Settings** → **System Identification** page, as shown in the following figure.

```

c:\ Telnet 192.168.127.253
MOXA EtherDevice Switch EDS-828
Basic Settings
[System] [Password] [Accessible IP] [Port] [Network] [Time] [Backup Media]
[Restart] [Factory default] [Activate] [Main menu]
System Identification
ESC: Previous menu  Enter: Select  Space bar: Toggle

Switch Name          [Managed Redundant Switch 28268]
Switch Location      [Switch Location]

Switch Description    [ ]
Maintainer Contact Info [ ]

Serial NO.           2826803
Firmware Version     V1.0
MAC Address           00-90-E8-34-23-12

Telnet Console       [Enable ]
Web Configuration    [http or https]
  
```

Featured Functions

This chapter explains how to access the EDS-828's various configuration, monitoring, and administration functions. There are three ways to access these functions: RS-232 console, Telnet console, and web browser. The serial console connection method, which requires using a short serial cable to connect the EDS-828 to a PC's COM port, can be used if you do not know IP address for the EDS-828. The Telnet console and web browser connection methods can be used to access the EDS-828 over an Ethernet LAN, or over the Internet.

The Web Console is the most user-friendly way to configure the EDS-828. In this chapter, we use the Web Console interface to introduce the functions. There are only a few differences between the Web Console, Serial Console, and Telnet Console.

The following topics are covered in this chapter:

- ❑ **Overview**
- ❑ **Configuring Basic Settings**
- ❑ **Using Port Trunking**
- ❑ **Configuring SNMP**
- ❑ **Using Communication Redundancy**
- ❑ **Using Traffic Prioritization**
- ❑ **Using Virtual LAN**
- ❑ **Using Multicast Filtering**
- ❑ **Using Bandwidth Management**
- ❑ **Using Port Access Control**
- ❑ **Using IP Filter**
- ❑ **Using Auto Warning**
- ❑ **Using Line-Swap-Fast-Recovery**
- ❑ **Using Set Device IP**
- ❑ **Using Diagnosis**
- ❑ **Using Monitor**
- ❑ **Using the MAC Address Table**
- ❑ **Using Layer 3 Settings**
- ❑ **OSPF Settings**
- ❑ **Using System Log**
- ❑ **Using HTTPS/SSL**

Overview

A brief description of each function group of your EDS-828 is shown on the **Overview** web page.

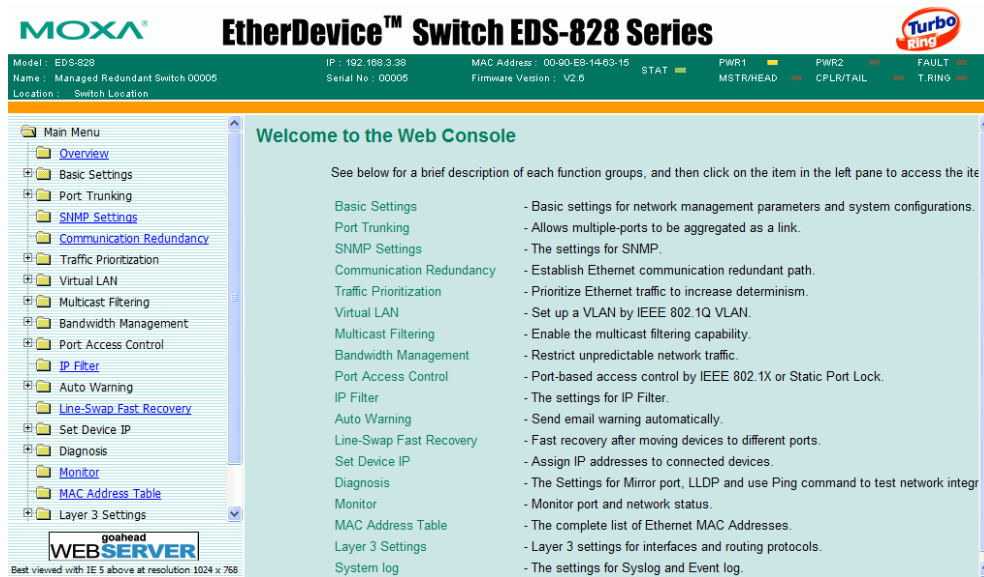

Configuring Basic Settings

The Basic Settings group includes the most commonly used settings required by administrators to maintain and control the EDS-828.

System Identification

The system identification items are displayed at the top of the web page, and will be included in alarm emails. Setting system identification items makes it easier to identify the different switches connected to your network.

System Identification

Switch Name	<input type="text" value="Managed Redundant Switch 00005"/>
Switch Location	<input type="text" value="Switch Location"/>
Switch Description	<input type="text" value="MOXA EDS-828"/>
Maintainer Contact Info	<input type="text"/>
Web Configuration	<input style="border: none; border-bottom: 1px solid #ccc;" type="text" value="http or https"/> ▼
Web Auto-logout (s)	<input type="text" value="0"/>
Age Time (s)	<input type="text" value="300"/>
<input type="button" value="Activate"/>	

Switch Name

Setting	Description	Factory Default
Max. 30 Characters	This option is useful for specifying the role or application of different EDS-828 units. E.g., Factory Switch 1.	Industrial Redundant Switch [Serial No. of this switch]

Switch Location

Setting	Description	Factory Default
Max. 80 Characters	To specify the location of different EDS-828 units. E.g., production line 1.	Switch Location

Switch Description

Setting	Description	Factory Default
Max. 30 Characters	Use this space to record a more a detailed description of the EDS-828 unit.	None

Maintainer Contact Info

Setting	Description	Factory Default
Max. 30 Characters	To provide information about whom to contact in order to resolve problems. Use this space to record contact information of the person responsible for maintaining this EDS-828.	None

Web Configuration

Setting	Description	Factory Default
Disable	Both https and https web consoles are disabled	http or https
http or https	Both https and https web consoles are enabled	
https only	Only https console is enabled	

Web Auto-logout (s)

Setting	Description	Factory Default
0	Disable web console auto-logout function	0
60 to 86400	Web console will auto log out in the specified time	

Age Time (s)

Setting	Description	Factory Default
15 to 3825	Time for MAC address to flush out	0

The **Age Time** is the number of seconds a MAC address will be kept in the forwarding database after it receives a packet from this MAC address. The entries in the forwarding database are periodically timed out to ensure they won't stay around forever. This number is changeable for your application. Setting the Age Time to zero makes all entries permanent.

Password

The EDS-828 provides two levels of access privilege: **admin** privilege gives read/write access of all EDS-828 configuration parameters, and **user** privilege provides read access only. You will be able to view the configuration, but will not be able to make modifications.

Account :

Password :



ATTENTION

The EDS-828's default Password is not set (i.e., is blank). If a Password is already set, then you will be required to type the Password when logging into either the RS-232 Console, Telnet Console, or Web Browser interface.

Account

Setting	Description	Factory Default
admin	"admin" privilege allows the user to modify all EDS-828 configurations.	admin
user	"user" privilege only allows viewing the EDS-828 configurations.	

Password

Setting	Description	Factory Default
Old Password (Max. 16 Characters)	Type current password when changing the password	None
New Password (Max. 16 Characters)	Type new password when changing the password	None
Retype Password (Max. 16 Characters)	If you type a new password in the Password field, you will be required to retype the password in the Retype new password field before updating the new password.	None

Password Setting

Account Name :

Old Password :

Type Old Password :

New Password :

Retype Password :

Accessible IP

The EDS-828 uses an IP address-based filtering method to control access to EDS-828 units.

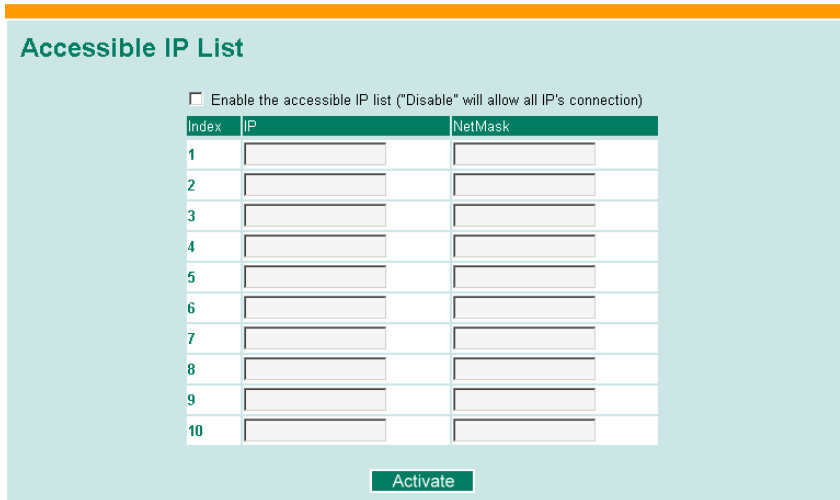

Accessible IP Settings allows you to add or remove “Legal” remote host IP addresses to prevent unauthorized access. Access to the EDS-828 is controlled by IP address. That is, if a host’s IP address is in the accessible IP table, then the host will be allowed access to the EDS-828. You can allow one of the following cases by setting this parameter:

- **Only one host with the specified IP address can access the EDS-828**
E.g., enter “192.168.1.1/255.255.255.255” to allow access to just the IP address 192.168.1.1.
- **Any host on a specific subnetwork can access the EDS-828**
E.g., enter “192.168.1.0/255.255.255.0” to allow access to all IPs on the subnetwork defined by this IP address/subnet mask combination.
- **Any host can access the EDS-828**
Disable this function by not checkmarking the “Enable the accessible IP list” checkbox.

The following table shows additional configuration examples:

Allowable Hosts	Input format
Any host	Disable
192.168.1.120	192.168.1.120 / 255.255.255.255
192.168.1.1 to 192.168.1.254	192.168.1.0 / 255.255.255.0
192.168.0.1 to 192.168.255.254	192.168.0.0 / 255.255.0.0
192.168.1.1 to 192.168.1.126	192.168.1.0 / 255.255.255.128
192.168.1.129 to 192.168.1.254	192.168.1.128 / 255.255.255.128

Port

Port settings are included to give the user control over Port Access, Port Transmission Speed, Flow Control, and Port Type (MDI or MDIX). An explanation of each configuration item is given below.

Port	Enable	Description	Name	Speed	FDX Flow Ctrl	MDI/MDIX
2-1	<input checked="" type="checkbox"/>	100BaseTX_RJ45.		Auto	Disable	Auto
2-2	<input checked="" type="checkbox"/>	100BaseTX_RJ45.		Auto	Disable	Auto
2-3	<input checked="" type="checkbox"/>	100BaseTX_RJ45.		Auto	Disable	Auto
2-4	<input checked="" type="checkbox"/>	100BaseTX_RJ45.		Auto	Disable	Auto

Activate

Enable

Setting	Description	Factory Default
checked	Allows data transmission through the port.	enabled
unchecked	Immediately shuts off port access.	

Description

Setting	Description	Factory Default
Media type	Displays the media type for each module's port	N/A

Name

Setting	Description	Factory Default
Max. 63 Characters	Specify an alias for each port, and assist the administrator in remembering important information about the port. E.g., PLC 1	None

Port Transmission Speed

Setting	Description	Factory Default
Auto	Allows the port to use the IEEE 802.3u protocol to negotiate with connected devices. The port and connected devices will determine the best speed for that connection.	Auto-nego
100M-Full	Choose one of these fixed speed options if the opposing Ethernet device has trouble auto-negotiating for line speed.	
100M-Half		
10M-Full		
10M-Half		

FDX Flow Control

Setting	Description	Factory Default
Enable	Enables flow control for this port when in auto-nego mode.	Disable
Disable	Disables flow control for this port when in auto-nego mode.	

This "FDX Flow Control" setting enables or disables the flow control capability of this port when the "port transmission speed" setting is in "auto" mode. The final result will be determined by the "auto" process between the EDS-828 and connected devices.

MDI/MDIX

Setting	Description	Factory Default
Auto	Allows the port to auto detect the port type of the opposing Ethernet device and change the port type accordingly.	Auto
MDI	Choose the MDI or MDIX option if the opposing Ethernet device has trouble auto-negotiating for port type.	
MDIX		

Network

The **Network** configuration allows users to modify the usual TCP/IP network parameters. An explanation of each configuration item is given below.

Auto IP Configuration

Setting	Description	Factory Default
Disable	Set up the EDS-828's IP address manually.	Disable
By DHCP	The EDS-828's IP address will be assigned automatically by the network's DHCP server.	
By BootP	The EDS-828's IP address will be assigned automatically by the network's BootP server.	

Switch IP Address

Setting	Description	Factory Default
IP Address of the EDS-828	Identifies the EDS-828 on a TCP/IP network.	192.168.127.253

Switch Subnet Mask

Setting	Description	Factory Default
Subnet mask of the EDS-828	Identifies the type of network to which the EDS-828 is connected (e.g., 255.255.0.0 for a Class B network, or 255.255.255.0 for a Class C network).	255.255.255.0

Default Gateway

Setting	Description	Factory Default
Default Gateway of the EDS-828	The IP address of the router that connects the LAN to an outside network.	None

DNS IP Address

Setting	Description	Factory Default
1st DNS Server's IP Address	The IP address of the DNS Server used by your network. After entering the DNS Server's IP address, you can input the EDS-828's url (e.g., www.eds.company.com) in your browser's address field, instead of entering the IP address.	None
2nd DNS Server's IP Address	The IP address of the DNS Server used by your network. The EDS-828 will try to locate the 2nd DNS Server if the 1st DNS Server fails to connect.	None

Time

The EDS-828 has a time calibration function based on information from an NTP server or user specified Time and Date information. Functions such as Auto warning “Email” can add real-time information to the message.

NOTE The EDS-828 does not have a real time clock. The user must update the Current Time and Current Date to set the initial time for the EDS-828 after each reboot, especially when the network doesn’t have an Internet connection for NTP server or there is no NTP server on the LAN.

Current Time

Setting	Description	Factory Default
User adjustable time.	The time parameter allows configuration of the local time in local 24-hour format.	None (hh:mm:ss)

Current Date

Setting	Description	Factory Default
User adjustable date.	The date parameter allows configuration of the local date in yyyy-mm-dd format.	None (yyyy/mm/dd)

Daylight Saving Time

Daylight saving time (also know as **DST** or **summer time**) involves advancing clocks (usually 1 hour) during the summer time to provide an extra hour of daylight in the afternoon.

Start Date

Setting	Description	Factory Default
User adjustable date.	The Start Date parameter allows users to enter the date that daylight saving time begins.	None

End Date

Setting	Description	Factory Default
User adjustable date.	The End Date parameter allows users to enter the date that daylight saving time ends.	None

Offset

Setting	Description	Factory Default
User adjustable date.	The offset parameter indicates how many hours forward the clock should be advanced.	None

System Up Time

Indicates the EDS-828's up time from the last cold start. The unit is seconds.

Time Zone

Setting	Description	Factory Default
User selectable time zone	The time zone setting allows conversion from GMT (Greenwich Mean Time) to local time.	GMT (Greenwich Mean Time)

NOTE Changing the time zone will automatically correct the current time. You should configure the time zone before setting the time.

Time Server IP/Name

Setting	Description	Factory Default
1st Time Server IP/Name	IP or Domain address (e.g., 192.168.1.1 or time.stdtime.gov.tw or time.nist.gov).	None
2nd Time Server IP/Name	The EDS-828 will try to locate the 2nd NTP Server if the 1st NTP Server fails to connect.	

Time Server Query Period

Setting	Description	Factory Default
Query Period	This parameter determines how frequently the time is updated from the NTP server.	600 seconds

IEEE 1588 PTP

The following information is taken from the NIST website at <http://ieee1588.nist.gov/intro.htm>:

Time measurement can be accomplished using the IEEE Standard for a Precision Clock Synchronization Protocol for Networked Measurement and Control Systems (IEEE 1588-2008) to synchronize real-time clocks incorporated within each component of the electrical power system for power automation applications.

IEEE 1588, which was published in November 2002, expands the performance capabilities of Ethernet networks to control systems that operate over a communication network. In recent years an increasing number of electrical power systems have been using a more distributed architecture with network technologies that have less stringent timing specifications. IEEE 1588 generates a master-slave relationship between the clocks, and enforces the specific timing requirements in such power systems. All devices ultimately get their time from a clock known as the grandmaster clock. In its basic form, the protocol is intended to be administration free.

How Does an Ethernet Switch Affect 1588 Synchronization?

The following content is taken from the NIST website at <http://ieee1588.nist.gov/switch.htm>:

An Ethernet switch potentially introduces multi-microsecond fluctuations in the latency between the 1588 grandmaster clock and a 1588 slave clock. Uncorrected these fluctuations will cause synchronization errors. The magnitude of these fluctuations depend on the design of the Ethernet switch and the details of the communication traffic. Experiments with prototype implementations of IEEE 1588 indicate that with suitable care the effect of these fluctuations can be successfully managed. For example, use of appropriate statistics in the 1588 devices to recognized significant fluctuations and use suitable averaging techniques in the algorithms controlling the correction of the local 1588 clock will be the good design means to achieve the highest time accuracy.

Can Ethernet switches be designed to avoid the effects of these fluctuations?

A switch may be designed to support IEEE 1588 to avoid the effects of queuing. In this case two modifications to the usual design of an Ethernet switch are necessary:

- The **Boundary Clock** functionality defined by IEEE 1588 must be implemented in the switch, and
- The switch must be configured such that it does not pass IEEE 1588 message traffic using the normal communication mechanisms of the switch.

Such an Ethernet switch will synchronize clocks directly connected to one of its ports to the highest possible accuracy.

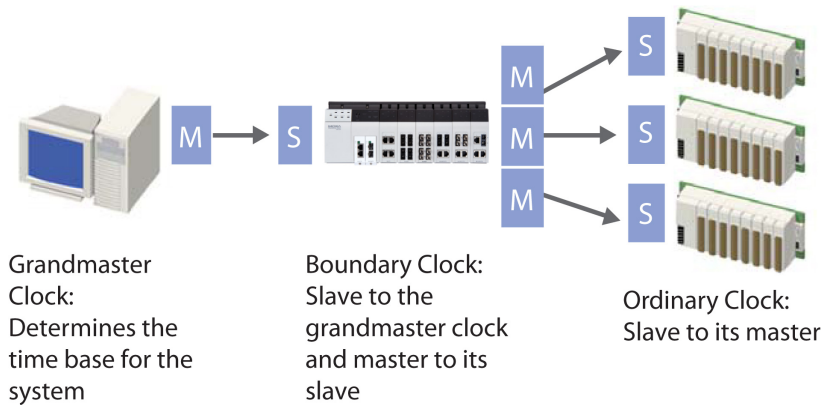

PTP Setting

PTP Setting

Operation IEEE 1588/PTP
 Operation Enable PTP

Configuration IEEE 1588/PTP
 Clock Mode: Software v1 BC mode
 Sync Interval: 1
 Subdomain Name: _DFLT

Status
 Offset To Master(nsec)
 Grandmaster UUID
 Parent UUID
 Clock Stratum
 Clock Identifier

PTP Port Settings

Port	Port Enable	Port Status
1-1	<input type="checkbox"/> Enable	PTP_DISABLED
1-2	<input type="checkbox"/> Enable	PTP_DISABLED
1-3	<input type="checkbox"/> Enable	PTP_DISABLED
1-4	<input type="checkbox"/> Enable	PTP_DISABLED
2-1	<input type="checkbox"/> Enable	PTP_DISABLED

Activate

Operation IEEE 1588/PTP

Setting	Description	Factory Default
Operation	Disable or enable IEEE 1588(PTP) operation	Disable

Configuration IEEE 1588/PTP

Setting	Description	Factory Default
Clock Mode	Support software-based IEEE 1588(PTP) mode	Disable
Sync Interval	Period for sending synchronization message (in seconds)	Disable
Sub-domain Name	Support _DFLT(Default) domain only	_DFLT

Status

Setting	Description	Factory Default
Offset To Master (nsec)	Deviation between local time and the reference clock (in nanoseconds).	
Grandmaster UUID	When the clock has a port in PTP_SLAVE state, this member's value is the value of the grand master clock's Uuid field of the last Sync message received from the parent of the slave port.	
Parent UUID	When the clock has a port in PTP_SLAVE state, this member's value is the value of the source-Uuid field of the last Sync message received from the parent of the slave port.	
Clock Stratum	The stratum number describes one measure of the quality of a clock. Each clock is characterized by a stratum number used by the best master clock algorithm as one parameter of clock quality.	4
Clock Identifier	Properties of the clock.	DFLT

PTP Port Settings

Setting	Description	Factory Default
Port Enable	Enable or disable PTP port operation.	None
Port Status	Display PTP port real status.	PTP_DISABLED

System File Update—By Remote TFTP

The EDS-828 supports saving your configuration file to a remote TFTP server or local host to allow other EDS-828 switches to use the same configuration at a later time, or saving the Log file for future reference. Loading pre-saved firmware or a configuration file from the TFTP server or local host is also supported for easy upgrading or configuration of the EDS-828.

TFTP Server IP/Name

Setting	Description	Factory Default
IP Address of TFTP Server	The IP or name of the remote TFTP server. Must be set up before downloading or uploading files.	None

Configuration file path and name

Setting	Description	Factory Default
Max. 40 Characters	The path and file name of the EDS-828's configuration file in the TFTP server.	None

Firmware file path and name

Setting	Description	Factory Default
Max. 40 Characters	The path and file name of the EDS-828's firmware file.	None

Log file path and name

Setting	Description	Factory Default
Max. 40 Characters	The path and file name of the EDS-828's log file	None

After setting up the desired path and file name, click on **Activate** to save the setting, and then click on **Download** to download the prepared file from the remote TFTP server, or click on **Upload** to upload the desired file to the remote TFTP server.

System File Update—By Local Import/Export

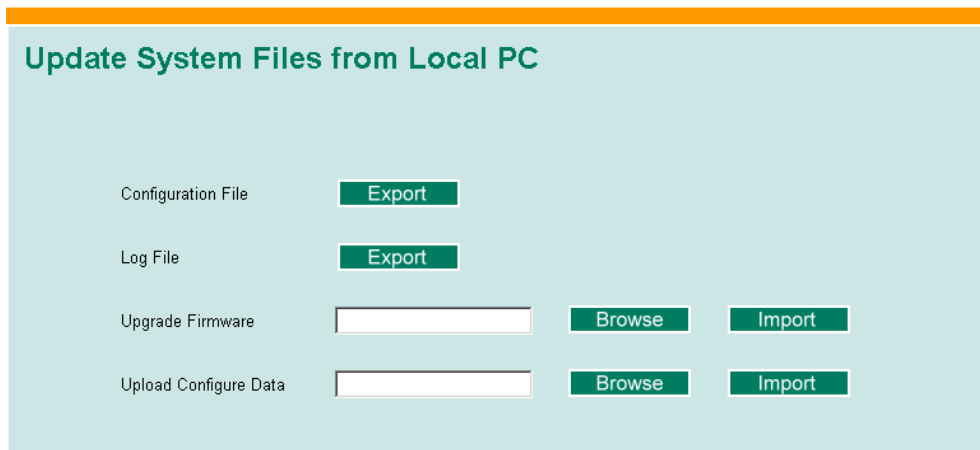

Configuration File

To export the configuration file of this EDS-828, click on **Export** to save it to the local host.

Log File

To export the Log file of this EDS-828, click on **Export** and save it to the local host.

NOTE Some operating systems will open the configuration file and log file directly in the web page. In such cases, right click on the "Export" button to save a file.

Upgrade Firmware

To import the firmware file of this EDS-828, click on **Browse** to select the firmware file already saved on your computer. The upgrade procedure will proceed automatically after clicking on **Import**.

Upload Configure Data

To import the configuration file of this EDS-828, click on **Browse** to select the configuration file already saved on your computer. The upgrade procedure will proceed automatically after clicking on **Import**.

System File Update—By Backup Media

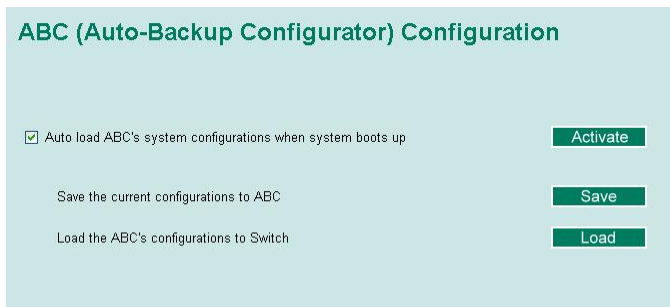

Auto load system configurations when system boots up

Setting	Description	Factory Default
Enable	Enables Auto load system configurations when system boots up	Enable
Disable	Disables Auto load system configurations when system boots up	

Save the current configurations to ABC

To export the current configuration file of the EDS-828, click on **Save** to save it to the ABC.

Load the ABC's configurations to the Switch

To import the configuration file of the EDS-828, click on **Load** to load it to the Switch

Restart



This function is used to restart the Moxa EtherDevice Switch

Factory Default

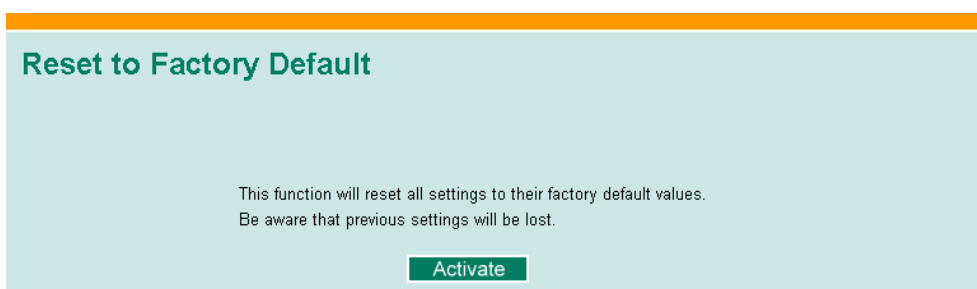

The Factory Default function is included to give users a quick way of restoring the EDS-828's configuration settings to their factory default values. This function is available in the Console utility (serial or Telnet) and Web Browser interface.

NOTE After activating the Factory Default function, you will need to use the default network settings to re-establish a web-browser or Telnet connection with your EDS-828.

Using Port Trunking

Link Aggregation allows one or more links to be aggregated together to form a Link Aggregation Group. A MAC client can treat Link Aggregation Groups as if they were a single link.

The EDS-828's Port Trunking feature allows devices to communicate by aggregating up to four links in parallel, with a maximum of eight ports for each link. If one of the eight ports fails, the other seven ports will provide back up and share the traffic automatically.

Port trunking can be used to combine up to eight ports between two EDS-828 switches. If all ports on both switch units are configured as 100BASE-TX and they are operating in full duplex, the potential bandwidth of the connection will be 1600 Mbps.

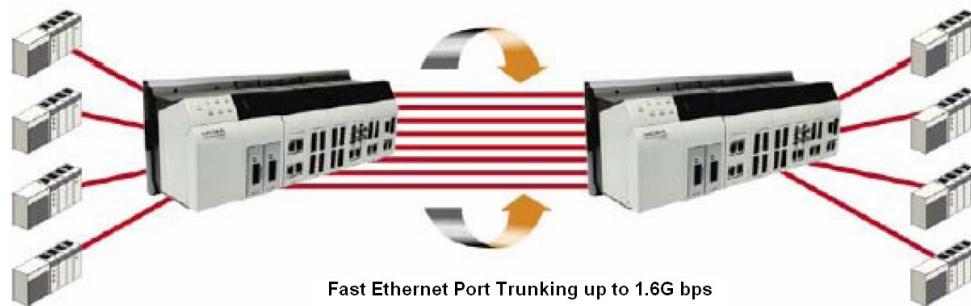

The Port Trunking Concept

The EDS-828 allows a maximum of 4 trunk groups, with a maximum of 8 trunk ports for each trunk group. You can configure the trunk group to be "Static" or "LACP." Once the trunk group is set to "LACP," all of the ports making up that group will be set to LACP enabled. The ports in the "Static" trunk groups, and all the non-trunk ports that do not belong to any trunk group, will be set to LACP disabled. When the port is set to LACP enabled, it will exchange LACP PDU with its link partner, and will result in "Forwarding." If all of the ports in the same group are "Blocked" or "Disabled" or "Down" (link-down), the trunk group will not work, and the user will see "LACP Failed" for that trunk group in the user interface.

Port Trunking applies to connections between backbone devices as well as to connections in other network areas where traffic bottlenecks exist. Port Trunking provides the following benefits:

- Gives you more flexibility in setting up your network connections, since the bandwidth of a link can be expanded to 8 times the original bandwidth.
- Load sharing—MAC Client traffic may be distributed across multiple links.

Keep the following points in mind when configuring port trunking:

- **To avoid broadcast storms or loops** in your network while configuring a trunk, first disable or disconnect all ports that you want to add to the trunk or remove from the trunk. After you finish configuring the trunk, enable or re-connect the ports.
- **Up to 4 port trunking groups** (designated Trk1, Trk2, Trk3, Trk4) can be used for each EDS-828.
- **Up to 8 ports** can be inserted into each port trunk group. The EDS-828 allows a maximum of 4 "Standby" ports for each LACP trunk group. In another words, a maximum of 12 ports can belong to each LACP trunk group.
- **The same transmission speed** must be assigned to all ports belonging to one port trunking group. E.g., 100M Full, 100M Half, 10M Full, or 10M Half. The auto-negotiation function should be disabled for these ports.
- **Full duplex operation only**—Link Aggregation is supported only on point-to-point links with MACs operating in full duplex mode.
- **Multipoint Aggregations**—The mechanisms specified in this clause do not support aggregations among more than two systems.

When you activate port trunking settings, some advanced functions will either be set to factory default values, or disabled:

- **Port stat**, such as transmitting speed, duplex, and flow control will be set to the factory defaults.
- **Communication Redundancy** will be set to the factory default.
- **802.1Q VLAN** will be set to the factory default and will be disabled.
- **Multicast Filtering** will be set to the factory default.
- **Port Lock** will be set to the factory default and will be disabled.
- **Set Device IP** will be set to the factory default
- **Mirror Port** will be set to the factory default and will be disabled.

Configuring Port Trunking

The **Port Trunking Settings** page is used to assign ports to a Trunk Group.

Step 1: Select Trk1, Trk2, Trk3, or Trk 4 from the **Trunk Group** drop-down box.

Step 2: Select Static or LACP from the **Trunk Type** drop-down box.

Step 3: Under **Member Ports** and **Available Ports**, checkmark to select specific ports.

Step 4: Use the **Up / Down** buttons to add/remove designated ports to/from a trunk group.

Trunk Group (Maximum of 4 trunk groups)

Setting	Description	Factory Default
Trk1, Trk2, Trk3, Trk4	Display or designate the Trunk Type and Member Ports for Trunk Group 1, 2, 3, or 4.	Trk1

Trunk Type

Setting	Description	Factory Default
Static	Designated Moxa proprietary trunking protocol	Static
LACP	Designated LACP (IEEE 802.3ad, Link Aggregation Control Protocol)	Static

Member Ports/Available Ports

Setting	Description	Factory Default
Member/Available Ports	Use Up/Down buttons to add/remove specific ports from available ports to/from trunk group.	N/A
Check box	Check to designate which ports to add or remove.	Unchecked
Port	Port number	N/A

Setting	Description	Factory Default
Port description	Displays the media type for each module's port	N/A
Name	Max. 63 Characters	N/A
Speed	Indicates the transmission speed (100M-Full, 100M-Half, 10M-Full, or 10M-Half)	N/A
FDX Flow Control	Indicates if the FDX flow control of this port is "Enabled" or "Disabled."	N/A
Up	Add designated ports into trunk group from available ports.	N/A
Down	Remove designated ports from trunk group to available port.	N/A

Trunk Table

Trunk Group	Member Port	Status
Trk1 (Static)	2-1	Success
	2-2	Success
	2-3	Success
	2-4	Success
Trk2 (LACP)	3-1	Success
	3-2	Success

Trunk Table

Setting	Description
Trunk Group	Displays the Trunk Type and Trunk Group.
Member Port	Display which member ports belong to the trunk group.
Status	Success means port trunking is working properly. Fail means port trunking is not working properly.

Configuring SNMP

The EDS-828 supports SNMP V1/V2c/V3. SNMP V1 and SNMP V2c use a community string match for authentication, which means that SNMP servers access all objects with read-only or read/write permissions using the community string *public/private* (default value). SNMP V3, which requires you to select an authentication level of MD5 or SHA, is the most secure protocol. You can also enable data encryption to enhance data security.

SNMP security modes and security levels supported by the EDS-828 are shown in the following table. Select the security mode and level that will be used to communicate between the SNMP agent and manager.

Protocol Version	UI Setting	Authentication Type	Data Encryption	Method
SNMP V1, V2c	V1, V2c Read Community	Community string	No	Use a community string match for authentication
	V1, V2c Write/Read Community	Community string	No	Use a community string match for authentication
SNMP V3	No-Auth	No	No	Use account with admin or user to access objects
	MD5 or SHA	Authentication based on MD5 or SHA	No	Provides authentication based on HMAC-MD5, or HMAC-SHA algorithms. 8-character passwords are the minimum requirement for authentication.
	MD5 or SHA	Authentication based on MD5 or SHA	Data encryption key	Provides authentication based on HMAC-MD5 or HMAC-SHA algorithms, and data encryption key. 8-character passwords and a data encryption key are the minimum requirements for authentication and encryption.

These parameters are configured on the SNMP page. A more detailed explanation of each parameter is given below the figure.

The screenshot shows the SNMP configuration interface with the following sections:

- SNMP Read/Write Settings:**
 - SNMP Versions: V1, V2c (dropdown)
 - V1, V2c Read Community: public
 - V1, V2c Write/Read Community: private
 - Admin Auth. Type: No-Auth (dropdown)
 - Admin Data Encryption Key: [text field]
 - User Auth. Type: No-Auth (dropdown)
 - User Data Encryption Key: [text field]
- Trap Settings:**
 - 1st Trap Server IP/Name: [text field]
 - 1st Trap Community: public
 - 2nd Trap Server IP/Name: [text field]
 - 2nd Trap Community: public
- Trap Mode:**
 - Trap Mode: Trap (dropdown)
 - Retries (1~99): 1
 - Timeout (1~300s): 1
- Private MIB information:**
 - Switch Object ID: enterprise.8691.7.14
 - Activate button

SNMP Read/Write Settings

SNMP Versions

Setting	Description	Factory Default
V1, V2c, V3, or V1, V2c, or V3 only	Select the SNMP protocol version used to manage the switch.	V1, V2c

V1, V2c Read Community

Setting	Description	Factory Default
V1, V2c Read Community	Use a community string match with a maximum of 30 characters for authentication. This means that the SNMP agent accesses all objects with read-only permissions using the community string public.	public

V1, V2c Write/Read Community

Setting	Description	Factory Default
V1, V2c Read/Write Community	Uses a community string match with a maximum of 30 characters for authentication. This means that SNMP servers access all objects with read/write permissions using the community string private.	private

For SNMP V3, there are two levels of privilege for different accounts to access the EDS-828. **Admin** privilege allows access, and authorization to read and write the MIB file. **User** privilege only allows reading the MIB file, but not authorization to write.

Admin Auth. Type (for SNMP V1, V2c, V3, and V3 only)

Setting	Description	Factory Default
No-Auth	Use admin. account to access objects. No authentication	No
MD5-Auth	Provide authentication based on the HMAC-MD5 algorithms. 8-character passwords are the minimum requirement for authentication.	No
SHA-Auth	Provide authentication based on the HMAC-SHA algorithms. 8-character passwords are the minimum requirement for authentication.	No

Admin Data Encryption Key (for SNMP V1, V2c, V3, and V3 only)

Setting	Description	Factory Default
Enable	8-character data encryption key is the minimum requirement for data encryption (maximum of 30 characters)	No
Disable	No data encryption	No

User Auth. Type (for SNMP V1, V2c, V3 and V3 only)

Setting	Description	Factory Default
No-Auth	Use admin account or user account to access objects. No authentication.	No
MD5-Auth	Provides authentication based on the HMAC-MD5 algorithms. 8-character passwords are the minimum requirement for authentication.	No
SHA-Auth	Provides authentication based on the HMAC-SHA algorithms. 8-character passwords are the minimum requirement for authentication.	No

User Data Encryption Key (for SNMP V1, V2c, V3 and V3 only)

Setting	Description	Factory Default
Enable	8-character data encryption key is the minimum requirement for data encryption (maximum of 30 characters)	No
Disable	No data encryption	No

Trap Settings

SNMP Trap Mode

In Trap mode, the SNMP agent sends a SNMPv1 trap PDU to the NMS. No acknowledgment is sent back from the NMS so the agent has no way of knowing if the trap reached the NMS.

Trap Mode

Trap

Retries (1~99)

Timeout (1~300s)

SNMP Inform Mode

SNMPv2 provides an inform mechanism. When an inform message is sent from the SNMP agent to the NMS, the receiver sends a response to the sender acknowledging receipt of the event. This behavior is similar to that of the get and set request. If the SNMP agent doesn't receive a response from the NMS for a period of time, the agent will resend the trap to the NMS agent. The maximum timeout time is 300 seconds (default is 1 second), and the maximum number of retries is 99 times (default is 1 time). When the SNMP agent receives acknowledgement from the NMS, it will stop resending the inform messages.

Trap Server IP/Name

Setting	Description	Factory Default
IP or Name	Enter the IP address or name of the Trap Server used by your network.	None

Trap Community

Setting	Description	Factory Default
character string	Use a community string match for authentication (maximum of 30 characters).	public

Inform Mode Select

Setting	Description	Factory Default
Retries	Enter Inform Retry number	1
Time out	Enter Inform Timeout window	1

Private MIB information

Switch Object ID

Setting	Description	Factory Default
8691.7.14	The EDS-828's enterprise value	Fixed

NOTE: *The Switch Object ID cannot be changed.*

Using Communication Redundancy

Setting up Communication Redundancy on your network helps protect critical links against failure, protects against network loops, and keeps network downtime at a minimum.

The Communication Redundancy function allows the user to set up redundant loops in the network to provide a backup data transmission route in the event that a cable is inadvertently disconnected or damaged. This feature is particularly important for industrial applications, since it could take several minutes to locate the disconnected or severed cable. For example, if the EDS-828 is used as a key communications component of a production line, several minutes of downtime could result in a big loss in production and revenue. The EDS-828 supports three different protocols to support this communication redundancy function—**Rapid Spanning Tree/ Spanning Tree Protocol (IEEE 802.1w/1D), Turbo Ring, and Turbo Ring V2.**

When configuring a redundant ring, all switches on the same ring must be configured to use the same redundancy protocol. You cannot mix the “Turbo Ring,” “Turbo Ring V2,” and STP/RSTP protocols on the same ring. The following table lists the key differences between each feature. Use this information to evaluate the benefits of each, and then determine which features are most suitable for your network.

	Turbo Ring V2	Turbo Ring	Turbo Chain	STP	RSTP
Topology	Ring	Ring	Chain	Ring, Mesh	Ring, Mesh
Recovery Time	< 20 ms	< 300 ms	< 20 ms	Up to 30 seconds	Up to 5 seconds

NOTE Most of Moxa’s managed switches now support two proprietary Turbo Ring protocols:

1. “Turbo Ring” refers to the original version of Moxa’s proprietary redundant ring protocol, which has a recovery time of under 300 ms.
2. “Turbo Ring V2” refers to the new generation Turbo Ring, which has a recovery time of under 20 ms.

In this manual, we use the terminology “Turbo Ring” ring and “Turbo Ring V2” ring to differentiate between rings configured for one or the other of these protocols.

Gigabit Ethernet Redundant Ring Capability (< 50 ms)

Ethernet has become the default data communications medium for industrial automation applications. In fact, Ethernet is often used to integrate video, voice, and high-rate industrial application data transfers into one network. The EDS-828, which comes equipped with a redundant Gigabit Ethernet protocol called Gigabit Turbo Ring, gives system maintainers a convenient means of setting up a versatile yet stable Gigabit Ethernet network. With Gigabit Turbo Ring, if any segment of the network gets disconnected, your automation system will be back to normal in less than 300 ms (Turbo Ring) or 50 ms (Turbo Ring V2).

The Turbo Ring Concept

The Turbo Ring and Turbo Ring V2 protocols identify one switch as the **master** of the network, and then automatically block packets from traveling through any of the network’s redundant loops. In the event that one branch of the ring gets disconnected from the rest of the network, the protocol automatically readjusts the ring so that the part of the network that was disconnected can reestablish contact with the rest of the network.

Initial Setup of a “Turbo Ring” or “Turbo Ring V2” ring.

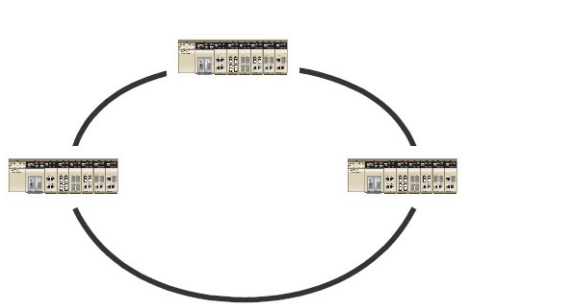

For each switch in the ring select any two ports as the redundant ports.

Connect redundant ports on neighboring switches to form the redundant ring.

The user does not need to configure any of the switches as the master to use Turbo Ring or Turbo Ring V2. If none of the switches in the ring is configured as the master, then the protocol will automatically assign master status to one of the switches. In fact, the master is only used to identify which segment in the redundant ring acts as the backup path. In the following subsections, we explain how the redundant path is selected for rings configured for Turbo Ring, and Turbo Ring V2.

Determining the Redundant Path of a “Turbo Ring” Ring

In this case, the redundant segment (i.e., the segment that will be blocked during normal operation) is determined by the number of EDS-828 units that make up the ring, and where the ring master is located.

“Turbo Ring” rings with an even number of EDS-828 units.

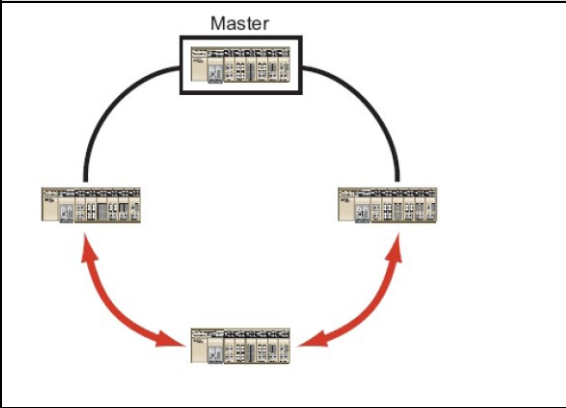

If there are $2N$ EDS-828 units (an even number) in the “Turbo Ring” ring, then the backup segment is one of the two segments connected to the $(N+1)$ st EDS-828 (i.e., the EDS-828 unit directly opposite the master).

“Turbo Ring” rings with an odd number of EDS-828 units.

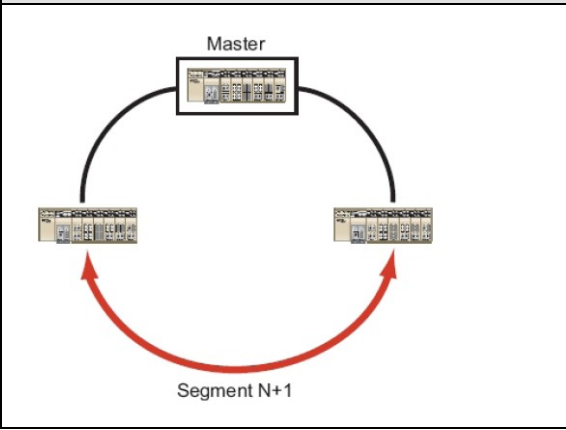

If there are $2N+1$ EDS-828 units (an odd number) in the “Turbo Ring” ring, with EDS-828 units and segments labeled counterclockwise, then segment $N+1$ will serve as the backup path.

For the example shown here, $N=1$, so that $N+1=2$.

Determining the Redundant Path of a “Turbo Ring V2” Ring.

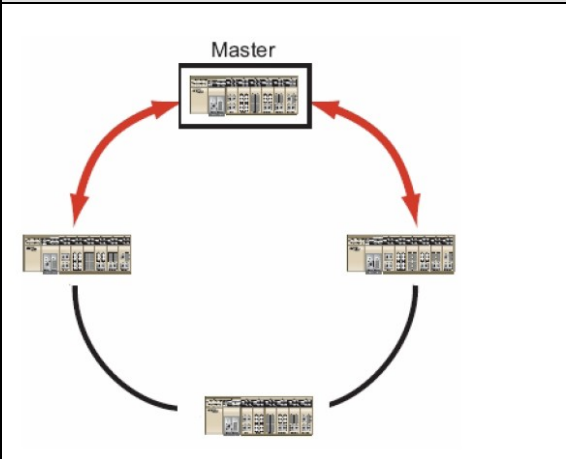

For a “Turbo Ring V2” ring, the backup segment is the segment connected to the 2nd redundant port on the master.

See Configuring “Turbo Ring V2” in the Configuring “Turbo Ring” and “Turbo Ring V2” section below.

Ring Coupling Configuration

For some systems, it may not be convenient to connect all devices in the system to create one BIG redundant ring, since some devices could be located in a remote area. For these systems, "Ring Coupling" can be used to separate the devices into different smaller redundant rings, but in such a way that they can still communicate with each other.



ATTENTION

In a VLAN environment, you must set "Redundant Port," "Coupling Port," and "Coupling Control Port" as "Trunk Port," since these ports act as the "backbone" to transmit all packets of different VLANs to different EDS-828 units.

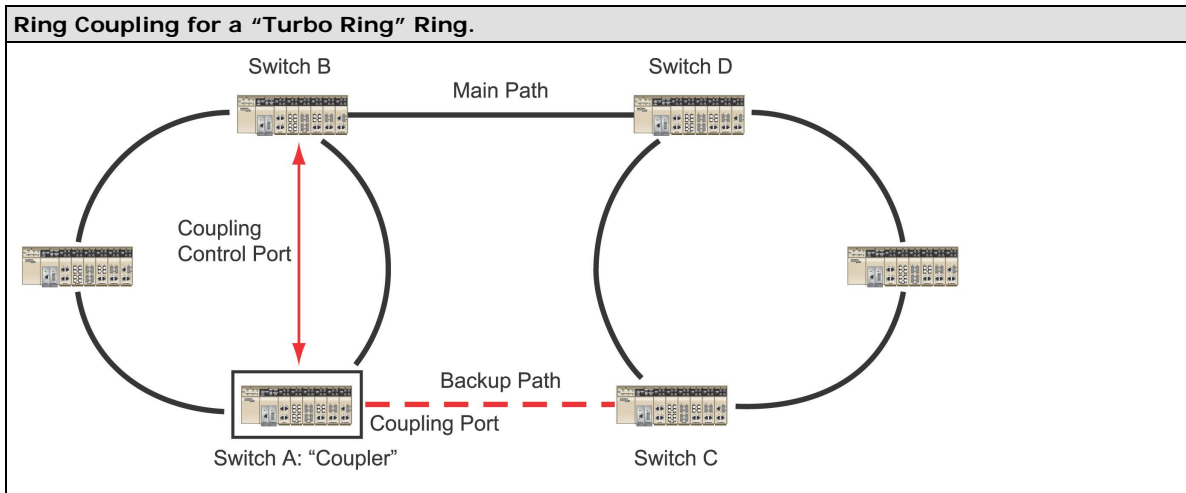

To configure the Ring Coupling function for a "Turbo Ring" ring, select two EDS-828 units (e.g., Switch A and B in the above figure) in the ring, and another two EDS-828 units in the adjacent ring (e.g., Switch C and D).

Decide which two ports in each switch are appropriate to be used as coupling ports, and then link them together. Next, assign one switch (e.g., Switch A) to be the "coupler," and connect the coupler's coupling control port with Switch B (for this example). The coupler switch (i.e., Switch A) will monitor switch B through the coupling control port to determine whether or not the coupling port's backup path should be recovered.

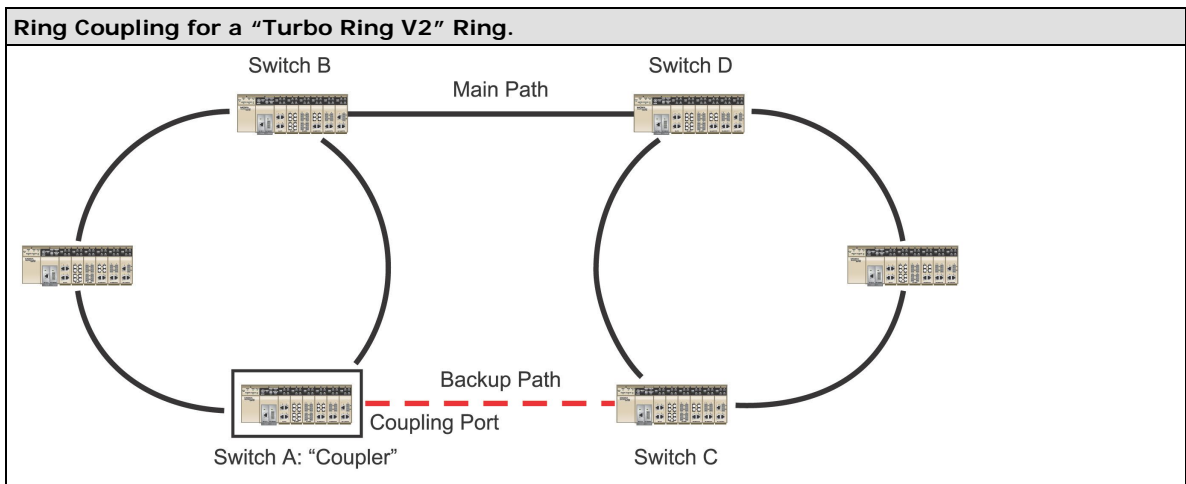

Note that the ring coupling settings for a "Turbo Ring V2" ring are different from a "Turbo Ring" ring. For Turbo Ring V2, Ring Coupling is enabled by configuring the "Coupling Port (Primary)" on Switch B, and the "Coupling Port (Backup)" on Switch A only. You do not need to set up a coupling control port, so that a "Turbo Ring V2" ring does not use a coupling control line.

The “Coupling Port (Backup)” on Switch A is used for the backup path, and connects directly to an extra network port on Switch C. The “Coupling Port (Primary)” on Switch B monitors the status of the main path, and connects directly to an extra network port on Switch D. With ring coupling established, Switch A can activate the backup path as soon as it detects a problem with the main path.



ATTENTION

Ring Coupling only needs to be enabled on one of the switches serving as the Ring Coupler. The Coupler must designate different ports as the two Turbo Ring ports and the coupling port.

NOTE

You do not need to use the same EDS-828 unit for both Ring Coupling and Ring Master.

Dual-Ring Configuration (applies only to “Turbo Ring V2”)

The “dual-ring” option provides another ring coupling configuration, in which two adjacent rings share one switch. This type of configuration is ideal for applications that have inherent cabling difficulties.

Dual-Ring for a “Turbo Ring V2” Ring.

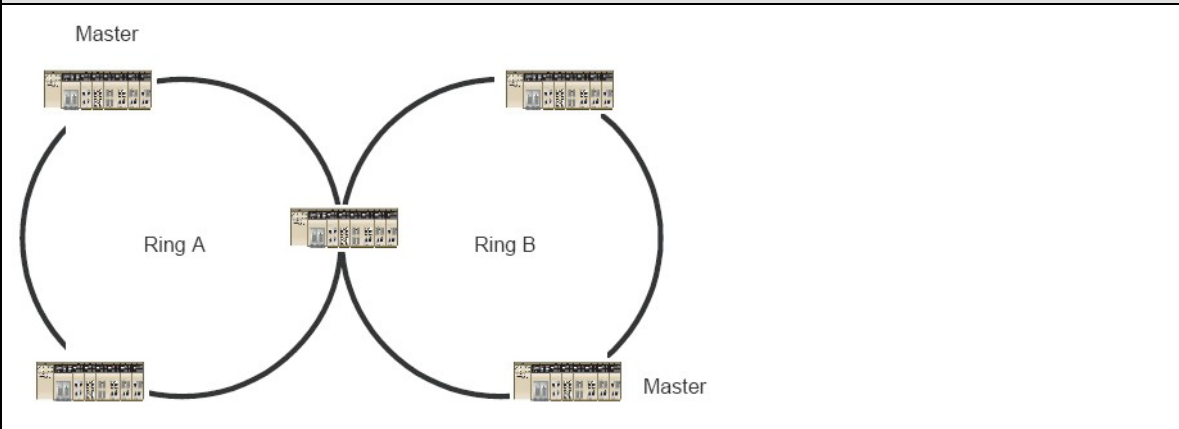

Dual-Homing Configuration (applies only to “Turbo Ring V2”)

The “dual-homing” option uses a single Ethernet switch to connect two networks. The primary path is the operating connection, and the backup path is a back-up connection that is activated in the event that the primary path connection fails.

Dual-Homing for a “Turbo Ring V2” Ring.

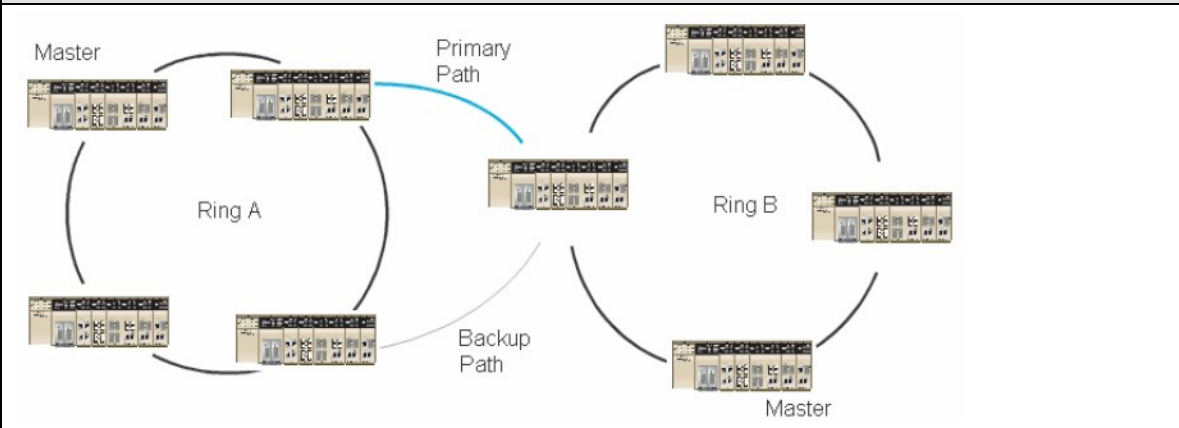

Configuring “Turbo Ring” and “Turbo Ring V2”

Use the **Communication Redundancy** page to configure select “Turbo Ring” or “Turbo Ring V2.” Note that configuration pages for these two protocols are different.

Configuring “Turbo Ring”

Explanation of “Current Status” Items

Now Active

Shows which communication protocol is in use: **Turbo Ring**, **Turbo Ring V2**, **RSTP**, or **none**.

Master/Slave

Indicates whether or not this EDS-828 is the Master of the Turbo Ring. (This field appears only when selected to operate in Turbo Ring or Turbo Ring V2 mode.)

NOTE The user does not need to set the master to use Turbo Ring. If no master is set, the Turbo Ring protocol will assign master status to one of the EDS-828 units in the ring. The master is only used to determine which segment serves as the backup path.

Redundant Port Status (1st Port, 2nd Port)

Ring Coupling Ports Status (coupling Port, Coupling Control Port)

The “Ports Status” indicators show **Forwarding** for normal transmission, **Blocking** if this port is connected to a backup path and the path is blocked, and **Link down** if there is no connection.

Explanation of “Settings” Items

Redundancy Protocol

Setting	Description	Factory Default
Turbo Ring	Select this item to change to the Turbo Ring configuration page.	RSTP (IEEE 802.1w/1D) (No ports are enabled.)
Turbo Ring V2	Select this item to change to the Turbo Ring V2 configuration Page.	
RSTP (IEEE 802.1w/1D)	Select this item to change to the RSTP configuration page.	

Set as Master

Setting	Description	Factory Default
Enable/Disable	Select this EDS-828 as Master	Not checked.
Disabled	Do not select this EDS-828 as Master.	

Redundant Ports

Setting	Description	Factory Default
1st Port	Select any port of the EDS-828 to be one of the redundant ports.	1-1
2nd Port	Select any port of the EDS-828 to be one of the redundant ports.	1-2

Enable Ring Coupling

Setting	Description	Factory Default
Enable/Disable	Select this EDS-828 as Coupler	Not checked.
Disable	Do not select this EDS-828 as coupler.	

Coupling Ports

Setting	Description	Factory Default
Coupling Port	Select any port of the EDS-828 to be the coupling port	1-3

Coupling Control Port

Setting	Description	Factory Default
Coupling Control Port	Select any port of the EDS-828 to be the coupling port	1-4

Configuring “Turbo Ring V2”

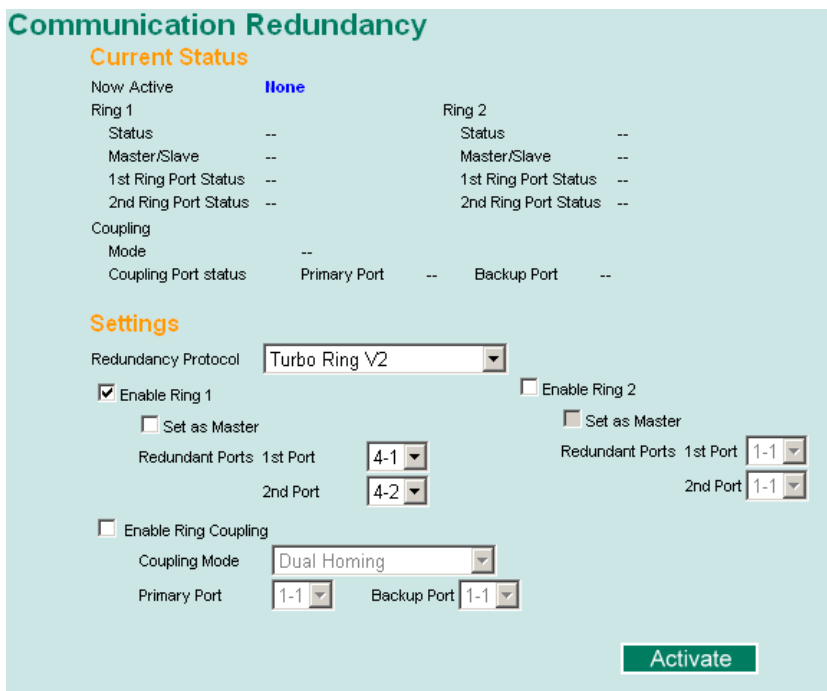

NOTE When using the Dual-Ring architecture, users must configure settings for both Ring 1 and Ring 2. In this case, the status of both rings will appear under “Current Status.”

Explanation of “Current Status” Items

Now Active

Shows which communication protocol is in use: **Turbo Ring**, **Turbo Ring V2**, **RSTP**, or **none**.

Ring 1/2—Status

Shows **Healthy** if the ring is operating normally, and shows **Break** if the ring’s backup link is active.

Ring 1/2—Master/Slave

Indicates whether or not this EDS-828 is the Master of the Turbo Ring. (This field appears only when selected to operate in Turbo Ring or Turbo Ring V2 mode.)

NOTE The user does not need to set the master to use Turbo Ring. If no master is set, the Turbo Ring protocol will assign master status to one of the EDS-828 units in the ring. The master is only used to determine which segment serves as the backup path.

Ring 1/2—1st Ring Port Status

Ring 1/2—2nd Ring Port Status

The “Ports Status” indicators show **Forwarding** for normal transmission, **Blocking** if this port is connected to a backup path and the path is blocked, and **Link down** if there is no connection.

Coupling—Mode

Indicates either **None**, **Dual Homing**, or **Ring Coupling**.

Coupling—Coupling Port status

Indicates either **Primary**, or **Backup**.

Explanation of “Settings” Items

Redundancy Protocol

Setting	Description	Factory Default
Turbo Ring	Select this item to change to the Turbo Ring configuration page.	RSTP (IEEE 802.1w/1D) (No ports are enabled.)
Turbo Ring V2	Select this item to change to the Turbo Ring V2 configuration Page.	
RSTP (IEEE 802.1w/1D)	Select this item to change to the RSTP configuration page.	

Enable Ring 1

Setting	Description	Factory Default
Enable	Enable the Ring 1 settings	Checked.
Disable	Disable the Ring 1 settings	

Enable Ring 2*

Setting	Description	Factory Default
Enable	Enable the Ring 2 settings	Not checked.
Disable	Disable the Ring 2 settings	

*You should enable both Ring 1 and Ring 2 when using the Dual-Ring architecture.

Set as Master

Setting	Description	Factory Default
Enable	Select this EDS-828 as Master	Not checked.
Disable	Do not select this EDS-828 as Master	

Redundant Ports

Setting	Description	Factory Default
1st Port	Select any port of the EDS-828 to be one of the redundant ports.	Ring 1: 1st port of last IM module Ring 2: not defined**

Setting	Description	Factory Default
2nd Port	Select any port of the EDS-828 to be one of the redundant ports.	Ring 1: 2nd port of last IM module Ring 2: not defined**

Enable Ring Coupling

Setting	Description	Factory Default
Enable	Select this EDS-828 as Coupler	Not checked
Disable	Do not select this EDS-828 as Coupler	

Coupling Mode

Setting	Description	Factory Default
Dual Homing	Select this item to change to the Dual Homing configuration page.	Primary Port: not defined** Backup Port: not defined**
Ring Coupling (backup)	Select this item to change to the Ring Coupling (backup) configuration page.	Coupling Port: not defined**
Ring Coupling (primary)	Select this item to change to the Ring Coupling (primary) configuration page	Coupling Port: not defined**

Primary/Backup Port

Setting	Description	Factory Default
Primary Port	Select any port of the EDS-828 to be the primary ports.	not defined**
Backup Port	Select any port of the EDS-828 to be the backup port.	not defined**

**You should manually adjust this port to another available port before enabling the architecture.

The Turbo Chain Concept

Moxa’s Turbo Chain is an advanced software-technology that gives network administrators the flexibility of constructing any type of redundant network topology. When using the “chain” concept, you first connect the Ethernet switches in a chain and then simply link the two ends of the chain to an Ethernet network, as illustrated in the following figure.

Turbo Chain can be used on industrial networks that have a complex topology. If the industrial network uses a multi-ring architecture, Turbo Chain can be used to create flexible and scalable topologies with a fast media-recovery time.

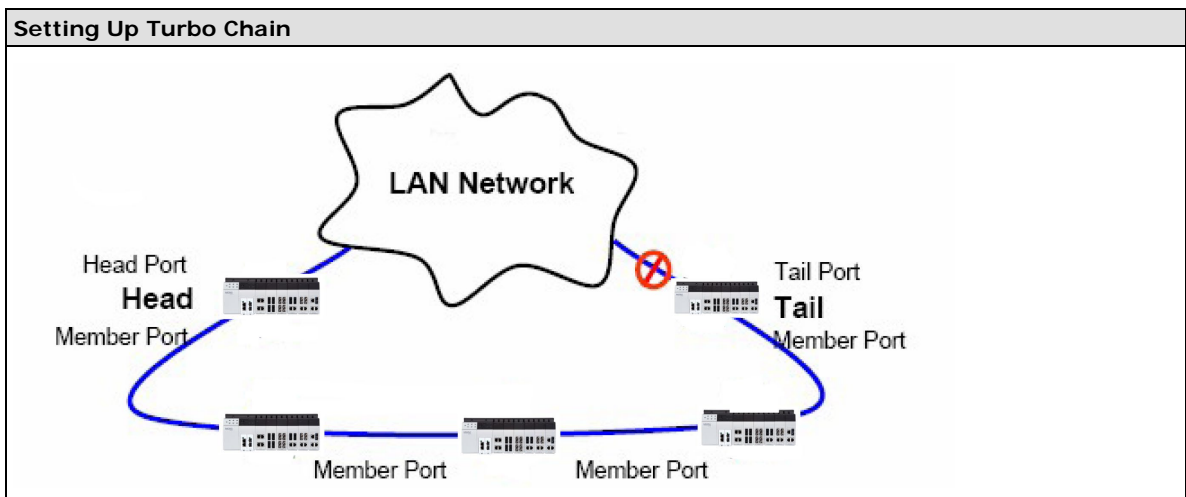

1. Select the Head switch, Tail switch, and Member switches.
2. Configure one port as the Head port and one port as the Member port in the Head switch, configure one port as the Tail port and one port as the Member port in the Tail switch, and configure two ports as Member ports in each of the Member switches.
3. Connect the Head switch, Tail switch, and Member switches as shown in the diagram.

The path connecting to the Head port is the main path, and the path connecting to the Tail port is the back up path of the Turbo Chain. Under normal conditions, packets are transmitted through the Head Port to the LAN Network. If any Turbo Chain path is disconnected, the Tail Port will be activated to continue packet transmission.

Configuring “Turbo Chain”

Head Switch Configuration

Communication Redundancy

Current Status
Now Active None

Settings

Redundancy Protocol Turbo Chain

Role Head

Port Role	Port Num	Port Status
Head Port	1-1	---
Member Port	1-2	---

Activate

Member Switch Configuration

Communication Redundancy

Current Status
Now Active None

Settings

Redundancy Protocol Turbo Chain

Role Member

Port Role	Port Num	Port Status
1st Member Port	1-1	---
2nd Member Port	1-2	---

Activate

Tail Switch Configuration

Communication Redundancy

Current Status
Now Active: **None**

Settings
Redundancy Protocol: Turbo Chain
Role: Tail

Port Role	Port Num	Port Status
Tail Port	1-1	---
Member Port	1-2	---

Activate

Explanation of “Current Status” Items

Now Active

Shows which communication protocol is in use: **Turbo Ring**, **Turbo Ring V2**, **RSTP**, **Turbo Chain** or **None**.

The “Ports Status” indicators show **Forwarding** for normal transmission, **Blocked** if this port is connected to the Tail port as a backup path and the path is blocked, and **Link down** if there is no connection.

Explanation of “Settings” Items

Redundancy Protocol

Setting	Description	Factory Default
Turbo Ring	Select this item to change to the Turbo Ring configuration page.	None
Turbo Ring V2	Select this item to change to the Turbo Ring V2 configuration page.	
Turbo Chain	Select this item to change to the Turbo Chain configuration page	
RSTP (IEEE 802.1W/1D)	Select this item to change to the RSTP configuration page.	
None	Ring redundancy is not active	

Role

Setting	Description	Factory Default
Head	Select this EDS as Head Switch	Member
Member	Select this EDS as Member Switch	
Tail	Select this EDS as Tail Switch	

Head Role

Setting	Description	Factory Default
Head Port	Select any port of the EDS to be the head port.	port 1-1
Member Port	Select any port of the EDS to be the member port.	port 1-2

Member Role

Setting	Description	Factory Default
1st Member port	Select any port of the EDS to be the 1st member port	port 1-1
2nd Member port	Select any port of the EDS to be the 2nd member port	port 1-2

Tail Role

Setting	Description	Factory Default
Tail Port	Select any port of the EDS to be the tail port.	port 1-1
Member Port	Select any port of the EDS to be the member port.	port 1-2

The STP/RSTP Concept

Spanning Tree Protocol (STP) was designed to help reduce link failures in a network, and provide protection from loops. Networks that have a complicated architecture are prone to broadcast storms caused by unintended loops in the network. The EDS-828's STP feature is disabled by default. To be completely effective, you must enable RSTP/STP on every EDS-828 connected to your network.

Rapid Spanning Tree Protocol (RSTP) implements the Spanning Tree Algorithm and Protocol defined by IEEE Std 802.1w-2001. RSTP provides the following benefits:

- The topology of a bridged network will be determined much more quickly compared to STP.
- RSTP is backward compatible with STP, making it relatively easy to deploy. For example:

Defaults to sending 802.1D style BPDUs if packets with this format are received.

STP (802.1D) and RSTP (802.1w) can operate on different ports of the same EDS-828. This feature is particularly helpful when the EDS-828's ports connect to older equipment, such as legacy switches.

You get essentially the same functionality with RSTP and STP. To see how the two systems differ, see the *Differences between RSTP and STP* section in this chapter.

NOTE The STP protocol is part of the IEEE Std 802.1D, 1998 Edition bridge specification. The explanation given below uses bridge instead of switch.

What is STP?

STP (802.1D) is a bridge-based system that is used to implement parallel paths for network traffic. STP uses a loop-detection process to:

- Locate and then disable less efficient paths (i.e., paths that have a lower bandwidth).
- Enable one of the less efficient paths if the most efficient path fails.

The figure below shows a network made up of three LANs separated by three bridges. Each segment uses at most two paths to communicate with the other segments. Since this configuration can give rise to loops, the network will overload if STP is NOT enabled.

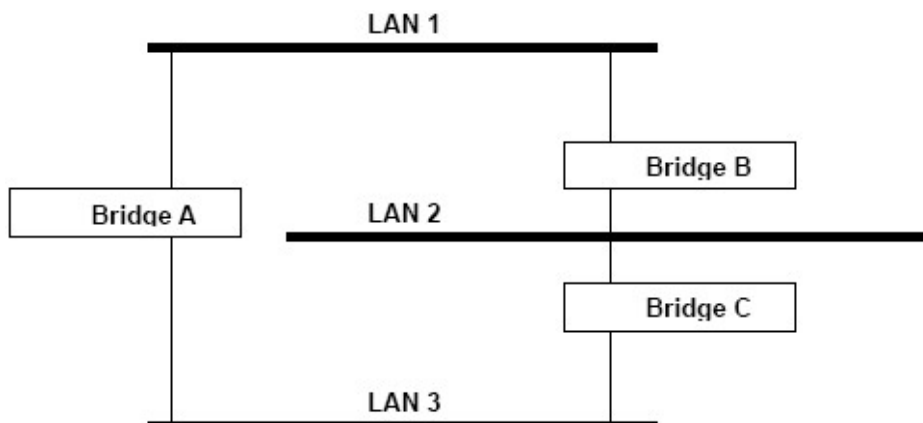

If STP is enabled, it will detect duplicate paths and prevent, or *block*, one of them from forwarding traffic. In the following example, STP determined that traffic from LAN segment 2 to LAN segment 1 should flow through Bridges C and A because this path has a greater bandwidth and is therefore more efficient.

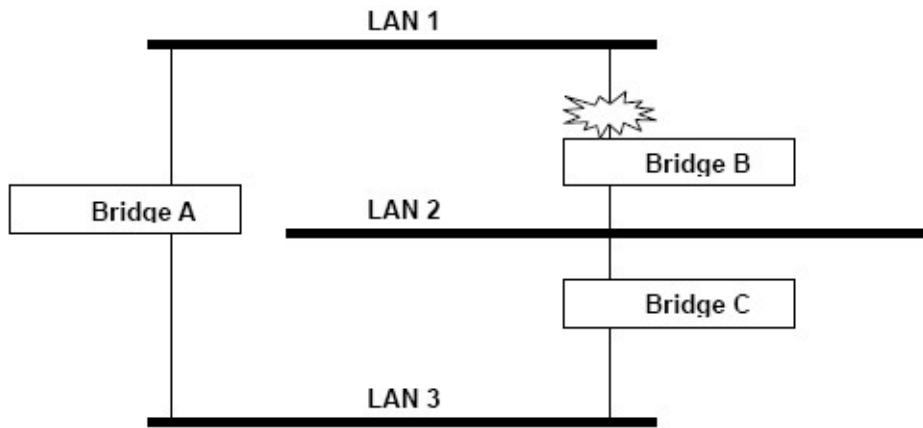

What happens if a link failure is detected? As shown in next figure, the STP process reconfigures the network so that traffic from LAN segment 2 flows through Bridge B.

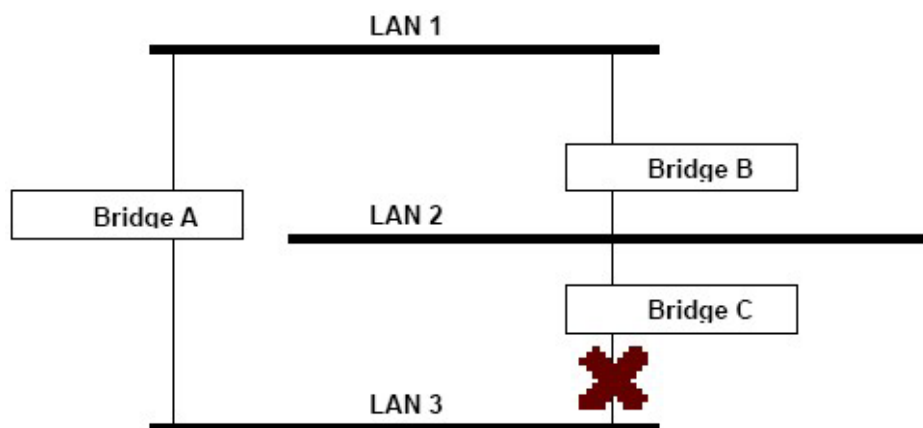

STP will determine which path between each bridged segment is most efficient, and then assigns a specific reference point on the network. When the most efficient path has been identified, the other paths are blocked. In the previous 3 figures, STP first determined that the path through Bridge C was the most efficient, and as a result, blocked the path through Bridge B. After the failure of Bridge C, STP re-evaluated the situation and opened the path through Bridge B.

How STP Works

When enabled, STP determines the most appropriate path for traffic through a network. The way it does this is outlined in the sections below.

STP Requirements

Before STP can configure the network, the system must satisfy the following requirements:

- Communication between all the bridges. This communication is carried out using Bridge Protocol Data Units (BPDUs), which are transmitted in packets with a known multicast address.
- Each bridge must have a Bridge Identifier that specifies which bridge acts as the central reference point, or Root Bridge, for the STP system—bridges with a lower Bridge Identifier are more likely to be designated as the Root Bridge. The Bridge Identifier is calculated using the MAC address of the bridge and a priority defined for the bridge. The default priority of EDS-828 is 32768.
- Each port has a cost that specifies the efficiency of each link. The efficiency cost is usually determined by the bandwidth of the link, with less efficient links assigned a higher cost. The following table shows the default port costs for a switch:

Port Speed	Path Cost 802.1D, 1998 Edition	Path Cost 802.1w-2001
10 Mbps	100	2,000,000
100 Mbps	19	200,000
1000 Mbps	4	20,000

STP Calculation

The first step of the STP process is to perform calculations. During this stage, each bridge on the network transmits BPDUs. The following items will be calculated:

- Which bridge should be the Root Bridge. The Root Bridge is the central reference point from which the network is configured.
- The Root Path Costs for each bridge. This is the cost of the paths from each bridge to the Root Bridge.
- The identity of each bridge's Root Port. The Root Port is the port on the bridge that connects to the Root Bridge via the most efficient path. In other words, the port connected to the Root Bridge via the path with the lowest Root Path Cost. The Root Bridge, however, does not have a Root Port.
- The identity of the Designated Bridge for each LAN segment. The Designated Bridge is the bridge with the lowest Root Path Cost from that segment. If several bridges have the same Root Path Cost, the one with the lowest Bridge Identifier becomes the Designated Bridge. Traffic transmitted in the direction of the Root Bridge will flow through the Designated Bridge. The port on this bridge that connects to the segment is called the Designated Bridge Port.

STP Configuration

After all the bridges on the network agree on the identity of the Root Bridge, and all other relevant parameters have been established, each bridge is configured to forward traffic only between its Root Port and the Designated Bridge Ports for the respective network segments. All other ports are blocked, which means that they will not be allowed to receive or forward traffic.

STP Reconfiguration

Once the network topology has stabilized, each bridge listens for Hello BPDUs transmitted from the Root Bridge at regular intervals. If a bridge does not receive a Hello BPDU after a certain interval (the Max Age time), the bridge assumes that the Root Bridge, or a link between itself and the Root Bridge, has gone down. This will trigger the bridge to reconfigure the network to account for the change. If you have configured an SNMP trap destination, when the topology of your network changes, the first bridge to detect the change sends out an SNMP trap.

Differences between RSTP and STP

RSTP is similar to STP, but includes additional information in the BPDUs that allow each bridge to confirm that it has taken action to prevent loops from forming when it decides to enable a link to a neighboring bridge. Adjacent bridges connected via point-to-point links will be able to enable a link without waiting to ensure that all other bridges in the network have had time to react to the change. The main benefit of RSTP is that the configuration decision is made locally rather than network-wide, allowing RSTP to carry out automatic configuration and restore a link faster than STP.

STP Example

The LAN shown in the following figure has three segments, with adjacent segments connected using two possible links. The various STP factors, such as Cost, Root Port, Designated Bridge Port, and Blocked Port are shown in the figure.

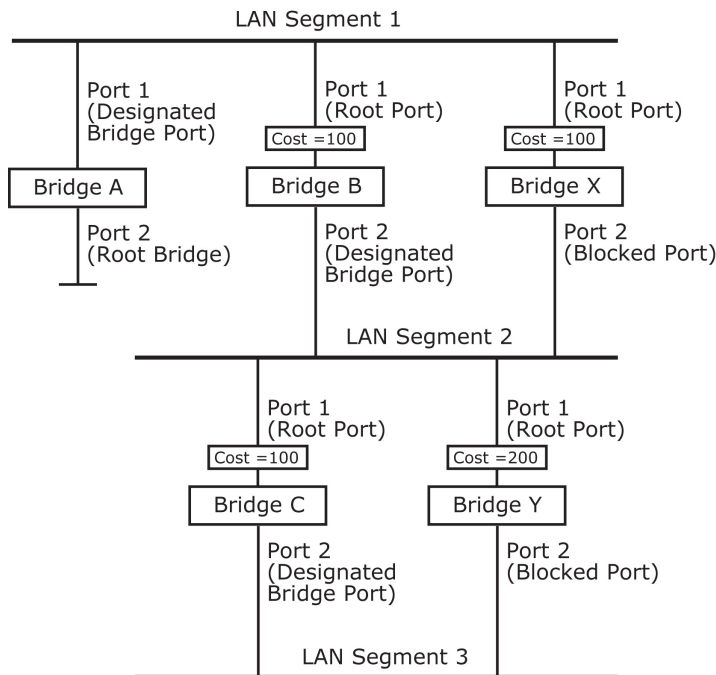

- Bridge A has been selected as the Root Bridge, since it was determined to have the lowest Bridge Identifier on the network.
- Since Bridge A is the Root Bridge, it is also the Designated Bridge for LAN segment 1. Port 1 on Bridge A is selected as the Designated Bridge Port for LAN Segment 1.
- Ports 1 of Bridges B, C, X, and Y are all Root Ports since they are nearest to the Root Bridge, and therefore have the most efficient path.
- Bridges B and X offer the same Root Path Cost for LAN segment 2. However, Bridge B was selected as the Designated Bridge for that segment since it has a lower Bridge Identifier. Port 2 on Bridge B is selected as the Designated Bridge Port for LAN Segment 2.
- Bridge C is the Designated Bridge for LAN segment 3, because it has the lowest Root Path Cost for LAN Segment 3:
 - The route through Bridges C and B costs 200 (C to B=100, B to A=100)
 - The route through Bridges Y and B costs 300 (Y to B=200, B to A=100)
- The Designated Bridge Port for LAN Segment 3 is Port 2 on Bridge C.

Using STP on a Network with Multiple VLANs

IEEE Std 802.1D, 1998 Edition, does not take into account VLANs when calculating STP information—the calculations only depend on the physical connections. Consequently, some network configurations will result in VLANs being subdivided into a number of isolated sections by the STP system. You must ensure that every VLAN configuration on your network takes into account the expected STP topology and alternative topologies that may result from link failures.

Port Speed	Path Cost 802.1D, 1998 Edition	Path Cost 802.1w-2001
10 Mbps	100	2,000,000
100 Mbps	19	200,000
1000 Mbps	4	20,000

The following figure shows an example of a network that contains VLANs 1 and 2. The VLANs are connected using the 802.1Q-tagged link between Switch B and Switch C. By default, this link has a port cost of 100 and is automatically blocked because the other Switch-to-Switch connections have a port cost of 36 (18+18). This means that both VLANs are now subdivided—VLAN 1 on Switch units A and B cannot communicate with VLAN 1 on Switch C, and VLAN 2 on Switch units A and C cannot communicate with VLAN 2 on Switch B.

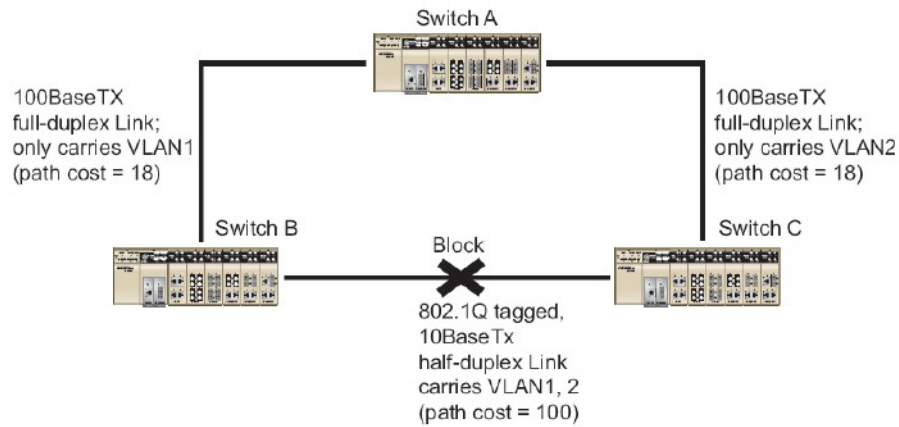

To avoid subdividing VLANs, all inter-switch connections should be made members of all available 802.1Q VLANs. This will ensure connectivity at all times. For example, the connections between Switches A and B, and between Switches A and C should be 802.1Q tagged and carrying VLANs 1 and 2 to ensure connectivity.

See the “Configuring Virtual LANs” section for more information about VLAN Tagging.

Configuring STP/RSTP

The following figures indicate which Spanning Tree Protocol parameters can be configured. A more detailed explanation of each parameter is given below the figure.

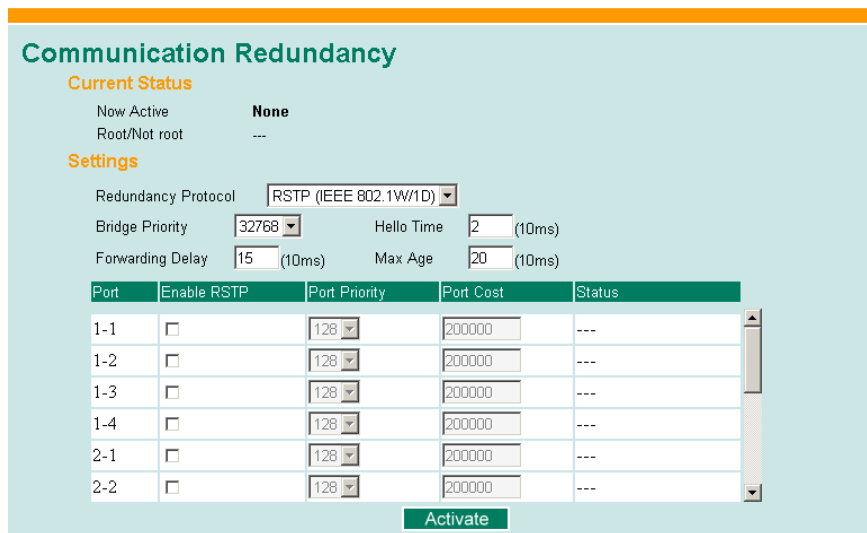

At the top of this page, the user can check the “Current Status” of this function. For RSTP, you will see:

Now Active:

This field will show which communication protocol is being used—Turbo Ring, RSTP, or neither.

Root/Not Root

This field will appear only when selected to operate in RSTP mode. It indicates whether or not this EDS-828 is the Root of the Spanning Tree (the root is determined automatically).

At the bottom of this page, the user can configure the “Settings” of this function. For RSTP, you can configure:

Protocol of Redundancy

Setting	Description	Factory Default
Turbo Ring	Select this item to change to the Turbo Ring configuration page.	None
RSTP (IEEE 802.1w/1D)	Select this item to change to the RSTP configuration page.	None

Bridge priority

Setting	Description	Factory Default
Numerical value selected by user	Increase this device's bridge priority by selecting a lower number. A device with a higher bridge priority has a greater chance of being established as the root of the Spanning Tree topology.	32768

Forwarding Delay

Setting	Description	Factory Default
Numerical value input by user	The amount of time this device waits before checking to see if it should change to a different state.	15 (sec.)

Hello time (sec.)

Setting	Description	Factory Default
Numerical value input by user	The root of the Spanning Tree topology periodically sends out a "hello" message to other devices on the network to check if the topology is healthy. The "hello time" is the amount of time the root waits between sending hello messages.	2

Max. Age (sec.)

Setting	Description	Factory Default
Numerical value input by user	If this device is not the root, and it has not received a hello message from the root in an amount of time equal to "Max. Age," then this device will reconfigure itself as a root. Once two or more devices on the network are recognized as a root, the devices will renegotiate to set up a new Spanning Tree topology.	20

Enable STP per Port

Setting	Description	Factory Default
Enable/Disable	Select to enable the port as a node on the Spanning Tree topology.	Disabled

NOTE We suggest not enabling the Spanning Tree Protocol once the port is connected to a device (PLC, RTU, etc.) as opposed to network equipment. The reason is that it will cause unnecessary negotiation.

Port Priority

Setting	Description	Factory Default
Numerical value selected by user	Increase this port's priority as a node on the Spanning Tree topology by inputting a lower number.	128

Port Cost

Setting	Description	Factory Default
Numerical value input by user	Input a higher cost to indicate that this port is less suitable as a node for the Spanning Tree topology.	200000

Port Status

Indicates the current Spanning Tree status of this port. "Forwarding" for normal transmission, or "Blocking" to block transmission.

Configuration Limits of RSTP/STP

The Spanning Tree Algorithm places limits on three of the configuration items described above:

$$[\text{Eq. 1}]: 1 \text{ sec} \leq \text{Hello Time} \leq 10 \text{ sec}$$

$$[\text{Eq. 2}]: 6 \text{ sec} \leq \text{Max. Age} \leq 40 \text{ sec}$$

$$[\text{Eq. 3}]: 4 \text{ sec} \leq \text{Forwarding Delay} \leq 30 \text{ sec}$$

These three variables are further restricted by the following two inequalities:

$$[\text{Eq. 4}]: 2 * (\text{Hello Time} + 1 \text{ sec}) \leq \text{Max. Age} \leq 2 * (\text{Forwarding Delay} - 1 \text{ sec})$$

The EDS-828's firmware will alert you immediately if any of these restrictions are violated. For example, setting Hello Time = 5 sec, Max. Age = 20 sec, and Forwarding Delay = 4 sec does not violate Eqs. 1 through 3, but does violate Eq. 4, since in this case,

$$2 * (\text{Hello Time} + 1 \text{ sec}) = 12 \text{ sec}, \text{ and } 2 * (\text{Forwarding Delay} - 1 \text{ sec}) = 6 \text{ sec}.$$

You can remedy the situation in any number of ways. One solution is simply to increase the Forwarding Delay value to at least 11 sec.

HINT: Take the following steps to avoid guessing:

Step 1: Assign a value to "Hello Time" and then calculate the left most part of Eq. 4 to get the lower limit of "Max. Age."

Step 2: Assign a value to "Forwarding Delay" and then calculate the right most part of Eq. 4 to get the upper limit for "Max. Age."

Step 3: Assign a value to "Forwarding Delay" that satisfies the conditions in Eq. 3 and Eq. 4.

Using Traffic Prioritization

The EDS-828's traffic prioritization capability provides Quality of Service (QoS) to your network by making data delivery more reliable. You can prioritize traffic on your network to ensure that high priority data is transmitted with minimum delay. Traffic can be controlled by a set of rules to obtain the required Quality of Service for your network. The rules define different types of traffic and specify how each type should be treated as it passes through the switch. The EDS-828 can inspect both IEEE 802.1p/1Q layer 2 CoS tags, and even layer 3 TOS information to provide consistent classification of the entire network. The EDS-828's QoS capability improves the performance and determinism of industrial networks for mission critical applications.

The Traffic Prioritization Concept

What is Traffic Prioritization?

Traffic prioritization allows you to prioritize data so that time-sensitive and system-critical data can be transferred smoothly and with minimal delay over a network. The benefits of using traffic prioritization are:

- Improve network performance by controlling a wide variety of traffic and managing congestion.
- Assign priorities to different categories of traffic. For example, set higher priorities for time-critical or business-critical applications.
- Provide predictable throughput for multimedia applications, such as video conferencing or voice over IP, and minimize traffic delay and jitter.
- Improve network performance as the amount of traffic grows. This will save cost by reducing the need to keep adding bandwidth to the network.

How Traffic Prioritization Works

Traffic prioritization uses the four traffic queues that are present in your EDS-828 to ensure that high priority traffic is forwarded on a different queue from lower priority traffic. This is what provides Quality of Service (QoS) to your network.

The EDS-828's traffic prioritization depends on two industry-standard methods:

- **IEEE 802.1D**—a layer 2 marking scheme.
- **Differentiated Services (DiffServ)**—a layer 3 marking scheme.

IEEE 802.1D Traffic Marking

The IEEE Std 802.1D, 1998 Edition marking scheme, which is an enhancement to IEEE Std 802.1D, enables Quality of Service on the LAN. Traffic service levels are defined in the IEEE 802.1Q 4-byte tag, which is used to carry VLAN identification as well as IEEE 802.1p priority information. The 4-byte tag immediately follows the destination MAC address and Source MAC address.

The IEEE Std 802.1D, 1998 Edition priority marking scheme assigns an IEEE 802.1p priority level between 0 and 7 to each frame. This determines the level of service that that type of traffic should receive. Refer to the table below for an example of how different traffic types can be mapped to the eight IEEE 802.1p priority levels.

IEEE 802.1p Priority Level	IEEE 802.1D Traffic Type
0	Best Effort (default)
1	Background
2	Standard (spare)
3	Excellent Effort (business critical)
4	Controlled Load (streaming multimedia)
5	Video (interactive media); less than 100 milliseconds of latency and jitter
6	Voice (interactive voice); less than 10 milliseconds of latency and jitter
7	Network Control Reserved traffic

Even though the IEEE 802.1D standard is the most widely used prioritization scheme in the LAN environment, it still has some restrictions:

- It requires an additional 4-byte tag in the frame, which is normally optional in Ethernet networks. Without this tag, the scheme cannot work.
- The tag is part of the IEEE 802.1Q header, so to implement QoS at layer 2, the entire network must implement IEEE 802.1Q VLAN tagging.

It is only supported on a LAN and not across routed WAN links, since the IEEE 802.1Q tags are removed when the packets pass through a router.

Differentiated Services (DiffServ) Traffic Marking

DiffServ is a Layer 3 marking scheme that uses the DiffServ Code Point (DSCP) field in the IP header to store the packet priority information. DSCP is an advanced intelligent method of traffic marking because you can choose how your network prioritizes different types of traffic. DSCP uses 64 values that map to user-defined service levels, allowing you to establish more control over network traffic.

Advantages of DiffServ over IEEE 802.1D are:

- Configure how you want your switch to treat selected applications and types of traffic by assigning various grades of network service to them.
- No extra tags are required in the packet.
- DSCP uses the IP header of a packet and therefore priority is preserved across the Internet.
- DSCP is backward compatible with IPV4 TOS, which allows operation with existing devices that use a layer 3 TOS enabled prioritization scheme.

Traffic Prioritization

The EDS-828 classifies traffic based on layer 2 of the OSI 7 layer model, and the switch prioritizes received traffic according to the priority information defined in the received packet. Incoming traffic is classified based upon the IEEE 802.1D frame and is assigned to the appropriate priority queue based on the IEEE 802.1p service level value defined in that packet. Service level markings (values) are defined in the IEEE 802.1Q 4-byte tag, and consequently traffic will only contain 802.1p priority markings if the network is configured with VLANs and VLAN tagging. The traffic flow through the switch is as follows:

A packet received by the EDS-828 may or may not have an 802.1p tag associated with it. If it does not, then it is given a default 802.1p tag (which is usually 0). Alternatively, the packet may be marked with a new 802.1p value, which will result in all knowledge of the old 802.1p tag being lost.

Because the 802.1p priority levels are fixed to the traffic queues, the packet will be placed in the appropriate priority queue, ready for transmission through the appropriate egress port. When the packet reaches the head of its queue and is about to be transmitted, the device determines whether or not the egress port is tagged for that VLAN. If it is, then the new 802.1p tag is used in the extended 802.1D header.

The EDS-828 will check a packet received at the ingress port for IEEE 802.1D traffic classification, and then prioritize it based upon the IEEE 802.1p value (service levels) in that tag. It is this 802.1p value that determines which traffic queue the packet is mapped to.

Traffic Queues

The EDS-828 hardware has multiple traffic queues that allow packet prioritization to occur. Higher priority traffic can pass through the EDS-828 without being delayed by lower priority traffic. As each packet arrives in the EDS-828, it passes through any ingress processing (which includes classification, marking/re-marking), and is then sorted into the appropriate queue. The switch then forwards packets from each queue.

The EDS-828 supports two different queuing mechanisms:

- **Weight Fair:** This method services all the traffic queues, giving priority to the higher priority queues. Under most circumstances, this method gives high priority precedence over low-priority, but in the event that high-priority traffic exceeds the link capacity, lower priority traffic is not blocked.
- **Strict:** This method services high traffic queues first; low priority queues are delayed until no more high priority data needs to be sent. This method always gives precedence to high priority over low-priority.

Configuring Traffic Prioritization

Quality of Service (QoS) provides a traffic prioritization capability to ensure that important data is delivered consistently and predictably. The EDS-828 Series can inspect IEEE 802.1p/1Q layer 2 CoS tags, and even layer 3 TOS information, to provide a consistent classification of the entire network. The EDS-828 Series' QoS capability improves your industrial network's performance and determinism for mission critical applications.

QoS Classification

QoS Classification

Queuing Mechanism Weight Fair(8:4:2:1)

Port Group	Inspect CoS	Inspect ToS
Group1 (2-1,2-2,2-3,2-4)	<input checked="" type="checkbox"/>	<input checked="" type="checkbox"/>

Port	Inspect CoS	Default Port Priority
2-1	<input checked="" type="checkbox"/>	3(Normal) ▼
2-2	<input checked="" type="checkbox"/>	3(Normal) ▼
2-3	<input checked="" type="checkbox"/>	3(Normal) ▼
2-4	<input checked="" type="checkbox"/>	3(Normal) ▼

Activate

The EDS-828 supports inspection of layer 3 TOS and/or layer 2 CoS tag information to determine how to classify traffic packets.

Queuing Mechanism

Setting	Description	Factory Default
Weighted Fair	The EDS-828 has 4 priority queues. In the weight fair scheme, an 8, 4, 2, 1 weighting is applied to the four priorities. This approach prevents the lower priority frames from being starved of opportunity for transmission with only a slight delay to the higher priority frames.	Weight Fair
Strict	In the Strict-priority scheme, all top-priority frames egress a port until that priority's queue is empty, and then the next lower priority queue's frames egress. This approach can cause the lower priorities to be starved of opportunity for transmitting any frames but ensures all high priority frames to egress the switch as soon as possible.	

Inspect TOS

Setting	Description	Factory Default
Enable/Disable	Check the checkbox to enable the EDS-828 to inspect the Type of Service (TOS) bits in IPV4 frame to determine the priority of each frame.	Enable

Inspect CoS

Setting	Description	Factory Default
Enable/Disable	Check the check box to enable the EDS-828 to inspect the 802.1p CoS tag in the MAC frame to determine the priority of each frame.	Enable

Default Port Priority

Setting	Description	Factory Default
Low/Normal/ Medium/High	Set the Port Default Priority of the ingress frames to different priority queues. If the received packets are not equipped with any tag information (CoS, TOS) the default port priority will take effect.	Normal

NOTE The priority of an ingress frame is determined in order by:

1. Inspect TOS
2. Inspect CoS
3. Default Port Priority

NOTE The designer can enable these classifications individually or in combination. For instance, if a 'hot,' higher priority port is required for a network design, "Inspect TOS" and "Inspect CoS" can be disabled. This setting leaves only port default priority active, which results in all ingress frames being assigned the same priority on that port.

CoS Mapping

Mapping Table of CoS Value and Priority Queues

CoS	Priority Queue
0	Low
1	Low
2	Normal
3	Normal
4	Medium
5	Medium
6	High
7	High

Activate

CoS Value and Priority Queues

Setting	Description	Factory
Low/Normal/ Medium/High	Set the mapping table of different CoS values to 4 different egress queues.	0: Low 1: Low 2: Normal 3: Normal 4: Medium 5: Medium 6: High 7: High

TOS/DiffServ Mapping

Mapping Table of ToS (DSCP) Value and Priority Queues

ToS	Level	ToS	Level	ToS	Level	ToS	Level
0x00(1)	Low	0x04(2)	Low	0x08(3)	Low	0x0C(4)	Low
0x10(5)	Low	0x14(6)	Low	0x18(7)	Low	0x1C(8)	Low
0x20(9)	Low	0x24(10)	Low	0x28(11)	Low	0x2C(12)	Low
0x30(13)	Low	0x34(14)	Low	0x38(15)	Low	0x3C(16)	Low
0x40(17)	Normal	0x44(18)	Normal	0x48(19)	Normal	0x4C(20)	Normal
0x50(21)	Normal	0x54(22)	Normal	0x58(23)	Normal	0x5C(24)	Normal
0x60(25)	Normal	0x64(26)	Normal	0x68(27)	Normal	0x6C(28)	Normal
0x70(29)	Normal	0x74(30)	Normal	0x78(31)	Normal	0x7C(32)	Normal
0x80(33)	Medium	0x84(34)	Medium	0x88(35)	Medium	0x8C(36)	Medium
0x90(37)	Medium	0x94(38)	Medium	0x98(39)	Medium	0x9C(40)	Medium
0xA0(41)	Medium	0xA4(42)	Medium	0xA8(43)	Medium	0xAC(44)	Medium
0xB0(45)	Medium	0xB4(46)	Medium	0xB8(47)	Medium	0xBC(48)	Medium
0xC0(49)	High	0xC4(50)	High	0xC8(51)	High	0xCC(52)	High

Activate

ToS (DSCP) Value and Priority Queues

Setting	Description	Factory Default
Low/Normal/ Medium/High	Set the mapping table of different TOS values to 4 different egress queues.	1 to 16: Low 17 to 32: Normal 33 to 48: Medium 49 to 64: High

Using Virtual LAN

Setting up Virtual LANs (VLANs) on your EDS-828 increases the efficiency of your network by dividing the LAN into logical segments, as opposed to physical segments. In general, VLANs are easier to manage.

The Virtual LAN (VLAN) Concept

What is a VLAN?

A VLAN is a group of devices that can be located anywhere on a network, but which communicate as if they are on the same physical segment. With VLANs, you can segment your network without being restricted by physical connections—a limitation of traditional network design. As an example, with VLANs you can segment your network according to:

- **Departmental groups**—You could have one VLAN for the Marketing department, another for the Finance department, and another for the Development department.
- **Hierarchical groups**—You could have one VLAN for directors, another for managers, and another for general staff.
- **Usage groups**—You could have one VLAN for e-mail users, and another for multimedia users.

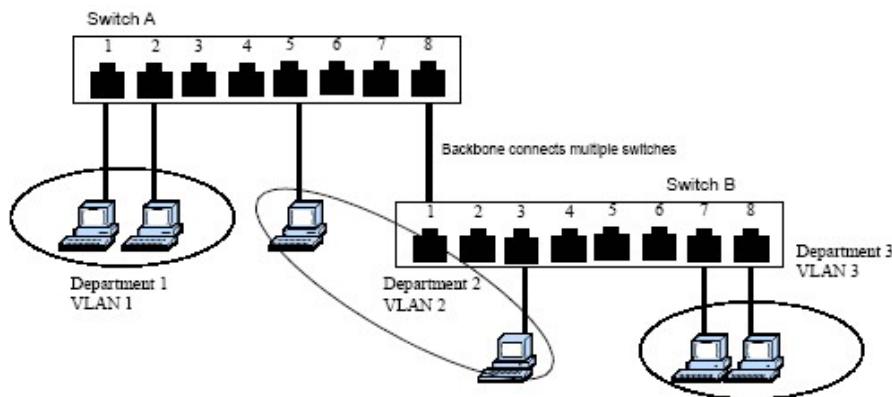

Benefits of VLANs

The main benefit of VLANs is that they provide a network segmentation system that is far more flexible than traditional networks. Using VLANs also provides you with three other benefits:

- **VLANs ease the relocation of devices on networks:** With traditional networks, network administrators spend much of their time dealing with moves and changes. If users move to a different subnetwork, the addresses of each host must be updated manually. With a VLAN setup, if a host on VLAN *Marketing*, for example, is moved to a port in another part of the network, and retains its original subnet membership, you only need to specify that the new port is on VLAN *Marketing*. You do not need to carry out any re-cabling.
- **VLANs provide extra security:** Devices within each VLAN can only communicate with other devices on the same VLAN. If a device on VLAN *Marketing* needs to communicate with devices on VLAN *Finance*, the traffic must pass through a routing device or Layer 3 switch.
- **VLANs help control traffic:** With traditional networks, congestion can be caused by broadcast traffic that is directed to all network devices, regardless of whether or not they need it. VLANs increase the efficiency of your network because each VLAN can be set up to contain only those devices that need to communicate with each other.

VLANs and Moxa EtherDevice Switch

Your EDS-828 provides support for VLANs using IEEE Std 802.1Q-1998. This standard allows traffic from multiple VLANs to be carried across one physical link. The IEEE Std 802.1Q-1998 standard allows each port on your EDS-828 to be placed in:

- Any one VLAN defined on the EDS-828.
- Several VLANs at the same time using 802.1Q tagging.

The standard requires that you define the *802.1Q VLAN ID* about each VLAN on your EDS-828 before the switch can use it to forward traffic:

Managing a VLAN

A new or initialized EDS-828 contains a single VLAN—the Default VLAN. This VLAN has the following definition:

- *VLAN Name*—Management VLAN
- *802.1Q VLAN ID*—1 (if tagging is required)

All the ports are initially placed in this VLAN, and it is the only VLAN that allows you to access the management software of the EDS-828 over the network.

Communication Between VLANs

If devices connected to a VLAN need to communicate to devices on a different VLAN, a router or Layer 3 switching device with connections to both VLANs needs to be installed. Communication between VLANs can only take place if they are all connected to a routing or Layer 3 switching device.

VLANs: Tagged and Untagged Membership

Your EDS-828 supports 802.1Q VLAN tagging, a system that allows traffic for multiple VLANs to be carried on a single physical (backbone, trunk) link. When setting up VLANs you need to understand when to use untagged and tagged membership of VLANs. Simply put, if a port is on a single VLAN it can be an untagged member, but if the port needs to be a member of multiple VLANs, tagged membership must be defined.

A typical host (e.g., clients) will be untagged members of one VLAN, defined as “Access Port” in the EDS-828, while inter-switch connections will be tagged members of all VLANs, defined as “Trunk Port” in the EDS-828.

The IEEE Std 802.1Q-1998 defines how VLANs operate within an open packet-switched network. An 802.1Q compliant packet carries additional information that allows a switch to determine which VLAN the port belongs to. If a frame is carrying the additional information, it is known as a *tagged* frame.

To carry multiple VLANs across a single physical (backbone, trunk) link, each packet must be tagged with a VLAN identifier so that the switches can identify which packets belong in which VLAN. To communicate between VLANs, a router must be used.

The EDS-828 supports two types of VLAN port settings:

- **Access Port:** The port connects to a single device that is not tagged. The user must define the default port PVID that assigns which VLAN the device belongs to. Once the ingress packet of this Access Port egresses to another Trunk Port (the port needs all packets to carry tag information), the EDS-828 will insert this PVID into this packet to help the next 802.1Q VLAN switch recognize it.
- **Trunk Port:** The port connects to a LAN that consists of untagged devices/tagged devices and/or switches and hubs. In general, the traffic of the Trunk Port must have a Tag. Users can also assign PVID to a Trunk Port. The untagged packet on the Trunk Port will be assigned the port default PVID as its VID.

The following section illustrates how to use these ports to set up different applications.

Sample Applications of VLANs using the EDS-828

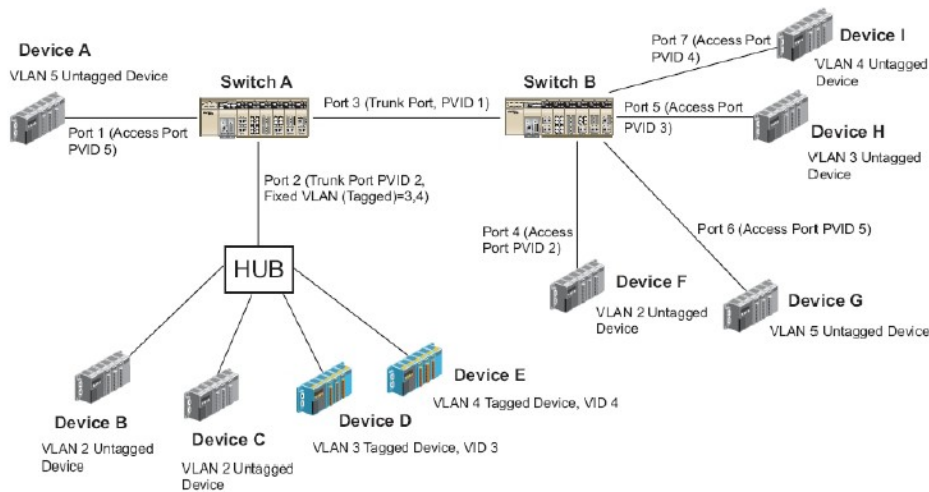

In this application,

- Port 1 connects a single untagged device and assigns it to VLAN 5; it should be configured as “Access Port” with PVID 5.
- Port 2 connects a LAN with two untagged devices belonging to VLAN 2. One tagged device with VID 3 and one tagged device with VID 4. It should be configured as “Trunk Port” with PVID 2 for untagged device and Fixed VLAN (Tagged) with 3 and 4 for tagged device. Since each port can only have one unique PVID, all untagged devices on the same port can only belong to the same VLAN.
- Port 3 connects with another switch. It should be configured as “Trunk Port.” GVRP protocol will be used through the Trunk Port.
- Port 4 connects a single untagged device and assigns it to VLAN 2; it should be configured as “Access Port” with PVID 2.
- Port 5 connects a single untagged device and assigns it to VLAN 3; it should be configured as “Access Port” with PVID 3.
- Port 6 connect a single untagged device and assigns it to VLAN 5; it should be configured as “Access Port” with PVID 5.
- Port 7 connects a single untagged device and assigns it to VLAN 4; it should be configured as “Access Port” with PVID 4.

After proper configuration:

- Packets from device A will travel through “Trunk Port 3” with tagged VID 5. Switch B will recognize its VLAN, pass it to port 6, and then remove tags received successfully by device G, and vice versa.
- Packets from device B and C will travel through “Trunk Port 3” with tagged VID 2. Switch B recognizes its VLAN, passes it to port 4, and then removes tags received successfully by device F, and vice versa.
- Packets from device D will travel through “Trunk Port 3” with tagged VID 3. Switch B will recognize its VLAN, pass to port 5, and then remove tags received successfully by device H. Packets from device H will travel through “Trunk Port 3” with PVID 3. Switch A will recognize its VLAN and pass it to port 2, but will not remove tags received successfully by device D.
- Packets from device E will travel through “Trunk Port 3” with tagged VID 4. Switch B will recognize its VLAN, pass it to port 7, and then remove tags received successfully by device I. Packets from device I will travel through “Trunk Port 3” with tagged VID 4. Switch A will recognize its VLAN and pass it to port 2, but will not remove tags received successfully by device E.

Configuring 802.1Q VLAN

VLAN Port Settings

802.1Q VLAN Settings

VLAN Mode 802.1Q VLAN ▾

Management VLAN ID

Enable GVRP

Port	Type	PVID	Fixed VLAN (Tagged)	Forbidden VLAN
1-1	Access ▾	<input type="text" value="1"/>	<input type="text"/>	<input type="text"/>
1-2	Access ▾	<input type="text" value="1"/>	<input type="text"/>	<input type="text"/>
1-3	Access ▾	<input type="text" value="1"/>	<input type="text"/>	<input type="text"/>
1-4	Access ▾	<input type="text" value="1"/>	<input type="text"/>	<input type="text"/>
2-1	Access ▾	<input type="text" value="1"/>	<input type="text"/>	<input type="text"/>
2-2	Access ▾	<input type="text" value="1"/>	<input type="text"/>	<input type="text"/>
2-3	Access ▾	<input type="text" value="1"/>	<input type="text"/>	<input type="text"/>
2-4	Access ▾	<input type="text" value="1"/>	<input type="text"/>	<input type="text"/>

Activate

To configure the EDS-828's VLANs, use the VLAN Port Setting page to configure the ports.

Management VLAN ID

Setting	Description	Factory Default
VLAN ID ranges from 1 to 4094	Set the management VLAN of this EDS-828	1

Enable GVRP

Setting	Description	Factory Default
Enable/Disable	Select the option to enable/disable the GVRP function	Enable

Port Type

Setting	Description	Factory Default
Access	This port type is used to connect single devices without tags.	Access
Trunk	Select "Trunk" port type to connect another 802.1Q VLAN aware switch or another LAN that combines tagged and/or untagged devices and/or other switches/hubs.	



ATTENTION

For communication redundancy in the VLAN environment, set "Redundant Port," "Coupling Port," and "Coupling Control Port" as "Trunk Port," since these ports act as the "backbone" to transmit all packets of different VLANs to different EDS-828 units.

Port PVID

Setting	Description	Factory Default
VID range from 1 to 4094	Set the port default VLAN ID for untagged devices that connect to the port.	1

Port Fixed VLAN List (Tagged)

Setting	Description	Factory Default
VID range from 1 to 4094	This field will be active only when selecting the "Trunk" port type. Set the other VLAN ID for tagged devices that connect to the "Trunk" port. Use commas to separate different VIDs.	None

Port Forbidden VLAN List

Setting	Description	Factory Default
VID range from 1 to 4094	This field will be active only when selecting the "Trunk" port type. Set the VLAN IDs that will not be supported by this trunk port. Use commas to separate different VIDs.	None

VLAN Table

VLAN Table

VLAN Mode
VLAN Mode 802.1Q VLAN

Management VLAN
Management VLAN 1

Current 802.1Q VLAN List

Index	VID	Joined Access Port	Joined Trunk Port
1	1	1-1, 1-2, 1-3, 1-4,	

In this table, you can review the VLAN groups that were created, Joined Access Ports, and Trunk Ports.

NOTE The physical network can have a maximum of 64 VLAN settings.

Using Multicast Filtering

Multicast filtering improves the performance of networks that carry multicast traffic. This section explains multicasts, multicast filtering, and how multicast filtering can be implemented on your EDS-828.

The Concept of Multicast Filtering

What is an IP Multicast?

A *multicast* is a packet sent by one host to multiple hosts. Only those hosts that belong to a specific multicast group will receive the multicast. If the network is set up correctly, a multicast can only be sent to an end-station or a subset of end-stations on a LAN or VLAN that belong to the multicast group. Multicast group members can be distributed across multiple subnetworks, so that multicast transmissions can occur within a campus LAN or over a WAN. In addition, networks that support IP multicast send only *one* copy of the desired information across the network until the delivery path that reaches group members diverges. To make more efficient use of network bandwidth, it is only at these points that multicast packets are duplicated and forwarded. A multicast packet has a multicast group address in the destination address field of the packet's IP header.

Benefits of Multicast

The benefits of using IP multicast are that it:

- Uses the most efficient, sensible method to deliver the same information to many receivers with only one transmission.
- Reduces the load on the source (for example, a server) since it will not need to produce several copies of the same data.

- Makes efficient use of network bandwidth and scales well as the number of multicast group members increases.
- Works with other IP protocols and services, such as Quality of Service (QoS).

Multicast transmission makes more sense and is more efficient than unicast transmission for some applications. For example, multicasts are often used for video-conferencing, since high volumes of traffic must be sent to several end-stations at the same time, but where broadcasting the traffic to all end-stations would cause a substantial reduction in network performance. Furthermore, several industrial automation protocols, such as Allen-Bradley, EtherNet/IP, Siemens Profibus, and Foundation Fieldbus HSE (High Speed Ethernet), use multicast. These industrial Ethernet protocols use publisher/subscriber communications models by multicasting packets that could flood a network with heavy traffic. IGMP Snooping is used to prune multicast traffic so that it travels only to those end destinations that require the traffic, reducing the amount of traffic on the Ethernet LAN.

Multicast Filtering

Multicast filtering ensures that only end-stations that have joined certain groups receive multicast traffic. With multicast filtering, network devices only forward multicast traffic to the ports that are connected to registered end-stations. The following two figures illustrate how a network behaves without multicast filtering, and with multicast filtering.

Network without multicast filtering

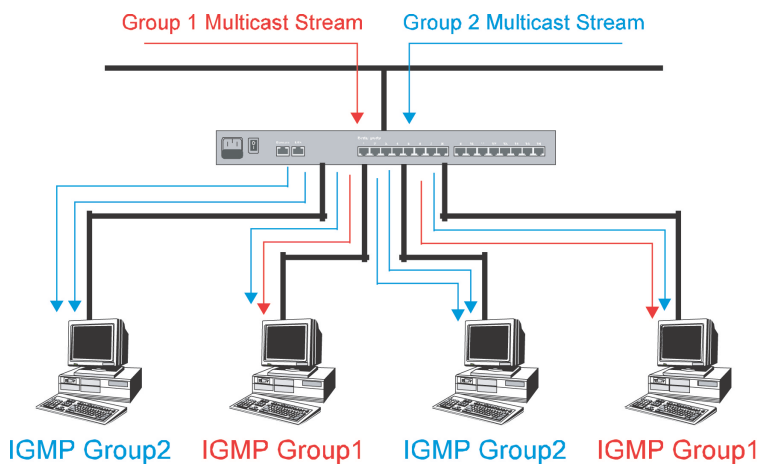

All hosts receive the multicast traffic, even if they don't need it.

Network with multicast filtering

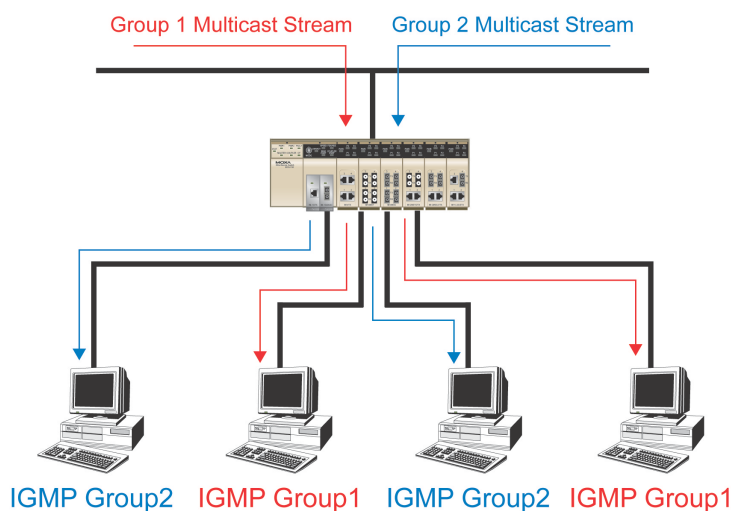

Hosts only receive dedicated traffic from other hosts belonging to the same group.

Multicast Filtering and Moxa EtherDevice Switch

The EDS-828 has three ways to achieve multicast filtering: IGMP (Internet Group Management Protocol) Snooping, GMRP (GARP Multicast Registration Protocol), and adding a static multicast MAC manually to filter multicast traffic automatically.

IGMP (Internet Group Management Protocol)

Snooping Mode

Snooping Mode allows your switch to forward multicast packets only to the appropriate ports. The switch “snoops” on exchanges between hosts and an IGMP device, such as a router, to find those ports that want to join a multicast group, and then configures its filters accordingly.

Query Mode

Query mode allows the EDS-828 to work as the Querier if it has the lowest IP address on the subnetwork to which it belongs. IGMP querying is enabled by default on the EDS-828 to help prevent interoperability issues with some multicast routers that may not follow the lowest IP address election method. Enable query mode to run multicast sessions on a network that does not contain IGMP routers (or queriers).

NOTE The EDS-828 is compatible with any device that conforms to the IGMP v2 device protocol.

IGMP Multicast Filtering

IGMP is used by IP-supporting network devices to register hosts with multicast groups. It can be used on all LANs and VLANs that contain a multicast capable IP router, and on other network devices that support multicast filtering. IGMP works as follows:

1. The IP router (or querier) periodically sends query packets to all end-stations on the LANs or VLANs that are connected to it. For networks with more than one IP router, the router with the lowest IP address is the querier. A switch with IP address lower than the IP address of any other IGMP queriers connected to the LAN or VLAN can become the IGMP querier.
2. When an IP host receives a query packet, it sends a report packet back that identifies the multicast group that the end-station would like to join.
3. When the report packet arrives at a port on a switch with IGMP Snooping enabled, the switch knows that the port should forward traffic for the multicast group, and then proceeds to forward the packet to the router.
4. When the router receives the report packet, it registers that the LAN or VLAN requires traffic for the multicast groups.
5. When the router forwards traffic for the multicast group to the LAN or VLAN, the switches only forward the traffic to ports that received a report packet.

GMRP (GARP Multicast Registration Protocol)

The EDS-828 supports IEEE 802.1D-1998 GMRP (GARP Multicast Registration Protocol), which differs from IGMP (Internet Group Management Protocol). GMRP is a MAC-based multicast management protocol, whereas IGMP is IP-based. GMRP provides a mechanism that allows bridges and end stations to register or de-register Group membership information dynamically. GMRP functions similarly to GVRP, except that GMRP registers multicast addresses on ports. When a port receives a **GMRP-join** message, it will register the multicast address to its database if the multicast address is not registered, and all the multicast packets with that multicast address are able to be forwarded from this port. When a port receives a **GMRP-leave** message, it will de-register the multicast address from its database, and all the multicast packets with this multicast address are not able to be forwarded from this port.

Static Multicast MAC

Some devices may only support multicast packets, but not support either IGMP Snooping or GMRP. The EDS-828 supports adding multicast groups manually to enable multicast filtering.

Enabling Multicast Filtering

Use the serial console or Web interface to enable or disable IGMP Snooping and IGMP querying. If IGMP Snooping is not enabled, then IP multicast traffic is always forwarded, flooding the network.

Configuring IGMP Snooping

IGMP Snooping provides the ability to prune multicast traffic so that it travels only to those end destinations that require that traffic, thereby reducing the amount of traffic on the Ethernet LAN.

IGMP Snooping Settings

IGMP Snooping Setting

Current VLAN List

IGMP Snooping Enable Query Interval (s)

IGMP Snooping Enhanced Mode

Index	VID	IGMP Snooping	Querier	Static Multicast Querier Port
1	1	<input checked="" type="checkbox"/> Enable	<input checked="" type="checkbox"/> Enable	<input type="checkbox"/> 1-1 <input type="checkbox"/> 1-2 <input type="checkbox"/> 1-3 <input type="checkbox"/> 1-4 <input type="checkbox"/> 2-1 <input type="checkbox"/> 2-2 <input type="checkbox"/> 2-3 <input type="checkbox"/> 2-4

IGMP Snooping Enable

Setting	Description	Factory Default
Enable/Disable	Select the option to enable/disable the IGMP function	Disabled

IGMP Snooping Enhanced Mode

Setting	Description	Factory Default
Enable	IGMP Multicast packets will forward to : <ul style="list-style-type: none"> Learned Multicast Querier Ports Member Ports 	Enable
Disable	IGMP Multicast packets will forward to : <ul style="list-style-type: none"> Learned multicast Querier Ports Static Multicast Querier Ports Querier Connected Ports Member Ports 	

Querier Interval

Setting	Description	Factory Default
Numerical value input by user	Set the query interval of the Querier function globally. Valid settings are from 20 to 600 seconds.	125 seconds

IGMP Snooping Enable

Setting	Description	Factory Default
Enable/Disable	Click the checkbox to enable the IGMP Snooping function globally.	Disabled

IGMP Snooping

Setting	Description	Factory Default
Enable/Disable	Click the checkbox to enable the IGMP Snooping function per VLAN.	Enabled if IGMP Snooping Enabled Globally

NOTE We suggest the following IGMP Snooping configurations

When the network includes third party switches, such as Cisco switches:

- IGMP Snooping Enable—
- IGMP Snooping Enhanced Mode—

When the network consists entirely of Moxa switches:

- IGMP Snooping Enable—
- IGMP Snooping Enhanced Mode—

Static Multicast Router Port

Setting	Description	Factory Default
Select/Deselect	Click the checkbox to select which ports will connect to the multicast routers. It's active only when IGMP Snooping is enabled.	Disabled

Querier

Setting	Description	Factory Default
Enable/Disable	Click the checkbox to enable the EDS-828's querier function.	Enabled if IGMP Snooping is Enabled Globally

NOTE At least one switch must be designated the querier or enable IGMP snooping and GMRP when enabling Turbo Ring and IGMP snooping simultaneously.

IGMP Table

The EDS-828 displays the current active IGMP groups that were detected.

Current Active IGMP Groups							
VID	Auto Learned Multicast Router Port	Static Multicast Router Port	Querier Connected Port	Act as Querier	Active IGMP Groups		
					IP	MAC	Members Port

The information includes **VID**, **Auto-learned Multicast Router Port**, **Static Multicast Router Port**, **Querier Connected Port**, and the **IP** and **MAC** addresses of active IGMP groups.

Add Static Multicast MAC

If required, the EDS-828 also supports adding multicast groups manually.

Add New Static Multicast Address to the List

Setting	Description	Factory Default
MAC Address	Input the multicast MAC address of this host.	None

Join Port

Setting	Description	Factory Default
Select/Deselect	Checkmark the appropriate check boxes to select the join ports for this multicast group.	None

Configuring GMRP

GMRP is a MAC-based multicast management protocol, whereas IGMP is IP-based. GMRP provides a mechanism that allows bridges and end stations to register or un-register Group membership information dynamically.

Port

Setting	Description	Factory Default
x-y	Displays the module (x) and port No. by module (y) of all ports that can enable the GMRP function	None

GMRP enable

Setting	Description	Factory Default
Enable/Disable	Click the check box to enable the GMRP function for the port listed in the Port column	Disable

GMRP Table

The EDS-828 displays the current active GMRP groups that were detected

GMRP Status

	Multicast Address	Fixed Ports	Learnt Ports
1	01-01-01-01-01-01	2-1,2-2,	1-3,
2	01-02-02-02-02-02	2-3,2-4,	1-3,
3	01-04-04-04-04-04	3-3,3-4,	1-3,
4	01-03-03-03-03-03	3-1,3-2,	1-3,

GMRP Status

Setting	Description
Fixed Ports	This multicast address is defined by static multicast.
Learned Ports	This multicast address is learned by GMRP.

Multicast Filtering Behavior

You can use the following table to configure the multicast filtering behavior for each port. GMRP is a MAC-based multicast management protocol, whereas IGMP is IP-based. GMRP provides a mechanism that allows bridges and end stations to register or un-register Group membership information dynamically.

Multicast Filtering Behavior

Port	Multicast Filtering Behavior
1-1	Forward Unknown ▾
1-2	Forward All
1-3	Filter Unknown
1-4	Forward Unknown ▾

Multicast Filtering Behavior

Setting	Description	Factory Default
Forward All	Select to forward all multicast frames.	Forward Unknown
Forward Unknown	Select to forward unknown multicast frames. *Note: When IGMP snooping / GMRP is enabled, or the unknown multicast frame has been added into Static Multicast Address list, the unknown multicast frame will be discarded.	
Filter Unknown	Select to filter unknown multicast frames.	

Using Bandwidth Management

In general, one host should not be allowed to occupy unlimited bandwidth, particularly when the device malfunctions. For example, so-called “broadcast storms” could be caused by an incorrectly configured topology, or a malfunctioning device. The EDS-828 series not only prevents broadcast storms, but can also be configured to a different ingress rate for all packets, giving administrators full control of their limited bandwidth to prevent undesirable effects caused by unpredictable faults.

Configuring Bandwidth Management

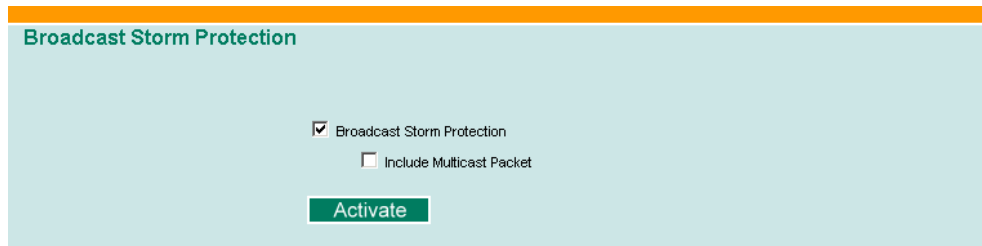

Broadcast Storm Protection

Setting	Description	Factory Default
Enable/Disable	Enable or disable the Broadcast Storm Protection for broadcast and unknown unicast packets globally.	N/A
	Check the check box to include multicast packets when enabled for Broadcast Storm Protection.	

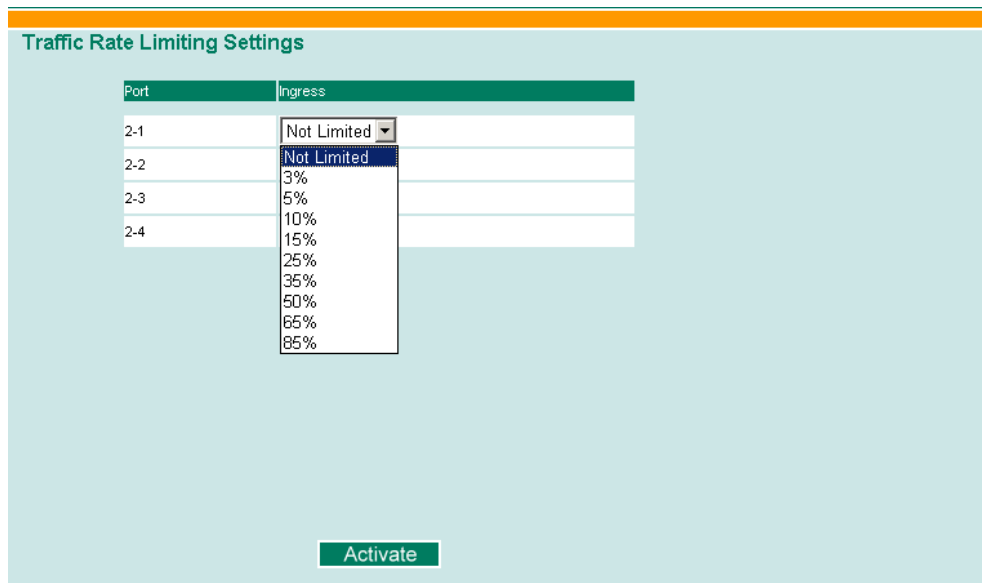

Traffic Rate Limiting Settings

Setting	Description	Factory Default
Ingress rate	Select the ingress rate for all packets from the following options: not limited, 3%, 5%, 10%, 15%, 25%, 35%, 50%, 65%, 85%	N/A

Using Port Access Control

The EDS-828 provides two kinds of Port-Base Access Control. One is IEEE 802.1X and the other is Static Port Lock.

IEEE 802.1X

The IEEE 802.1X standard defines a protocol for client/server-based access control and authentication. The protocol restricts unauthorized clients from connecting to a LAN through ports that are open to the Internet, and which otherwise would be readily accessible. The purpose of the authentication server is to check each client that requests access to the port. The client is only allowed access to the port if the client's permission is authenticated.

Static Port Lock

The EDS-828 can also be configured to protect static MAC addresses for a specific port. With the Port Lock function, these locked ports will not learn any additional addresses, but only allow traffic from preset static MAC addresses, helping to block hackers and careless usage.

The IEEE802.1X Concept

Three components are used to create an authentication mechanism based on 802.1X standards: Client/Supplicant, Authentication Server, and Authenticator.

Supplicant: The end station that requests access to the LAN and switch services and responds to the requests from the switch.

Authentication server: The server that performs the actual authentication of the supplicant.

Authenticator: Edge switch or wireless access point that acts as a proxy between the supplicant and the authentication server, requesting identity information from the supplicant, verifying the information with the authentication server, and relaying a response to the supplicant.

The EDS-828 acts as an authenticator in the 802.1X environment. A supplicant and an authenticator exchange EAPOL (Extensible Authentication Protocol over LAN) frames with each other. We can either use an external RADIUS server as the authentication server, or implement the authentication server in the EDS-828 by using a Local User Database as the authentication look-up table. When we use an external RADIUS server as the authentication server, the authenticator and the authentication server exchange EAP frames between each other.

Authentication can be initiated either by the supplicant or the authenticator. When the supplicant initiates the authentication process, it sends an "EAPOL-Start" frame to the authenticator. When the authenticator initiates the authentication process or when it receives an "EAPOL Start" frame, it sends an "EAP Request/Identity" frame to ask for the username of the supplicant. The following actions are described below:

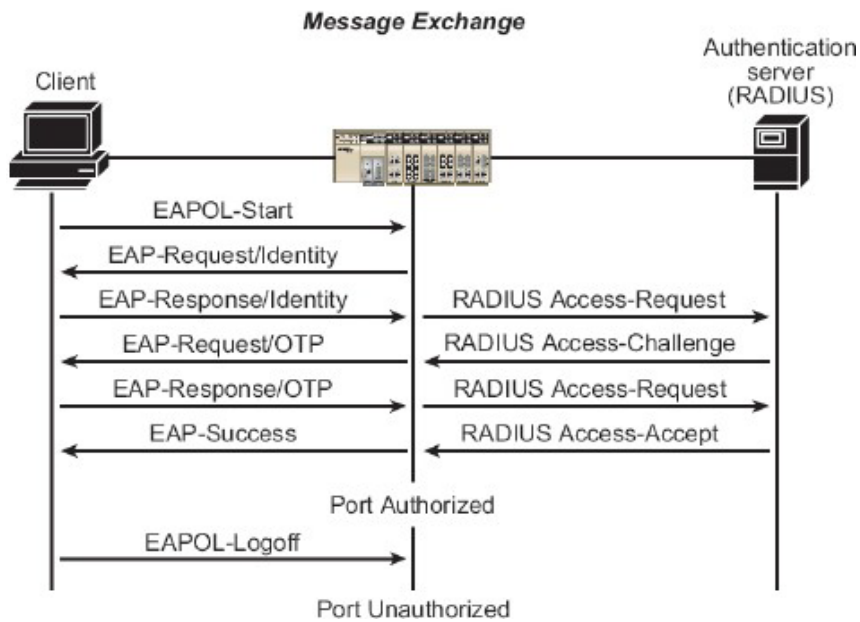

1. When the supplicant receives an "EAP Request/Identity" frame, it sends an "EAP Response/Identity" frame with its username back to the authenticator.
2. If the RADIUS server is used as the authentication server, the authenticator relays the "EAP Response/Identity" frame from the supplicant by encapsulating it into a "RADIUS Access-Request" frame and sends to the RADIUS server. When the authentication server receives the frame, it looks up its database to check if the username exists. If the username is not present, the authentication server replies with a "RADIUS Access-Reject" frame to the authenticator if the server is a RADIUS server or just indicates failure to the authenticator if the Local User Database is used. The authenticator sends an "EAP-Failure" frame to the supplicant.
3. The RADIUS server sends a "RADIUS Access-Challenge," which contains an "EAP Request" with an authentication type to the authenticator to ask for the password from the client. RFC 2284 defines several EAP authentication types, such as "MD5-Challenge," "One-Time Password," and "Generic Token Card." Currently, only "MD5-Challenge" is supported. If the Local User Database is used, this step is skipped.
4. The authenticator sends an "EAP Request/MD5-Challenge" frame to the supplicant. If the RADIUS server is used, the "EAP Request/MD5-Challenge" frame is retrieved directly from the "RADIUS Access-Challenge" frame.
5. The supplicant responds to the "EAP Request/MD5-Challenge" by sending an "EAP Response/MD5-Challenge" frame that encapsulates the user's password using the MD5 hash algorithm.
6. If the RADIUS server is used as the authentication server, the authenticator relays the "EAP Response/MD5-Challenge" frame from the supplicant by encapsulating it into a "RADIUS Access-Request" frame along with a "Shared Secret," which must be the same within the authenticator and the RADIUS server, and sends the frame to the RADIUS server. The RADIUS server checks against the password with its database, and replies with "RADIUS Access-Accept" or "RADIUS Access-Reject" to the authenticator. If the Local User Database is used, the password is checked against its database and indicates success or failure to the authenticator.
7. The authenticator sends "EAP Success" or "EAP Failure" by the received indication from the authentication server.

Configuring IEEE 802.1X

802.1X

Setting	Description	Factory Default
Enable/Disable	Click the checkbox(es) under the 802.1X column to enable IEEE 802.1X for one or more ports. All end stations must enter usernames and passwords before access to these ports is allowed.	Disable

Database Option

Setting	Description	Factory Default
Local (Max. 32 users)	Select this option when setting the Local User Database as the authentication database.	Local
Radius	Select this option to set an external RADIUS server as the authentication database. The authentication mechanism is "EAP-MD5."	Local
Radius, Local	Select this option to make using an external RADIUS server as the authentication database the first priority. The authentication mechanism is "EAP-MD5." The first priority is to set the Local User Database as the authentication database.	Local

Radius Server

Setting	Description	Factory Default
IP address or domain name	The IP address or domain name of the RADIUS server	localhost

Server Port

Setting	Description	Factory Default
Numerical	The UDP port of the RADIUS Server	1812

Shared Key

Setting	Description	Factory Default
alphanumeric (Max. 40 characters)	A key to be shared between the external RADIUS server and the EDS-828. Both ends must be configured to use the same key.	None

Re-Auth Period

Setting	Description	Factory Default
Enable/Disable	Select to require re-authentication of the client after a preset time period of no activity has elapsed.	Disable

Re-Auth

Setting	Description	Factory Default
Numerical (60-65535 sec.)	Specify how frequently the end stations need to reenter usernames and passwords in order to stay connected.	3600 seconds

802.1X Re-Authentication

The EDS-828 can force connected devices to be re-authorized manually.

Port	802.1X
1-3	<input checked="" type="checkbox"/> Re-Authenticate
1-4	<input checked="" type="checkbox"/> Re-Authenticate

Activate

802.1X Re-Authentication

Setting	Description	Factory Default
Enable/Disable	Click the check box to enable 802.1X Re-Authentication	Disable

Local User Database Setup

When setting the Local User Database as the authentication database, set the database first.

Local User Database Setup

Current Local Database

<input type="checkbox"/> Select All	Index	User Name	Description
<input type="checkbox"/>	1	plc one	PLC one for gas monitoring

Remove Select

Add New User

User Name

Password

Description

Activate

Local User Database Setup

Setting	Description	Factory Default
User Name (Max. 30 characters)	User Name for Local User Database	None
Password (Max. 16 characters)	Password for Local User Database	None
Description (Max. 30 characters)	Description for Local User Database	None

NOTE The user name for the Local User Database is case-insensitive.

Port Access control Table

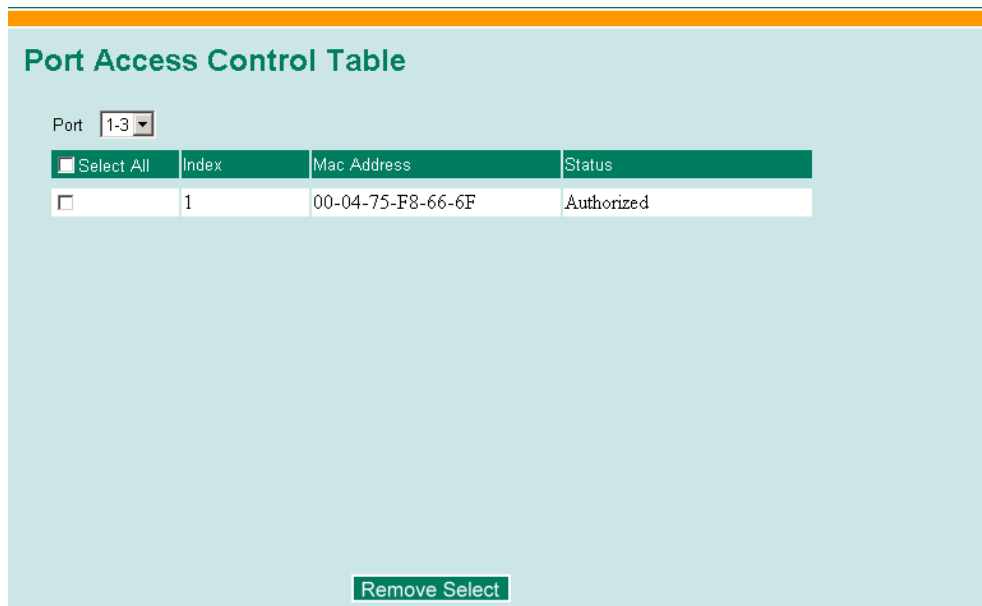

The port status will show authorized or unauthorized.

Configuring Static Port Lock

The EDS-828 also supports adding multicast groups manually if required.

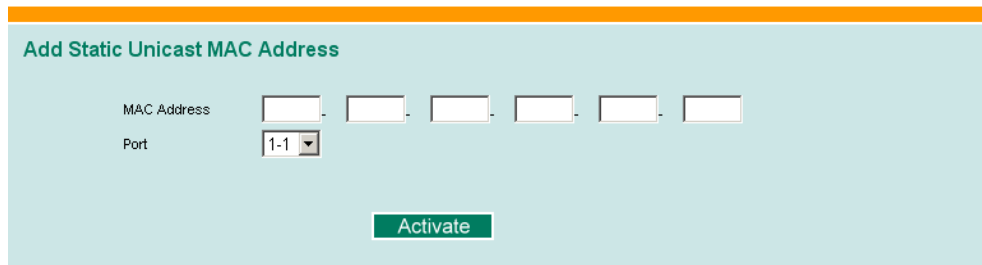

Add Static Unicast MAC Address

Setting	Description	Factory Default
MAC Address	Add the static unicast MAC address into the address table.	None
Port	Fix the static address with a dedicated port.	1-1

Using IP Filter

The EDS-828 provides an 8-entity IP filter for each port. You can specify the port and then key in the IPs from which you will accept packets. Packets from other IPs will be rejected. These settings start working right after the **Activate** button is clicked.

IP Filter

Port

Index	IP Address
1	<input type="text" value="192.168.15.3"/>
2	<input type="text" value="192.168.15.4"/>
3	<input type="text"/>
4	<input type="text"/>
5	<input type="text"/>
6	<input type="text"/>
7	<input type="text"/>
8	<input type="text"/>

Using Auto Warning

Since industrial Ethernet devices are often located at the endpoints of a system, these devices will not always know what is happening elsewhere on the network. This means that an industrial Ethernet switch that connects to these devices must provide system maintainers with real-time alarm messages. Even when control engineers are out of the control room for an extended period of time, they can still be informed of the status of devices almost instantaneously when exceptions occur. The EDS-828 supports different approaches to warn engineers automatically, such as email and relay output. It also supports two digital inputs to integrate sensors into your system to automate alarms by email and relay output.

Configuring Email Warning

The Auto Email Warning function uses e-mail to alert the user when certain user-configured events take place.

Three basic steps are required to set up the Auto Warning function:

1. **Configuring Email Event Types**

Select the desired **Event types** from the Console or Web Browser Event type page (a description of each event type is given later in the *Email Alarm Events setting* subsection).

2. **Configuring Email Settings**

To configure the EDS-828's email setup from the Console interface or browser interface, enter your Mail Server IP/Name (IP address or name), Account Name, Account Password, Retype New Password, and the email address(es) to which warning messages will be sent.

3. **Activate your settings and if necessary, test the email**

After configuring and activating your EDS-828's Event Types and Email Setup, you can use the **Test Email** function to see if your e-mail addresses and mail server address have been properly configured.

Email Alarm Events Settings

Email Alarm Events Settings

System Events

Switch Cold Start
 Switch Warm Start
 Power Transition(On->Off)
 Power Transition(Off->On)
 DI 1(Off)
 DI 1(On)
 DI 2(Off)
 DI 2(On)
 Config. Change
 Auth. Failure
 Comm. Redundancy Topology Changed

Port Events

Port	Link-ON	Link-OFF	Traffic-Overload	Traffic-Threshold(%)	Traffic-Duration(s)
1-1	<input type="checkbox"/>	<input type="checkbox"/>	<input type="checkbox"/>	<input type="text" value="0"/>	<input type="text" value="1"/>
1-2	<input type="checkbox"/>	<input type="checkbox"/>	<input type="checkbox"/>	<input type="text" value="0"/>	<input type="text" value="1"/>
1-3	<input type="checkbox"/>	<input type="checkbox"/>	<input type="checkbox"/>	<input type="text" value="0"/>	<input type="text" value="1"/>
1-4	<input type="checkbox"/>	<input type="checkbox"/>	<input type="checkbox"/>	<input type="text" value="0"/>	<input type="text" value="1"/>
2-1	<input type="checkbox"/>	<input type="checkbox"/>	<input type="checkbox"/>	<input type="text" value="0"/>	<input type="text" value="1"/>
2-2	<input type="checkbox"/>	<input type="checkbox"/>	<input type="checkbox"/>	<input type="text" value="0"/>	<input type="text" value="1"/>
2-3	<input type="checkbox"/>	<input type="checkbox"/>	<input type="checkbox"/>	<input type="text" value="0"/>	<input type="text" value="1"/>
2-4	<input type="checkbox"/>	<input type="checkbox"/>	<input type="checkbox"/>	<input type="text" value="0"/>	<input type="text" value="1"/>

Activate

Event Types

Event Types can be divided into two basic groups: **System Events** and **Port Events**. System Events are related to the overall function of the switch, whereas Port Events are related to the activity of a specific port.

System Event	Warning e-mail is sent when...
Switch Cold Start	Power is cut off and then reconnected.
Switch Warm Start	The EDS-828 is rebooted, such as when network parameters are changed (IP address, subnet mask, etc.).
Power Transition (On→Off)	The EDS-828 is powered down.
Power Transition (Off→On)	The EDS-828 is powered up.
DI1 (On→Off)	Digital Input 1 is triggered by on to off transition
DI1 (Off→On)	Digital Input 1 is triggered by off to on transition
DI2 (On→Off)	Digital Input 2 is triggered by on to off transition
DI2 (Off→On)	Digital Input 2 is triggered by off to on transition
Configuration Change Activated	Any configuration item has been changed.
Comm. Redundancy Topology Changed	If any Spanning Tree Protocol switches have changed their position (applies only to the root of the tree). If the Master of the Turbo Ring has changed or the backup path is activated.
Authentication Failure	An incorrect password is entered.

Port Event	Warning e-mail is sent when...
Link-on	The port is connected to another device.
Link-off	The port is disconnected (e.g., the cable is pulled out, or the opposing device shuts down).
Traffic-Overload	The port's traffic surpasses the Traffic-Threshold for that port (provided this item is Enabled).
Traffic-Threshold (%)	Enter a nonzero number if the port's Traffic-Overload item is Enabled.
Traffic-Duration (sec.)	A Traffic-Overload warning is sent every Traffic-Duration seconds if the average Traffic-Threshold is surpassed during that time period.

NOTE The Traffic-Overload, Traffic-Threshold (%), and Traffic-Duration (sec.) Port Event items are related. If you Enable the Traffic-Overload event, then be sure to enter a nonzero Traffic-Threshold percentage, as well as a Traffic-Duration between 1 and 300 seconds.

NOTE Warning e-mail messages will have sender given in the form:
 Moxa_EtherDevice_Switch_0001@Switch_Location
 where Moxa_EtherDevice_Switch is the default Switch Name, 0001 is the EDS-828's serial number, and Switch_Location is the default Server Location.
 Refer to the Basic Settings section to see how to modify Switch Name and Switch Location.

Email Warning Event Settings

Email Warning Events Settings

Mail Server IP/Name:

SMTP Port:

Account Name :

Account Password :

Change Account Password

Old Password :

New Password :

Retype Password :

1st email address :

2nd email address :

3rd email address :

4th email address :

Mail Server IP/Name and SMTP Port

Setting	Description	Factory Default
IP address	The IP Address of your email server.	None
SMTP	The port number of your SMTP server.	25

Account Name

Setting	Description	Factory Default
Max. 45 Charters	Your email account.	None

Password Setting

Setting	Description	Factory Default
Disable/Enable to change Password	To reset the Password from the Web Browser interface, click the Change password check-box, type the Old Password, type the New Password, retype the New password, and then click on Activate; Max. 45 Characters.	Disable
Old Password	Type the current password when changing the password	None
New Password	Type new password when enabled to change password; Max. 45 Characters.	None
Retype Password	If you type a new password in the Password field, you will be required to retype the password in the Retype new password field before updating the new password.	None

Email Address

Setting	Description	Factory Default
Max. 30 characters	You can set up to 4 email addresses to receive alarm emails from the EDS-828.	None

Send Test Email

After finishing with the email settings, you should first press the "Activate" button to activate those settings, and then press the "Send Test Email" button to verify that the settings are correct.

NOTE Auto warning e-mail messages will be sent through an authentication protected SMTP server that supports the CRAM-MD5, LOGIN, and PAIN methods of SASL (Simple Authentication and Security Layer) authentication mechanism.

We strongly recommend not entering your Account Name and Account Password if auto warning e-mail messages can be delivered without using an authentication mechanism.

Configuring Relay Warning

The Auto Relay Warning function uses relay output to alert the user when certain user-configured events take place. There are two basic steps required to set up the Relay Warning function:

1. **Configuring Relay Event Types**

Select the desired **Event types** from the Console or Web Browser Event type page (a description of each event type is given later in the *Relay Alarm Events setting* subsection).

2. **Activate your settings**

After completing the configuration procedure, you will need to activate your EDS-828's Relay Event Types.

Relay Alarm Event Settings

Relay Warning Events Settings

System Events

Override Relay 1 Warning Settings

Power Input 1 failure(On->Off)

DI 1 (Off) DI 1 (On)

Turbo Ring Break

Override Relay 2 Warning Settings

Power Input 2 failure(On->Off)

DI 2 (Off) DI 2 (On)

Port Events

Port	Link	Traffic-Overload	Rx-Threshold(%)	Traffic-Duration(s)
1-1	<input type="text" value="Ignore"/> <input type="button" value="v"/>	<input type="text" value="Disable"/> <input type="button" value="v"/>	<input type="text" value="1"/>	<input type="text" value="1"/>
1-2	<input type="text" value="Ignore"/> <input type="button" value="v"/>	<input type="text" value="Disable"/> <input type="button" value="v"/>	<input type="text" value="1"/>	<input type="text" value="1"/>
1-3	<input type="text" value="Ignore"/> <input type="button" value="v"/>	<input type="text" value="Disable"/> <input type="button" value="v"/>	<input type="text" value="1"/>	<input type="text" value="1"/>
1-4	<input type="text" value="Ignore"/> <input type="button" value="v"/>	<input type="text" value="Disable"/> <input type="button" value="v"/>	<input type="text" value="1"/>	<input type="text" value="1"/>
2-1	<input type="text" value="Ignore"/> <input type="button" value="v"/>	<input type="text" value="Disable"/> <input type="button" value="v"/>	<input type="text" value="1"/>	<input type="text" value="1"/>
2-2	<input type="text" value="Ignore"/> <input type="button" value="v"/>	<input type="text" value="Disable"/> <input type="button" value="v"/>	<input type="text" value="1"/>	<input type="text" value="1"/>
2-3	<input type="text" value="Ignore"/> <input type="button" value="v"/>	<input type="text" value="Disable"/> <input type="button" value="v"/>	<input type="text" value="1"/>	<input type="text" value="1"/>
2-4	<input type="text" value="Ignore"/> <input type="button" value="v"/>	<input type="text" value="Disable"/> <input type="button" value="v"/>	<input type="text" value="1"/>	<input type="text" value="1"/>

Event Types

Event Types can be divided into two basic groups: **System Events** and **Port Events**. System Events are related to the overall function of the switch, whereas Port Events are related to the activity of a specific port.

The EDS-828 supports two relay outputs. You can configure which relay output is related to which events. This helps administrators identify the importance of the different events.

System Event	Warning Relay output is triggered when...
Power Transition (On→Off)	The EDS-828 is powered on.
Power Transition (Off→On)	The EDS-828 is powered down.
DI1 (On→Off)	Digital Input 1 is triggered by on to off transition
DI1 (Off→On)	Digital Input 1 is triggered by off to on transition
DI2 (On→Off)	Digital Input 2 is triggered by on to off transition
DI2 (Off→On)	Digital Input 2 is triggered by off to on transition
Turbo Ring Break	Turbo Ring is broken
Port Event	Warning e-mail is sent when...
Link-on	The port is connected to another device.
Link-off	The port is disconnected (e.g., the cable is pulled out, or the opposing device shuts down).
Traffic-Overload	The port's traffic surpasses the Traffic-Threshold for that port (provided this item is Enabled).
Traffic-Threshold (%)	Enter a nonzero number if the port's Traffic-Overload item is Enabled.
Traffic-Duration (sec.)	A Traffic-Overload warning is sent every Traffic-Duration seconds if the average Traffic-Threshold is surpassed during that time period.

NOTE The Traffic-Overload, Traffic-Threshold (%), and Traffic-Duration (sec) Port Event items are related. If you Enable the Traffic-Overload event, then be sure to enter a nonzero Traffic-Threshold percentage, as well as a Traffic-Duration between 1 and 300 seconds.

Override relay alarm settings

Click the checkbox to override the relay warning setting temporarily. Releasing the relay output will allow administrators to fix any problems with the warning condition.

Relay Alarm List

Use this table to see if any relay alarms have been issued.

Current Alarm List		
Index	Event	Relay
1	DI 1 failure (Off) !	1
2	DI 2 failure (Off) !	2
3	Port 1-2 Link failure (Off) !	1

Using Line-Swap-Fast-Recovery

The Line-Swap Fast Recovery function, which is enabled by default, allows the EDS-828 to return to normal operation extremely quickly after devices are unplugged and then re-plugged into different ports. The recovery time is on the order of a few milliseconds (compare this with standard commercial switches for which the recovery time could be on the order of several minutes). To disable the Line-Swap Fast Recovery function, or to re-enable the function after it has already been disabled, access either the Console utility's **Line-Swap recovery** page, or the Web Browser interface's **Line-Swap fast recovery** page, as shown below.

Configuring Line-Swap Fast Recovery

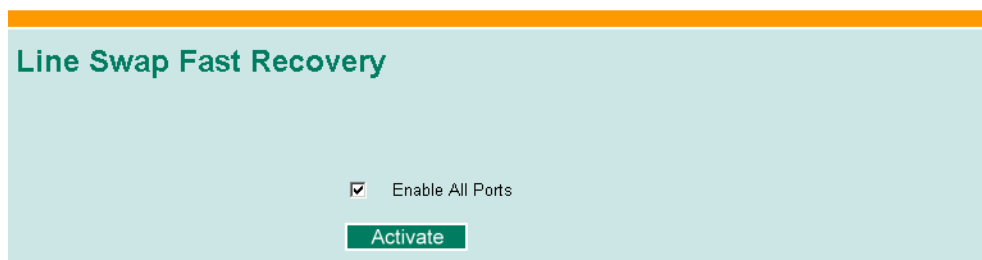

Enable Line-Swap-Fast-Recovery

Setting	Description	Factory Default
Enable/Disable	Check-mark the check box to enable the Line-Swap-Fast-Recovery function	Enable

Using Set Device IP

To reduce the effort required to set up IP addresses, the EDS-828 series comes equipped with DHCP/BootP server and RARP protocol to set up IP addresses of Ethernet-enabled devices automatically.

When enabled, the **Set device IP** function allows the EDS-828 to assign specific IP addresses automatically to connected devices that are equipped with *DHCP Client* or *RARP* protocol. In effect, the EDS-828 acts as a DHCP server by assigning a connected device with a specific IP address stored in its internal memory. Each time the connected device is switched on or rebooted, the EDS-828 sends the device the desired IP address.

Take the following steps to use the **Set device IP** function:

STEP 1—set up the connected devices

Set up those Ethernet-enabled devices connected to the EDS-828 for which you would like IP addresses to be assigned automatically. The devices must be configured to obtain their IP address automatically.

The devices' configuration utility should include a setup page that allows you to choose an option similar to Obtain an IP address automatically.

For example, Windows' TCP/IP Properties window is shown at the right. Although your device's configuration utility may look quite a bit different, this figure should give you some idea of what to look for.

You also need to decide which of the EDS-828's ports your Ethernet-enabled devices will be connected to. You will need to set up each of these ports separately, as described in the following step.

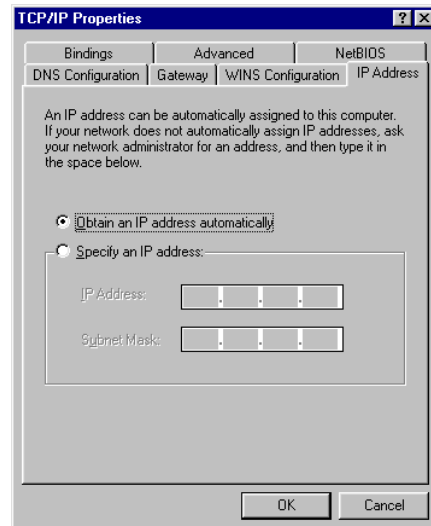

STEP 2

Configure the EDS-828's **Set device IP** function, either from the Console utility or from the Web Browser interface. In either case, you simply need to enter the **Desired IP** for each port that needs to be configured.

STEP 3

Be sure to activate your settings before exiting.

- When using the Web Browser interface, activate by clicking on the Activate button.
- When using the Console utility, activate by first highlighting the **Activate** menu option, and then press **Enter**. You should receive the **Set device IP settings are now active! (Press any key to continue)** message.

Configuring Set Device IP

Automatic Set Device IP by DHCP/BootP/RARP

Port	Device's current IP	Active function	Desired IP address
1-1	NA	--	<input type="text"/>
1-2	NA	--	<input type="text"/>
1-3	NA	--	<input type="text"/>
1-4	NA	--	<input type="text"/>
2-1	NA	--	<input type="text"/>
2-2	NA	--	<input type="text"/>
2-3	NA	--	<input type="text"/>
2-4	NA	--	<input type="text"/>

Desired IP Address

Setting	Description	Factory Default
IP Address	Set the desired IP of connected devices.	None

DHCP Relay Agent (Option 82)

The DHCP Relay Agent makes it possible for DHCP broadcast messages to be sent over routers. The DHCP Relay Agent enables DHCP clients to obtain IP addresses from a DHCP server on a remote subnet, or those that are not located on the local subnet.

Option 82 is used by the relay agent to insert additional information into the client's DHCP request. The Relay Agent Information option is inserted by the DHCP relay agent when forwarding client-originated DHCP packets to a DHCP server. Servers can recognize the Relay Agent Information option and use the information to implement IP addresses to Clients.

When Option 82 is enabled on the switch, a subscriber device is identified by the switch port through which it connects to the network (in addition to its MAC address). Multiple hosts on the subscriber LAN can be connected to the same port on the access switch and are uniquely identified.

The Option 82 information contains 2 sub-options: Circuit ID and Remote ID, which define the relationship between end device IP and the DHCP Option 82 server. The "Circuit ID" is a 4-byte number generated by the Ethernet switch—a combination of physical port number and VLAN ID. The format of the "Circuit ID" is as described below:

FF-VV-VV-PP

Where the first byte "FF" is fixed to "01", the second and the third byte "VV-VV" is formed by the port VLAN ID in hex, and the last byte "PP" is formed by the port number in hex. For example,

01-00-0F-03 is the "Circuit ID" of port number 3 with port VLAN ID 15.

The "Remote ID" is to identify the relay agent itself and it can be one of the following:

1. The IP address of the relay agent.
2. The MAC address of the relay agent.
3. A combination of IP address and MAC address of the relay agent.
4. A user-defined string.

DHCP Relay Agent

Server IP Address

1st Server

2nd Server

3rd Server

4th Server

DHCP Option 82

Enable Option 82

Type

Value

Display

DHCP Function Table

Port	Circuit-ID	Option 82
1-1	01000101	<input type="checkbox"/> Enable
1-2	01000102	<input type="checkbox"/> Enable
1-3	01000103	<input type="checkbox"/> Enable
1-4	01000104	<input type="checkbox"/> Enable
2-1	01000105	<input type="checkbox"/> Enable
2-2	01000106	<input type="checkbox"/> Enable

Server IP Address

1st Server

Setting	Description	Factory Default
IP address for the 1st DHCP server	This assigns the IP address of the 1st DHCP server that the switch tries to access.	None

2nd Server

Setting	Description	Factory Default
IP address for the 2nd DHCP server	This assigns the IP address of the 2nd DHCP server that the switch tries to access.	None

3rd Server

Setting	Description	Factory Default
IP address for the 3rd DHCP server	This assigns the IP address of the 3rd DHCP server that the switch tries to access.	None

4th Server

Setting	Description	Factory Default
IP address for the 4th DHCP server	This assigns the IP address of the 4th DHCP server that the switch tries to access.	None

DHCP Option 82

Enable Option82

Setting	Description	Factory Default
Enable or Disable	Enable or disable DHCP Option 82 function.	Disable

Type

Setting	Description	Factory Default
IP	Use switch IP address as the remote ID sub-option.	IP
MAC	Use switch MAC address as the remote ID sub-option.	IP
Client-ID	Use the combination of switch MAC address and IP address as the remote ID sub-option.	IP
Other	Use the user-defined value as the remote ID sub-option.	IP

Value

Setting	Description	Factory Default
	Displays the value which you've set.	
Max. 12 characters	If you set the DHCP Option 82 type as Other, you will need to set it here.	switch IP address

Display

Setting	Description	Factory Default
	The actual hexadecimal value set at the DHCP server for the Remote-ID. This value is automatically generated according to the Value field. Users can not modify it.	COA87FFD

DHCP Function Table

Enable

Setting	Description	Factory Default
Enable or Disable	Enable or disable DHCP Option 82 function for this port.	Disable

Using Diagnosis

The EDS-828 provides two important tools for administrators to diagnose network systems.

Mirror Port

Mirror Port Settings

Monitored port 1-1 1-2 1-3 1-4 2-1 2-2 2-3 2-4
 3-1 3-2 3-3 3-4 4-1 4-2 4-3 4-4
 5-1 5-2 5-3 5-4

Watch direction

Mirror port

The **Mirror port** function can be used to monitor data being transmitted through a specific port. This is done by setting up another port (the *mirror port*) to receive the same data being transmitted from, or both to and from, the port under observation. This allows the network administrator to “sniff” the observed port and thus keep tabs on network activity.

Take the following steps to set up the **Mirror Port** function:

STEP 1

Configure the EDS-828's **Mirror Port** function from either the Console utility or Web Browser interface. You will need to configure three settings:

- Monitored Port** Select the port number of the port whose network activity will be monitored.
- Mirror Port** Select the port number of the port that will be used to monitor the activity of the monitored port.
- Watch Direction** Select one of the following three watch direction options:
- **Output data stream**
Select this option to monitor only those data packets being sent out through the EDS-828's port.
 - **Input data stream**
Select this option to monitor only those data packets coming in through the EDS-828's port.
 - **Bi-directional**
Select this option to monitor data packets both coming into, and being sent out through, the EDS-828's port.

STEP 2

Be sure to activate your settings before exiting.

- When using the Web Browser interface, activate by clicking on the **Activate** button.
- When using the Console utility, activate by first highlighting the Activate menu option, and then press **Enter**. You should receive the **Mirror port settings are now active! (Press any key to continue)** message.

Ping

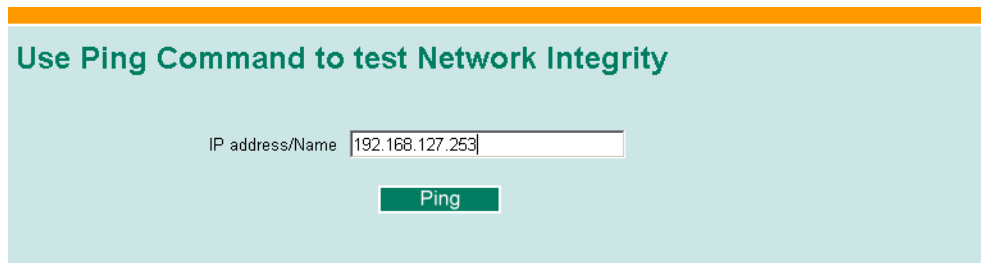

The **Ping** function uses the *ping* command to give users a simple but powerful tool for troubleshooting network problems. The function's most unique feature is that even though the ping command is entered from the user's PC keyboard, the actual ping command originates from the EDS-828 itself. In this way, the user can essentially "sit on top of the EDS-828" and send ping commands out through its ports.

To use the Ping function, type in the desired IP address, and then press **Enter** from the Console utility, or click on **Ping** when using the Web Browser interface.

LLDP Function Overview

Defined by IEEE 802.11AB, LLDP is an OSI Layer 2 Protocol that standardizes the self-identity advertisement methodology. It allows each networking device, e.g. a Moxa managed switch, to periodically inform its neighbors about its self-information and configurations. As a result, all of the devices will have knowledge about each other; and through SNMP, this knowledge can be transferred to Moxa's MXview for auto-topology and network visualization.

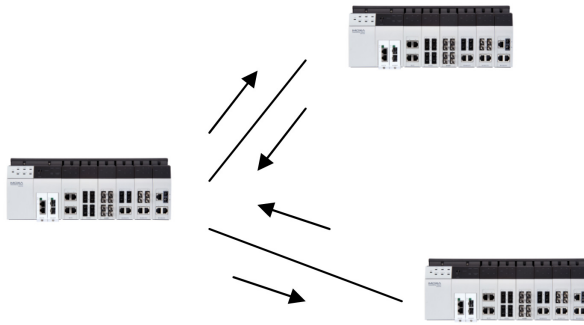

LLDP Web Interface

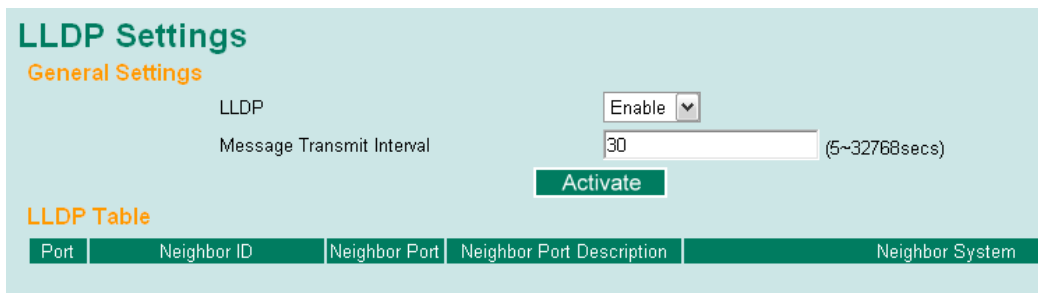

From the switch’s web interface, users have the option of either enabling or disabling the LLDP, as well as setting the LLDP transmit interval (as shown in the figure below). In addition, users are able to view each switch’s neighbor-list, which is reported by its network neighbors. Most importantly, enabling the LLDP function allows Moxa’s MXview to automatically display the network’s topology as well as system setup details such as VLAN, and Trunking for the entire network.

LLDP Settings

Enable LLDP

Setting	Description	Factory Default
Enable or Disable	Enable or disable LLDP function.	Enable

Message Transmit Interval

Setting	Description	Factory Default
Numbers from 5 to 32768 secs	Sets the transmit interval of LLDP messages. Unit is in seconds.	30 (seconds)

LLDP Table

Port	Neighbor ID	Neighbor Port	Neighbor Port Description	Neighbor System
------	-------------	---------------	---------------------------	-----------------

Port: The port number that connects to the neighbor device.

Neighbor ID: A unique entity which identifies a neighbor device; this is typically the MAC address.

Neighbor Port: The port number of the neighbor device.

Neighbor Port Description: A textual description of the neighbor device’s interface.

Neighbor System: Hostname of the neighbor device.

Using Monitor

You can monitor statistics in real time from the EDS-828's web console and serial console.

Monitor by Switch

Access the Monitor by selecting "System" from the left selection bar. Monitor by System allows the user to view a graph that shows the combined data transmission activity of all of the EDS-828's ports. Click on one of the four options—All Packets, TX Packets, RX Packets, or Error Packets—to view transmission activity of specific types of packets. Recall that TX Packets are packets sent out from the EDS-828, RX Packets are packets received from connected devices, and Error Packets are packets that did not pass TCP/IP's error checking algorithm. The All Packets option displays a graph that combines TX, RX, and Error Packet activity. The four graphs (All Packets, TX Packets, RX Packets, and Error Packets) have the same form, so we only show the All Packets graph. The graph displays data transmission activity by showing **Packets/s** (i.e., packets per second, or pps) versus **sec.** (seconds). In fact, three curves are displayed on the same graph: **Uni-cast** packets (in red color), **Multi-cast** packets (in green color), and **Broad-cast** packets (in blue color). The graph is updated every few seconds, allowing the user to analyze data transmission activity in real-time.

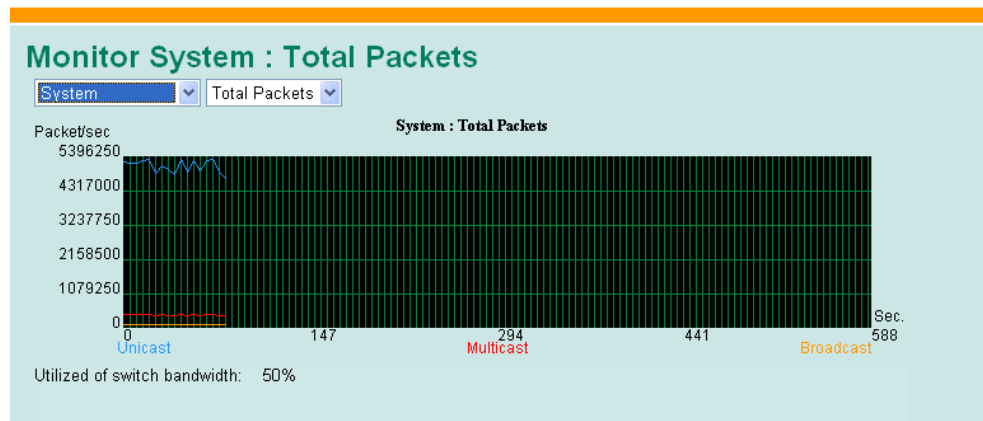

Monitor by Port

Access the Monitor by Port function by selecting **ALL Ports** or **Port i** , in which $i = 1, 2, \dots, 8$, from the left pull-down list. The **Port i** options are identical to the Monitor by System function discussed above, in that users can view graphs that show All Packets, TX Packets, RX Packets, or Error Packets activity, but in this case, only for an individual port. The **ALL Ports** option is essentially a graphical display of the individual port activity that can be viewed with the Console Monitor function discussed above. The All Ports option shows three vertical bars for each port. The height of the bar represents **Packets/s** for the type of packet, at the instant the bar is being viewed. That is, as time progresses, the height of the bar moves up or down so that the user can view the change in the rate of packet transmission. The red colored bar shows **Uni-cast** packets, the green colored bar shows **Multi-cast** packets, and the blue colored bar shows **Broad-cast** packets. The graph is updated every few seconds, allowing the user to analyze data transmission activity in real-time.

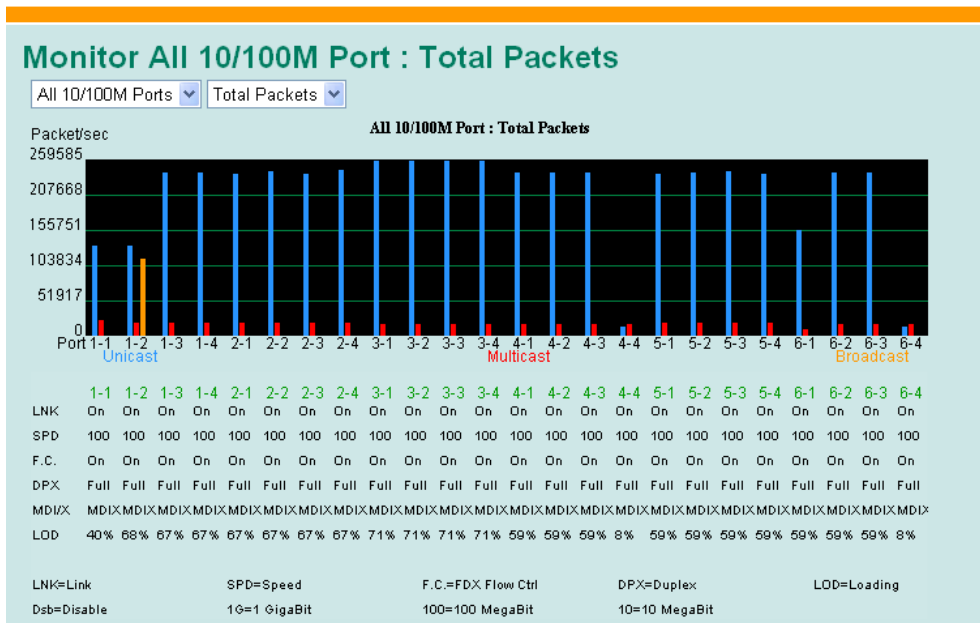

Using the MAC Address Table

This section explains the information provided by the EDS-828's MAC address table.

All Page 1/6

Index	MAC	Type	VLAN	Port
1	00-00-00-00-00-03	ucast(l)	1	1-2
2	00-00-00-00-00-05	ucast(l)	1	1-2
3	00-01-01-05-01-01	ucast(l)	1	1-2
4	00-07-e9-0b-3a-90	ucast(l)	1	1-2
5	00-09-e8-00-03-51	ucast(l)	1	1-2
6	00-09-e8-00-46-af	ucast(l)	1	1-2
7	00-0a-0b-00-03-64	ucast(l)	1	1-2
8	00-0a-19-03-69-14	ucast(l)	1	1-2
9	00-0a-19-74-12-13	ucast(l)	1	1-2
10	00-0d-88-18-4e-4a	ucast(l)	1	1-2

The MAC Address table can be configured to display the following the EDS-828 MAC address groups.

All	Select this item to show all EDS-828's MAC addresses
All Learned	Select this item to show all EDS-828's Learned MAC addresses
All Static	Select this item to show all EDS-828's Static / Static Multicast MAC addresses
All Multicast	Select this item to show all EDS-828's Multicast MAC addresses
Port x	Select this item to show all MAC addresses of dedicated ports

The table will display the following information:

MAC	This field shows the MAC address
Type	This field shows the type of this MAC address
Port	This field shows the port that this MAC address belongs to

Using Layer 3 Settings

The EDS-828 is a Layer-3 switch that performs data switching on the Network Layer (Layer 3) of the ISO's OSI layer model. Unlike Layer-2 switching, which uses the MAC address for exchanging data, a Layer-3 switch uses the IP address to represent the destination of a data packet.

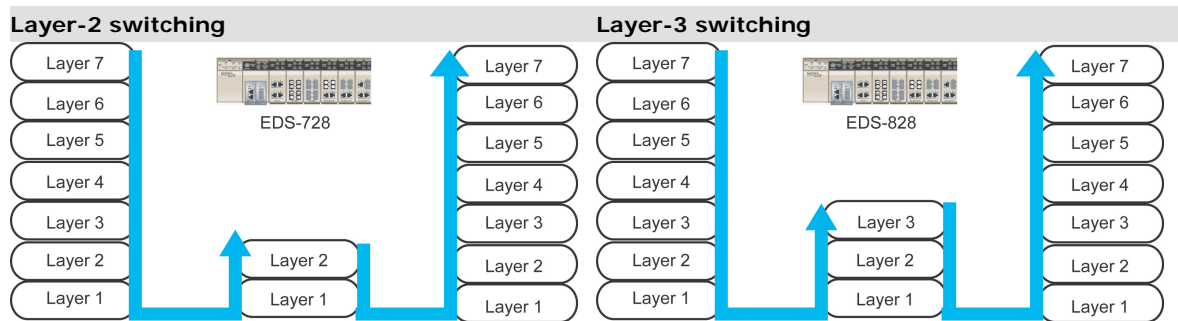

The Layer-3 Switching Concept

IP (Internet Protocol) is a protocol defined on layer 3 of the 7-layer OSI model. The IP address is used to address data packets on the Network Layer, and is not tied to the hardware of a device or PC. The IP address can be assigned by the system operator or network administrator.

Since Layer 2 switches use the MAC address to determine the destination of transmitted data packets, and Layer 3 switches use IP address, some mechanism is needed to associate MAC addresses with IP addresses. This is done by ARP (Address Resolution Protocol), which creates a table that matches MAC addresses to IP addresses.

When a PC sends out an ARP request, which is just a broadcast packet requiring the IP address owner to send back his MAC address, two situations could occur:

- If your PC and the IP address owner are on the same subnet, the IP address owner will use a unicast packet, which contains his MAC address, to reply to your PC. There after your PC will use this MAC address to transmit to the IP address owner directly.
- If your PC and the IP address owner are not on the same subnet, your PC will not receive a reply, so it will ask for the MAC address of the Layer-3 switch (gateway/ router). To transmit data packets to the IP address owner, your PC packs the data packet with the IP address, and sends the packet to the Layer-3 switch (gateway/router) using its MAC address. The Layer-3 switch (gateway/router) receives the data packet, re-packs it, and then forwards it to the next hop according to the routing rules.

Static Routing and Dynamic Routing

The EDS-828 supports two routing methods: static routing and dynamic routing. Dynamic routing makes use of RIP V1/V1c/V2, and OSPF. You can either choose one routing method, or combine the two methods to establish your routing table.

A routing entry includes the following items: the destination address, the next hop address (which is the next router along the path to the destination address), and a metric that represents the cost we have to pay to access a different network.

Static Route

You can define the routes yourself by specifying what is the next hop (or router) that the EDS-828 forwards data for a specific subnet. The settings of the Static Route will be added to the routing table and stored in the EDS-828.

RIP (Routing Information Protocol)

RIP is a distance vector-based routing protocol that can be used to automatically build up a routing table in the EDS-828.

The EDS-828 can efficiently update and maintain the routing table, and optimize the routing by identifying the smallest metric and most matched mask prefix.

Interface Setting

The IP Interface Setting page is used to assign the interface.

IP Interface Setting

IP Interface Entry

Interface Name:

IP Address:

Subnet Mask:

VLAN ID:

Proxy ARP: Enable

IP Interface Table

<input checked="" type="checkbox"/> All	Interface Name	IP Address	Subnet Mask	VLAN ID	Proxy ARP
<input type="checkbox"/>	IF_1	100.10.1.1	255.255.255.0	2	Disabled

Interface Name

Used to describe this interface (max. of 15 characters.)

IP Address

This option is used to specify the IP address of this interface.

Subnet Mask

This option is used to specify the subnet mask for this IP address.

VLAN ID

Setting	Description	Factory Default
ID numbers	Display all available VLAN IDs that you have set in the Virtual LAN. To establish an interface, you must first assign an available ID to this interface. If a VLAN ID is assigned twice, a warning message will appear.	None (if no VLAN ID is available)

Proxy ARP

Setting	Description	Factory Default
Enable/Disable	This option is used to enable or disable the Proxy ARP.	Disabled

There are three action buttons for setting up the **IP Interface Table**:

Add

To add a entry into the IP Interface Table

Delete

To remove the selected entries from the IP Interface Table

Modify

To modify the content of a selected entry in the IP Interface Table

NOTE The entries in the IP Interface Table will not be added to the EDS-828's interface table until you click the Activate button.

Static Route

The **Static Route** page is used to set up the static routing table for the EDS-828.

Static Route

Static Route Entry

Destination Address: 100.10.1.1
 Netmask: 255.255.255.0
 Next Hop: 100.10.1.254
 Metric (1~255): 10

Buttons: Add, Delete, Modify

Static Routing Table

All	Destination Address	Netmask	Next Hop	Metric
<input type="checkbox"/>	100.10.1.1	255.255.255.0	100.10.1.254	10

Activate

Static Route Entry

Destination Address

You can specify the destination's IP address.

Subnet Mask

This option is used to specify the subnet mask for this IP address.

Next Hop

This option is used to specify the next router along the path to the destination.

Metric

This option is used to specify the cost we have to pay to access the neighboring network.

Static Routing Table

There are three action buttons for setting up the **Static Routing Table**:

Add

To add an entry to the Static Routing Table

Delete

To remove the selected entries from the Static Routing Table

Modify

To modify the contents of a selected entry in the Static Routing Table

NOTE The entries in the Static Routing Table will not be added to the EDS-828's routing table until you click the Activate button.

RIP Setting

RIP is a distance-vector routing protocol that employs the hop count as a routing metric. RIP prevents routing loops by implementing a limit on the number of hops allowed in a path from the source to a destination. The RIP page is used to set up the RIP parameters.

RIP Enable

Setting	Description	Factory Default
Enable/Disable	This option is used to enable or disable the RIP function globally.	Disabled

RIP Version

You can specify which version the RIP should follow. You can also select V1 Compatibility to make sure the RIP packet of Version 1 can be received as well.

RIP Distribution

Setting	Description	Factory Default
Connected	The entries that are learned from the connected ports will be re-distributed if this option is enabled.	Unchecked (disabled)
Static	The entries that are set in a static route will be re-distributed if this option is enabled.	Unchecked (disabled)
OSPF	The entries that are learned from the OSPF will be re-distributed if this option is enabled.	Unchecked (disabled)

RIP Enable Table

This is a table showing the entries learned from RIP.

NOTE The RIP settings will not function until you click the Activate button.

OSPF Settings

OSPF (Open Shortest Path First) is a dynamic routing protocol for use in Internet Protocol (IP) networks. Specifically, it is a link-state routing protocol and falls into the group of interior gateway protocols, operating within a single autonomous system. As a link-state routing protocol, OSPF establishes and maintains neighbor relationships in order to exchange routing updates with other routers. The neighbor relationship table is called an adjacency database in OSPF. OSPF forms neighbor relationships only with the routers directly connected to it. In order to form a neighbor relationship between two routers, the interfaces used to form the relationship must be in the same area. An interface can only belong to a single area. With OSPF enabled, EDS-828 is capable to exchange routing information with other L3 switches or routers more efficiently in a large system. The OSPF Settings page is used to set up OSPF configurations.

OSPF Global Settings

Each L3 switch/router has an OSPF router ID, customarily written in the dotted decimal format (e.g., 1.2.3.4) of an IP address. This ID must be established in every OSPF instance. If not explicitly configured, the default ID (0.0.0.0) will be regarded as the router ID. Since the router ID is an IP address, it does not have to be a part of any routable subnet in the network.

OSPF State, OSPF Router ID, Current Router ID, Redistribute

Setting	Description	Factory Default
OSPF State	Select the option to enable/disable the OSPF Function.	Disable
OSPF Router ID	Set the L3 switch's Router ID.	0.0.0.0
Current Router ID	Show the current L3 switch's Router ID.	0.0.0.0
Redistribute	Redistribute routing information to other protocols	Connected

OSPF Area Settings

An OSPF domain is divided into areas that are labeled with 32-bit area identifiers which are commonly written in the dot-decimal notation of an IPv4 address. Areas are used to divide a large network into smaller network areas. They are logical groupings of hosts and networks, including their routers having interfaces connected to any of the included networks. Each area maintains a separate link state database whose information may be summarized towards the rest of the network by the connecting router. Thus, the topology of an area is unknown outside of the area. This reduces the amount of routing traffic between parts of an autonomous system.

OSPF Area Entry

Area ID, Area Type, Metric

Setting	Description	Factory Default
Area ID	Define the areas that this L3 switch/router connects to.	0.0.0.0
Area Type	Define the area type, Stub Area or NSSA.	Normal
Metric	Define the metric value.	0

OSPF Area Table

Shows the current OSPF area table in the L3 switch/router.

OSPF Interface Settings

OSPF Interface Settings

OSPF Interface Setting Entry

Interface Name:

Area ID:

Router Priority: (0 ~ 255)

Hello Interval: (1 ~ 65535)

Dead Interval: (1 ~ 65535)

Auth Type:

Auth Key: (up to 8 characters)

MD5 Key ID: (1 ~ 255)

Metric: (1 ~ 65535)

OSPF Interface Table

<input type="checkbox"/> All	Interface Name	IP Address	Area ID	State	Priority	Hello	Dead	Auth Type	Auth Key	MD5 Key ID	Metric

Before using OSPF, we have to assign an interface for each area. Also the detailed information of the interface can be defined in this section. See the details in the following descriptions:

OSPF Interface Setting Entry

Configuration details

Setting	Description	Factory Default
Interface Name	Define the interface name.	N/A
Area ID	Define the Area ID.	N/A
Router Priority	Define the L3 switch/router's priority.	1
Hello Interval	Hello packets are packets that an OSPF process sends to its OSPF neighbors to maintain connectivity with those neighbors. The hello packets are sent at a configurable interval (in seconds). The value of all hello intervals must be the same within a network.	10
Dead Interval	The dead interval is also a configurable interval (in seconds), and defaults to four times the value of the hello interval.	40
Auth Type	OSPF authentication allows the flexibility to authenticate OSPF neighbors. Users can enable authentication to exchange routing update information in a secure manner. OSPF authentication can either be none, simple, or MD5. However, authentication is not necessary to be set. If it is set, all L3 switches / routers on the same segment must have the same password and authentication method.	None

Setting	Description	Factory Default
Auth Key	Authentication key means the clear-text password when using "Simple" method of the authentication type or MD5 encrypted password when using MD5 of authentication type.	N/A
MD5 Key ID	MD5 authentication provides higher security than plain text authentication. This method uses the MD5 to calculate a hash value from the contents of the OSPF packet and the authentication key. This hash value is transmitted in the packet, along with a key ID.	1
Metric	Manually set Metric / Cost of OSPF.	1

OSPF Interface Table

Shows the current OSPF interface table in a list.

Area ID, Area Type, Metric

Setting	Description	Factory Default
Area ID	Define the areas that this L3 switch/router connects to.	0.0.0.0
Area Type	Define the area type, Stub Area or NSSA.	Normal
Metric	Define the metric value.	0

OSPF Virtual Link Settings

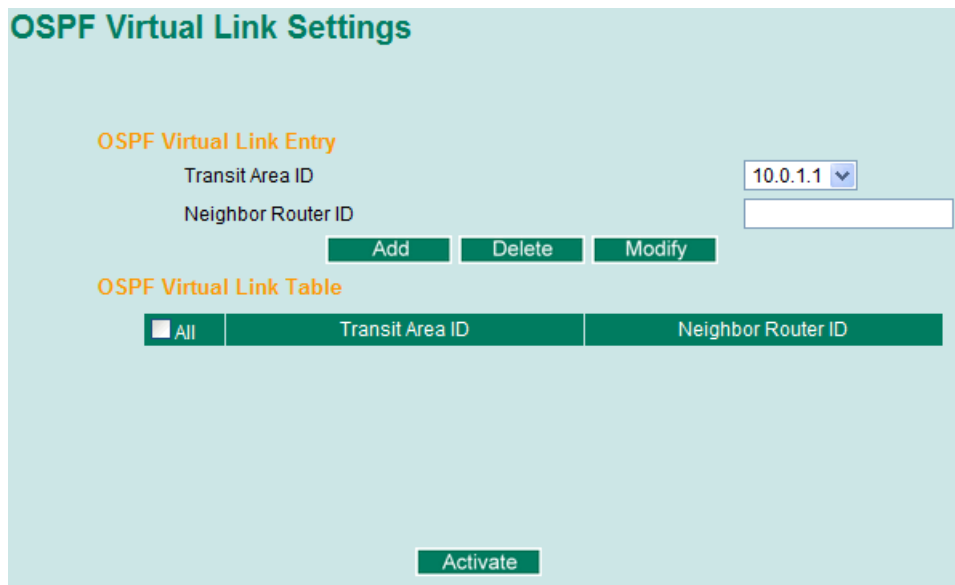

All areas in an OSPF autonomous system must be physically connected to the backbone area (Area 0.0.0.0). However, this is impossible in some cases. For those cases, users can create a virtual link to connect to the backbone through a non-backbone area and also use virtual links to connect two parts of a partitioned backbone through a non-backbone area.

OSPF Virtual Link Entry

Configuration details

Setting	Description	Factory Default
Transit Area ID	Define the areas that this L3 switch/router connects to.	N/A
Neighbor Router ID	Define the neighbor L3 switch/route's ID.	N/A

OSPF Virtual Link Table

Shows the current OSPF virtual link table.

OSPF Area Aggregation Settings

OSPF Area Aggregation Settings

OSPF Aggregation Entry

Area ID: 10.0.1.1

Network Address:

Network Mask:

OSPF Aggregation Table

All	Area ID	Network Address	Network Mask
-----	---------	-----------------	--------------

Each of OSPF areas which consist of a set of interconnected subnets and traffic across areas is handled by routers attached to two or more areas, known as Area Border Routers (ABRs). With OSPF aggregation function, users can combine groups of routes with common addresses into a single routing table entry. The function is used to reduce the size of routing tables.

OSPF Aggregation Entry

Configuration details

Setting	Description	Factory Default
Area ID	Select the Area ID that you want to configure.	N/A
Network Address	Fill in the network address in the area.	N/A
Network Mask	Fill in the network mask.	N/A

OSPF Aggregation Table

Shows the current OSPF aggregation table.

OSPF Neighbor Table

OSPF Neighbor Table

Page 1/1

Index	Neighbor ID	Priority	State	Address	Interface
-------	-------------	----------	-------	---------	-----------

Shows the current OSPF neighbor table.

OSPF Database Table

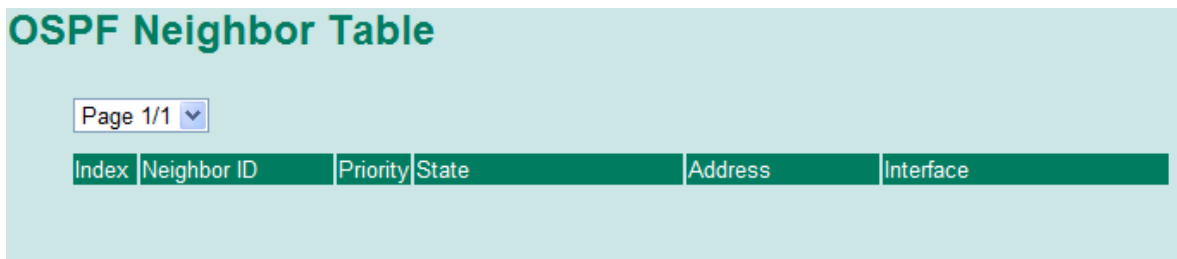

Index	Neighbor ID	Priority	State	Address	Interface
-------	-------------	----------	-------	---------	-----------

Shows the current OSPF database table.

VRRP Settings

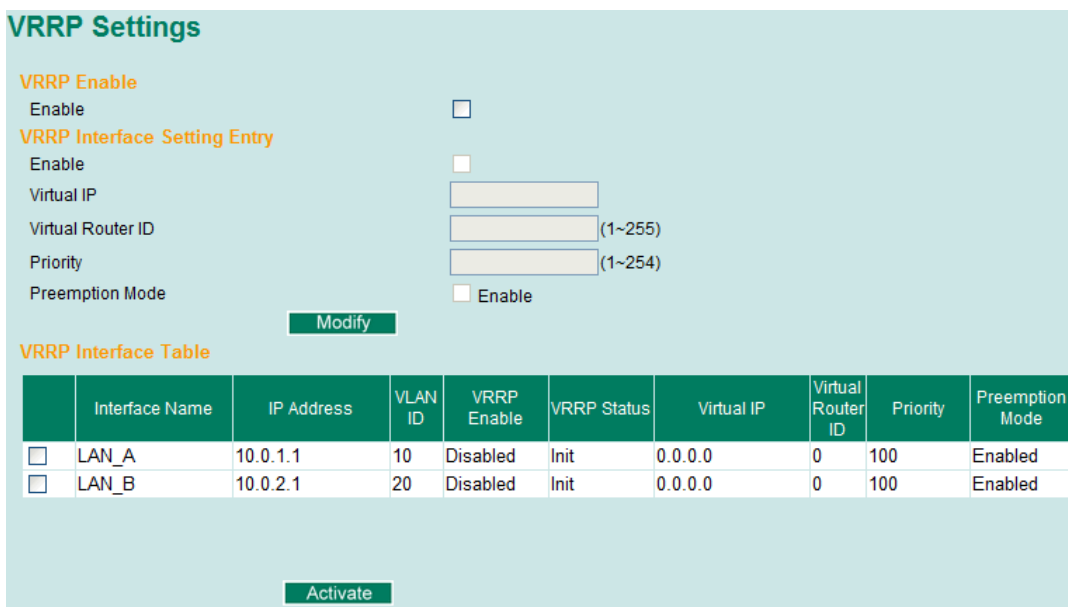

VRRP Enable

Enable

VRRP Interface Setting Entry

Enable

Virtual IP

Virtual Router ID (1~255)

Priority (1~254)

Preemption Mode Enable

VRRP Interface Table

	Interface Name	IP Address	VLAN ID	VRRP Enable	VRRP Status	Virtual IP	Virtual Router ID	Priority	Preemption Mode
<input type="checkbox"/>	LAN_A	10.0.1.1	10	Disabled	Init	0.0.0.0	0	100	Enabled
<input type="checkbox"/>	LAN_B	10.0.2.1	20	Disabled	Init	0.0.0.0	0	100	Enabled

Activate

The Virtual Router Redundancy Protocol (VRRP) feature can solve the static configuration problem. VRRP enables a group of routers to form a single virtual router with a virtual IP address. The LAN clients can then be configured with the virtual router's virtual IP address as their default gateway. The virtual router is the combination of a group of routers, and also known as a VRRP group.

Enable

Setting	Description	Factory Default
Enable	Checkmark the checkbox to enable the VRRP.	N/A

VRRP Interface Setting Entry

Setting	Description	Factory Default
Enable	Determines to enable the VRRP entry or not.	Disabled
Virtual IP	L3 switches / routers in the same VRRP group must have the identical virtual IP address like VRRP ID. This virtual IP address must belong to the same address range as the real IP address of the interface.	0.0.0.0
Virtual Router ID	Virtual Router ID is used to assign a VRRP group. The L3 switches / routers, which operate as master / backup, should have the same ID. Moxa L3 switches / routers support one virtual router ID for each interface. The usable range of ID is 1 to 255.	0

Setting	Description	Factory Default
Priority	Determines priority in a VRRP group. The priority value range is 1 to 255 and the 255 is the highest priority. If several L3 switches / routers have the same priority, the router with higher IP address has the higher priority. The usable range is "1 to 255".	100
Preemption Mode	Determines whether a backup L3 switch / router will take the authority of master or not.	Enabled

Routing Table

The **Routing Table** page shows all routing entries used by the EDS-828.

All Routing Entry List

Setting	Description	Factory Default
All	Show all routing rules	N/A
Connected	Show connected routing rules	N/A
Static	Show static routing rules	N/A
RIP	Show RIP exchanged routing rules	N/A
OSPF	Show OSPF exchanged routing rules	N/A

Using System Log

Event Log

Index	Bootup	Date	Time	System Startup Time	Event
991	36	2007/07/30	09:02:17	54d1h30m23s	Port 1 link off
992	36	2007/07/30	09:02:21	54d1h30m27s	Port 1 link on
993	36	2007/07/30	09:02:45	54d1h30m51s	Port 1 link off
994	36	2007/07/30	09:02:47	54d1h30m53s	Port 1 link on
995	36	2007/07/30	09:08:50	54d1h36m56s	Port 1 link off
996	36	2007/07/30	09:08:54	54d1h37m0s	Port 1 link on
997	36	2007/07/30	09:09:19	54d1h37m25s	Port 1 link off
998	36	2007/07/30	09:09:20	54d1h37m26s	Port 1 link on
999	36	2007/07/30	09:13:36	54d1h41m42s	192.168.2.51 admin Auth. ok
1000	36	2007/07/30	09:16:49	54d1h44m55s	192.168.2.51 admin Auth. ok

Item	Description
Bootup	This field shows how many times the EDS-828 has been rebooted or cold started.
Date	The date is updated based on how the current date is set in the "Basic Setting" page.
Time	The time is updated based on how the current time is set in the "Basic Setting" page.
System Startup Time	The system startup time related to this event.
Events	Events that have occurred.

Syslog Settings

This function provides the event logs for the syslog server. The function supports 3 configurable syslog servers and syslog server UDP port numbers. When an event occurs, the event will be sent as a syslog UDP packet to the specified syslog servers.

Syslog Server 1

Setting	Description	Factory Default
IP Address	Enter the IP address of 1st Syslog Server used by your network.	None
Port Destination (1 to 65535)	Enter the UDP port of 1st Syslog Server.	514

Syslog Server 2

Setting	Description	Factory Default
IP Address	Enter the IP address of 2nd Syslog Server used by your network.	None
Port Destination (1 to 65535)	Enter the UDP port of 2nd Syslog Server.	514

Syslog Server 3

Setting	Description	Factory Default
IP Address	Enter the IP address of 3rd Syslog Server used by your network.	None
Port Destination (1 to 65535)	Enter the UDP port of 3rd Syslog Server.	514

NOTE The following events will be recorded into the EDS-828's Event Log table, and will then be sent to the specified Syslog Server:

1. Cold start
2. Warm start
3. Configuration change activated
4. Power 1/2 transition (Off (On), Power 1/2 transition (On (Off)
5. Authentication fail
6. Topology changed
7. Master setting is mismatched
8. DI 1/2 transition (Off (On), DI 1/2 transition (On (Off)
9. Port traffic overload
10. dot1x Auth Fail
11. Port link off / on

Using HTTPS/SSL

To secure your HTTP access, the EDS-828 supports HTTPS/SSL to encrypt all HTTP traffic. Perform the following steps to access the EDS-828's web browser interface via HTTPS/SSL.

1. Open Internet Explorer and type https://EDS-828's IP address in the address field. Press Enter to establish the connection.

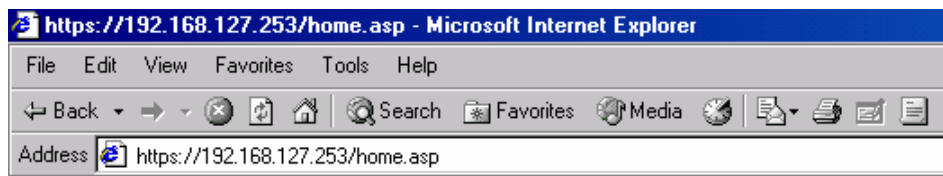

2. Warning messages will pop out to warn the user that the security certificate was issued by a company they have not chosen to trust.

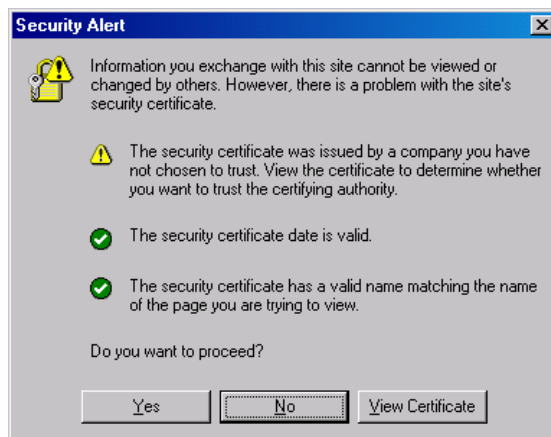

3. Select Yes to enter the EDS-828's web browser interface and access the web browser interface secured via HTTPS/SSL.



NOTE Moxa provides a Root CA certificate. After installing this certificate into your PC or Notebook, you can access the web browser interface directly and will not see any warning messages again. You may download the certificate from the EDS-828A's CD-ROM.

EDS Configurator GUI

EDS Configurator is a comprehensive Windows-based GUI that is used to configure and maintain multiple EDS switches. A suite of useful utilities is available to help you locate EDS switches attached to the same LAN as the PC host (regardless of whether or not you know the IP addresses of the switches), connect to an EDS switches whose IP address is known, modify the network configurations of one or multiple EDS switches, and update the firmware of one or more EDS switches. EDS Configurator is designed to provide you with instantaneous control of *all* of your EDS switches, regardless of location. You may download the EDS Configurator software from Moxa's website free of charge.

The following topics are covered in this chapter:

- ❑ **Starting EDS Configurator**
- ❑ **Broadcast Search**
- ❑ **Search by IP address**
- ❑ **Upgrade Firmware**
- ❑ **Modify IP Address**
- ❑ **Export Configuration**
- ❑ **Import Configuration**
- ❑ **Unlock Server**

Starting EDS Configurator

To start EDS Configurator, locate and then run the executable file **edscfgui.exe**.

NOTE You may download the EDS Configurator software from Moxa's website at www.moxa.com.

For example, if the file was placed on the Windows desktop, it should appear as follows. Simply double click on the icon to run the program.



The Moxa EtherDevice Server Configurator window will open, as shown below.

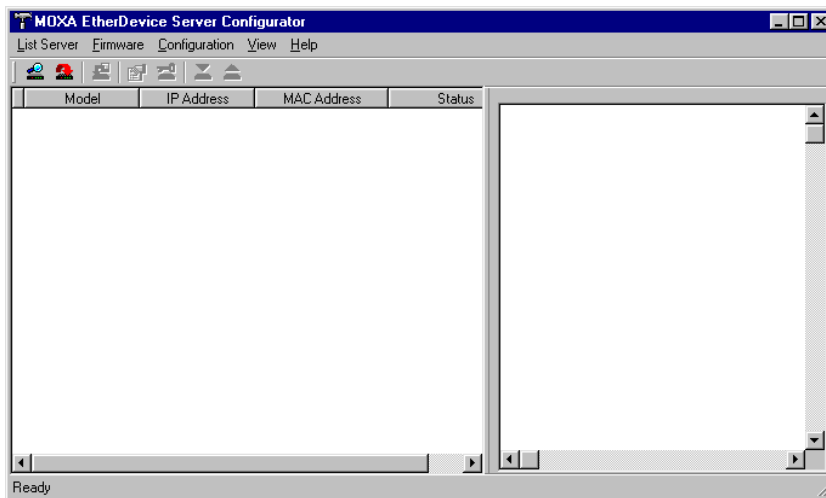

Broadcast Search

Use the Broadcast Search utility to search the LAN for all EDS switches that are connected to the LAN. Note that since the search is done by MAC address, Broadcast Search will not be able to locate Moxa EtherDevice Servers connected outside the PC host's LAN. Start by clicking on the Broadcast Search icon , or by selecting **Broadcast Search** under the **List Server** menu.

The Broadcast Search window will open, displaying a list of all switches located on the network, as well as the progress of the search.

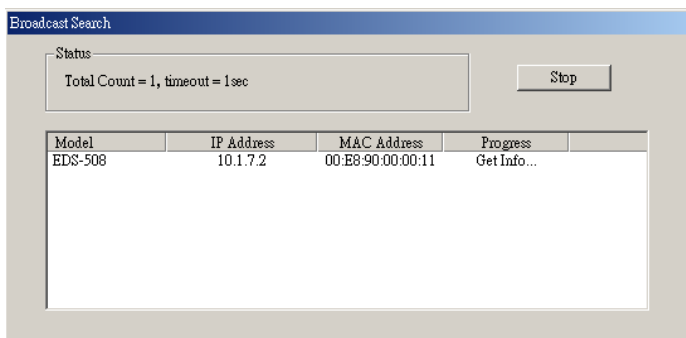

Once the search is complete, the Configurator window will display a list of all switches that were located.

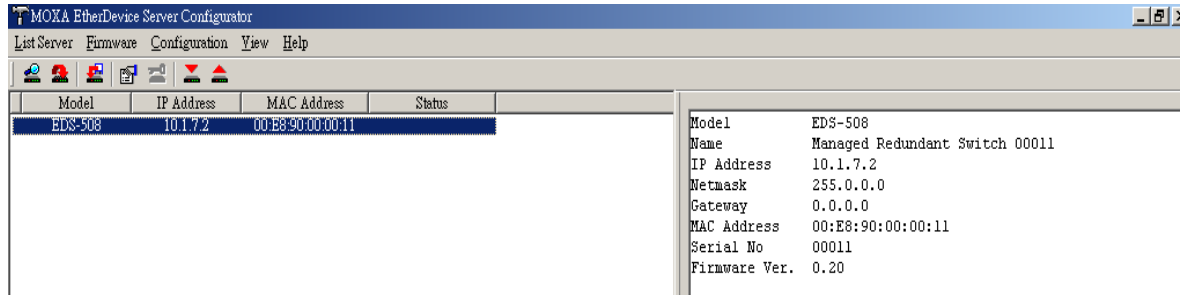

Search by IP address

This utility is used to search for one EDS switch at a time. Note that the search is conducted by IP address, so you should be able to locate any EDS switch that is properly connected to your LAN, WAN, or even the Internet.

Start by clicking on the Specify by IP address icon , or by selecting **Specify IP address** under the **List Server** menu.

The **Search Server with IP Address** window will open. Enter the IP address of the switch you wish to search for, and then click **OK**.

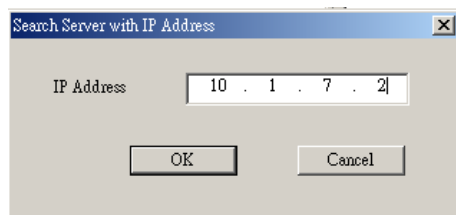

Once the search is complete, the Configurator window will add the switch to the list of switches.

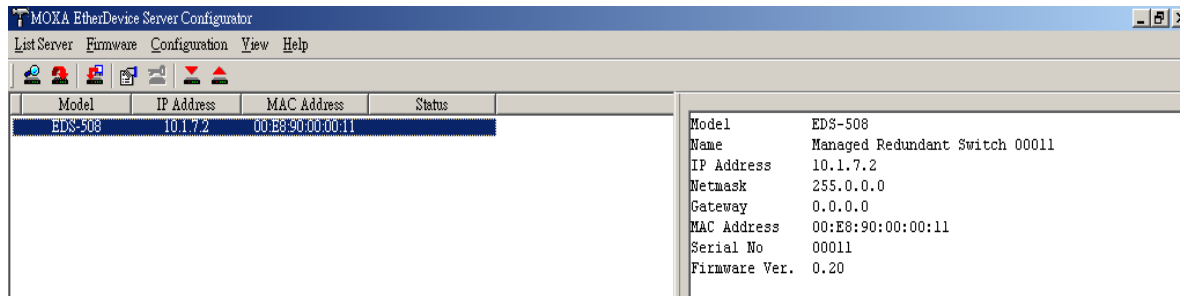

Upgrade Firmware

Keep your EDS switch up to date with the latest firmware from Moxa. Take the following steps to upgrade the firmware:

1. Download the updated firmware (*.rom) file from the Moxa website (www.moxa.com).
2. Click on the switch (from the **Moxa EtherDevice Server Configurator** window) whose firmware you wish to upgrade to highlight it.

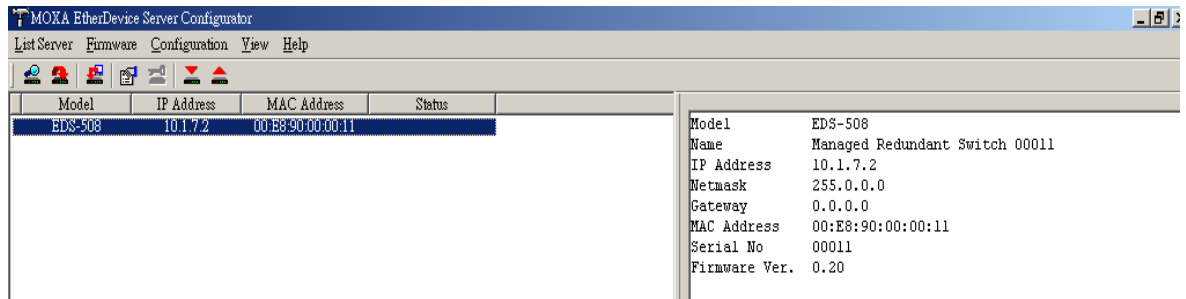

3. Click on the **Upgrade Firmware** toolbar icon , or select **Upgrade** under the **Firmware** menu. If the switch is Locked, you will be prompted to input the switch's User Name and Password.
4. Use the **Open** window to navigate to the folder that contains the firmware upgrade file, and then click on the correct "*.rom" file (**eds.rom** in the example shown below) to select the file. Click on **Open** to activate the upgrade process.

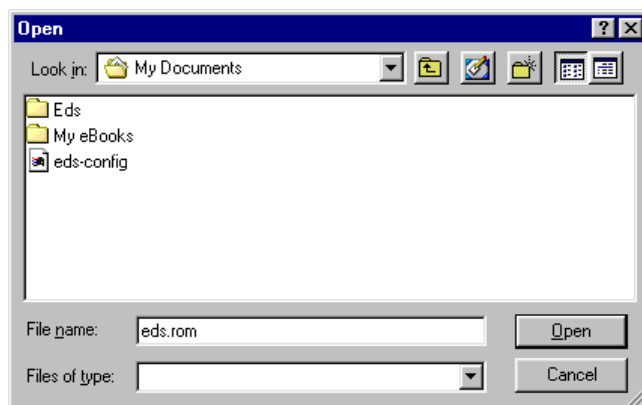

Modify IP Address

You may use the Modify IP Address function to reconfigure the EDS's network settings. Start by clicking on the Modify IP address icon , or by selecting **Modify IP address** under the **Configuration** menu.

The **Setup Configuration** window will open. Checkmark the box to the left of those items that you wish to modify, and then Disable or Enable DHCP, and enter IP Address, Subnet mask, Gateway, and DNS IP. Click **OK** to accept the changes to the configuration.

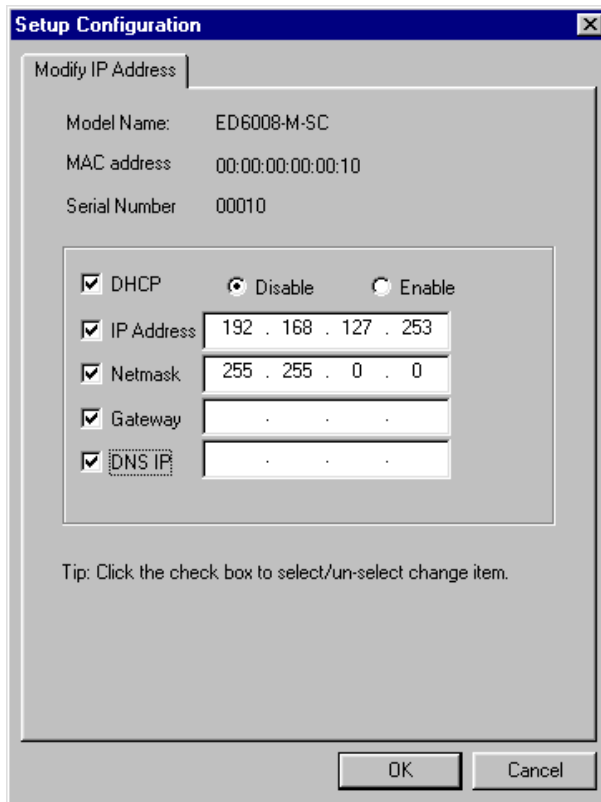

Export Configuration

The **Export Configuration** utility is used to save the entire configuration of a specified EDS switch to a text file. Take the following steps to export a configuration:

1. Highlight the switch (from the Server list in the Configurator window's left pane), and then click on the **Export** toolbar icon  or select **Export Configuration** from the **Configuration** menu. Use the **Open** window to navigate to the folder in which you want to store the configuration, and then type the name of the file in the File name input box. Click on **Open**.

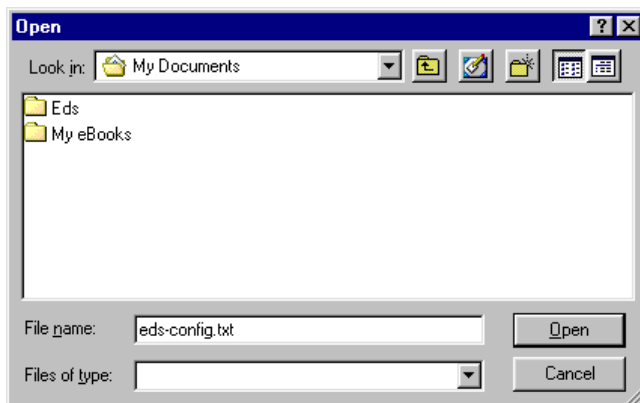

2. Click on **OK** when the **Export configuration to file OK** message appears.

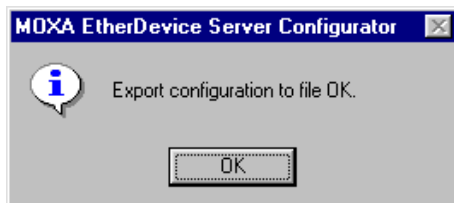

3. You may use a standard text editor, such as Notepad under Windows, to view and modify the newly created configuration file.

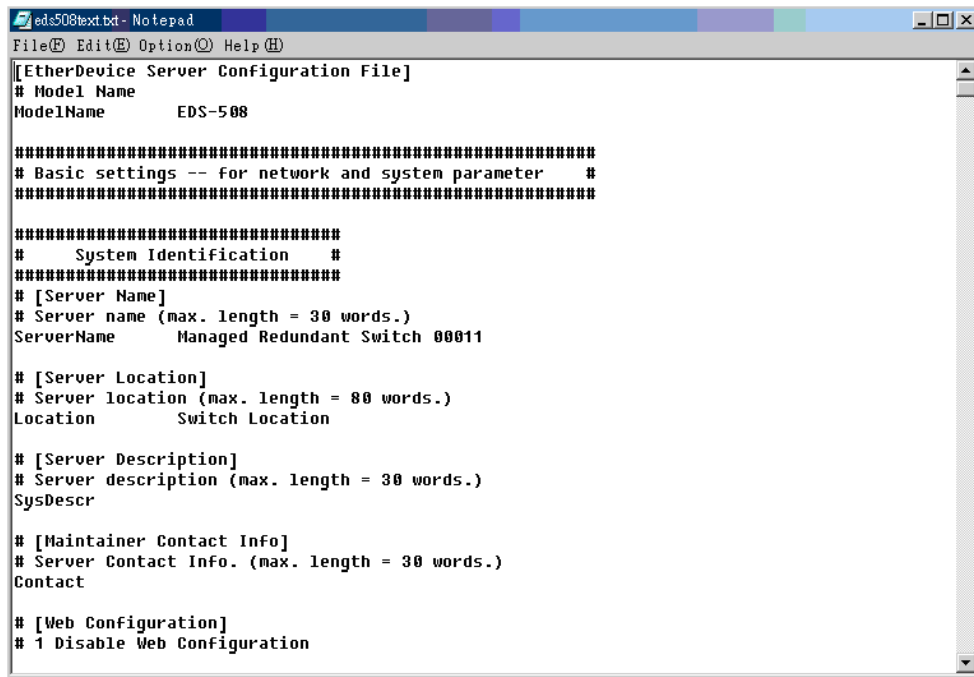

Import Configuration

The **Import Configuration** function is used to import an entire configuration from a text file to an EDS switch. This utility can be used to transfer the configuration from one EDS switch to another, by first using the Export Configuration function (described in the previous section) to save a switch configuration to a file, and then using the Import Configuration function. Take the following steps to import a configuration:

1. Highlight the server (from the Moxa EtherDevice Switch list in the Configurator window's left pane), and then click on the **Import** toolbar icon , or select **Import Configuration** from the **Configuration** menu.
2. Use the **Open** window to navigate to the text file that contains the desired configuration. Once the file is selected, click on **Open** to initiate the import procedure.

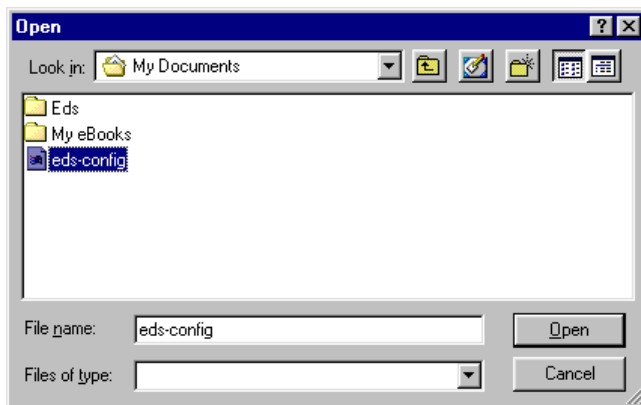

- The **Setup Configuration** window will be displayed, with a special note attached at the bottom. Parameters that have been changed will be activated with a checkmark. You may make more changes if necessary, and then click on **OK** to accept the changes.

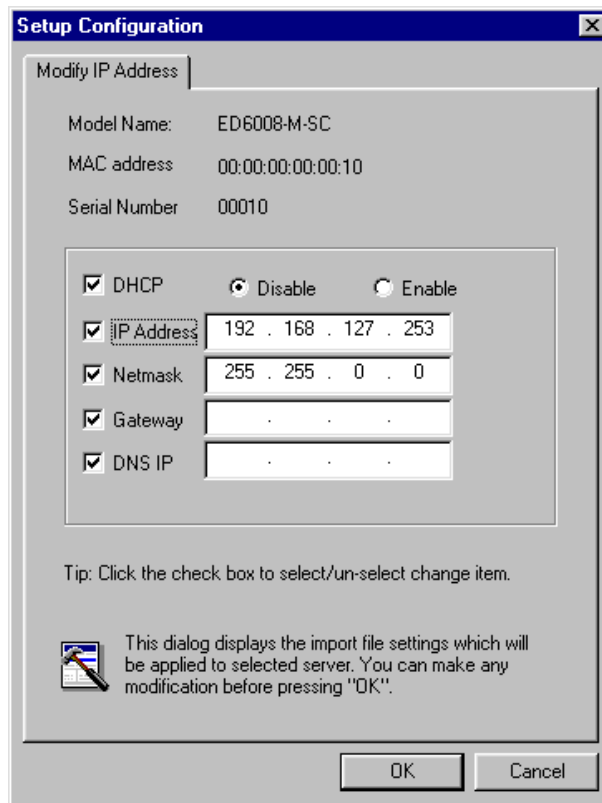

- Click on **Yes** in response to the following warning message to accept the new settings.

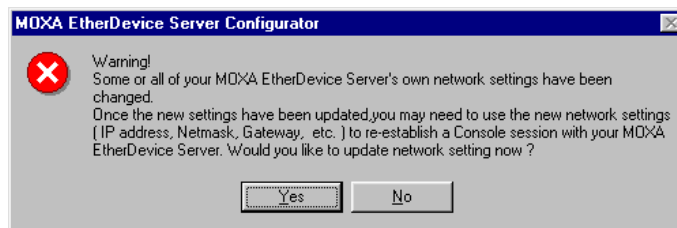

Unlock Server

The Unlock Server function is used to open a password protected switch so that the user can modify its configuration, import/export a configuration, etc. There are six possible responses under the **Status** column. The **Status** of an EDS switch indicates how the switch was located (by Moxa EtherDevice Switch Configurator), and what type of password protection it has.

The six options are as follows (note that the term **Fixed** is borrowed from the standard *fixed IP address* networking terminology):

- Locked**
 The switch is password protected, "Broadcast Search" was used to locate it, and the password has not yet been entered from within the current Configurator session.
- Unlocked**
 The switch is password protected, "Broadcast Search" was used to locate it, and the password has been entered from within the current Configurator session. Henceforth during this Configurator session, activating various utilities for this switch will not require re-entering the server password.
- Blank**
 The switch is not password protected, and "Broadcast Search" was used to locate it.

Follow the steps given below to unlock a locked EDS switch (i.e., an EDS switch with Status “Locked”). Highlight the server (from the Moxa EtherDevice Switch list in the Configurator window’s left pane), and then click on the **Unlock** toolbar icon , or select **Unlock** from the **Configuration** menu.

1. Enter the switch’s **User Name** and **Password** when prompted, and then click **OK**.

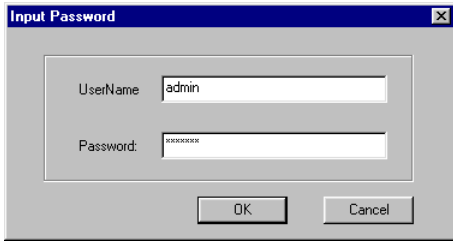

2. When the **Unlock status** window reports Progress as **OK**, click on the **Close** button in the upper right corner of the window.



3. The status of the switch will now read **Unlocked**.

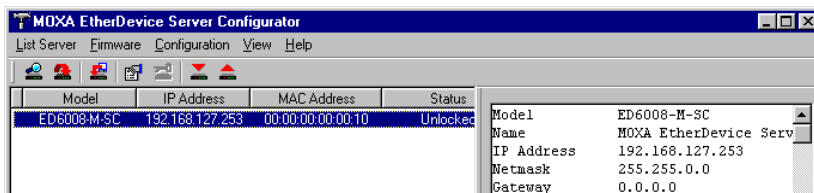

MIB Groups

The EDS-828 comes with built-in SNMP (Simple Network Management Protocol) agent software that supports cold/warm start trap, line up/down trap, and RFC 1213 MIB-II.

The standard MIB groups that the EDS-828 series support are:

MIB II.1—System Group

sysORTable

MIB II.2—Interfaces Group

ifTable

MIB II.4—IP Group

ipAddrTable
ipNetToMediaTable
IpGroup
IpBasicStatsGroup
IpStatsGroup

MIB II.5—ICMP Group

IcmpGroup
IcmpInputStatus
IcmpOutputStats

MIB II.6—TCP Group

tcpConnTable
TcpGroup
TcpStats

MIB II.7—UDP Group

udpTable
UdpStats

MIB II.10—Transmission Group

dot3
dot3StatsTable

MIB II.11—SNMP Group

SnmpBasicGroup
SnmpInputStats
SnmpOutputStats

MIB II.17—dot1dBridge Group

- dot1dBase
 - dot1dBasePortTable
- dot1dStp
 - dot1dStpPortTable
- dot1dTp
 - dot1dTpFdbTable
 - dot1dTpPortTable
 - dot1dTpHCPortTable
 - dot1dTpPortOverflowTable
- pBridgeMIB
 - dot1dExtBase
 - dot1dPriority
 - dot1dGarp
- qBridgeMIB
 - dot1qBase
 - dot1qTp
 - dot1qFdbTable
 - dot1qTpPortTable
 - dot1qTpGroupTable
 - dot1qForwardUnregisteredTable
 - dot1qStatic
 - dot1qStaticUnicastTable
 - dot1qStaticMulticastTable
 - dot1qVlan
 - dot1qVlanCurrentTable
 - dot1qVlanStaticTable
 - dot1qPortVlanTable

The EDS-828 also provides a private MIB file, located in the file "Moxa-EDS828-MIB.my" on the EDS-828 Series utility CD-ROM.

Public Traps:

1. Cold Start
2. Link Up
3. Link Down
4. Authentication Failure
5. dot1dBridge New Root
6. dot1dBridge Topology Changed

Private Traps:

1. Configuration Changed
2. Power On
3. Power Off
4. Traffic Overloaded
5. Turbo Ring Topology Changed
6. Turbo Ring Coupling Port Changed
7. Turbo Ring Master Mismatch
8. Module Inserted
9. Module Removed

B

Modbus/TCP Map

EDS-828 Modbus information v1.0

Read Only Registers (Support Function Code 4) 1 Word = 2 Bytes

Address	Data Type	Description
System Information		
0x0000	1 word	Vendor ID = 0x1393
0x0001	1 word	Unit ID (Ethernet = 1)
0x0002	1 word	Product Code = 0x0006
0x0010	20 words	Vendor Name = "Moxa" Word 0 Hi byte = 'M' Word 0 Lo byte = 'o' Word 1 Hi byte = 'x' Word 1 Lo byte = 'a' Word 2 Hi byte = '\0' Word 2 Lo byte = '\0'
0x0030	20 words	Product Name = "EDS-828" Word 0 Hi byte = 'E' Word 0 Lo byte = 'D' Word 1 Hi byte = 'S' Word 1 Lo byte = '-' Word 2 Hi byte = '8' Word 2 Lo byte = '2' Word 3 Hi byte = '8' Word 3 Lo byte = '\0' Word 4 Hi byte = '\0' Word 4 Lo byte = '\0'
0x0050	1 word	Product Serial Number
0x0051	2 words	Firmware Version Word 0 Hi byte = major (A) Word 0 Lo byte = minor (B) Word 1 Hi byte = release (C) Word 1 Lo byte = build (D)
0x0053	2 words	Firmware Release Date Firmware was released on 2007-05-06 at 09 o'clock Word 0 = 0x0609 Word 1 = 0x0705
0x0055	3 words	Ethernet MAC Address Ex: MAC = 00-01-02-03-04-05 Word 0 Hi byte = 0x00 Word 0 Lo byte = 0x01 Word 1 Hi byte = 0x02 Word 1 Lo byte = 0x03 Word 2 Hi byte = 0x04 Word 2 Lo byte = 0x05

Address	Data Type	Description
0x0058	1 word	Power 1 0x0000: Off 0x0001: On
0x0059	1 word	Power 2 0x0000: Off 0x0001: On
0x005A	1 word	Fault LED Status 0x0000: No 0x0001: Yes
0x0080	1 word	DI1 0x0000: Off 0x0001: On
0x0081	1 word	DI2 0x0000: Off 0x0001: On
0x0082	1 word	DO1 0x0000: Off 0x0001: On
0x0083	1 word	DO2 0x0000: Off 0x0001: On
Port Information		
0x1000 to 0x1011	1 word	Port 1 to 10 Status 0x0000: Link down 0x0001: Link up 0x0002: Disable 0xFFFF: No port
0x1100 to 0x1111	1 word	Port 1 to 10 Speed 0x0000: 10M-Half 0x0001: 10M-Full 0x0002: 100M-Half 0x0003: 100M-Full 0x0004: 1G-Half 0x0005: 1G- Full 0xFFFF: No port
0x1200 to 0x1211	1 word	Port 1 to 10 Flow Ctrl 0x0000: Off 0x0001: On 0xFFFF: No port
0x1300 to 0x1311	1 word	Port 1 to 10 MDI/MDIX 0x0000: MDI 0x0001: MDIX 0xFFFF: No port

Address	Data Type	Description
0x1400 to 0x1413(Port 1) 0x1414 to 0x1427(Port 2)	20 words	Port 1 to 10 Description Port Description = "100TX,RJ45." Word 0 Hi byte = '1' Word 0 Lo byte = '0' Word 1 Hi byte = '0' Word 1 Lo byte = 'T' ... Word 4 Hi byte = '4' Word 4 Lo byte = '5' Word 5 Hi byte = '.' Word 5 Lo byte = '\0'
Packet Information		
0x2000 to 0x2023	2 words	Port 1 to 10 Tx Packets Ex: port 1 Tx Packets = 0x44332211 Word 0 = 4433 Word 1 = 2211
0x2100 to 0x2123	2 words	Port 1 to 10 Rx Packets Ex: port 1 Rx Packets = 0x44332211 Word 0 = 4433 Word 1 = 2211
0x2200 to 0x2223	2 words	port 1 to 10 Tx Error Packets Ex: port 1 Tx Error Packets = 0x44332211 Word 0 = 4433 Word 1 = 2211
0x2300 to 0x2323	2 words	port 1 to 10 Rx Error Packets Ex: port 1 Rx Error Packets = 0x44332211 Word 0 = 4433 Word 1 = 2211
Redundancy Information		
0x3000	1 word	Redundancy Protocol 0x0000: None 0x0001: RSTP 0x0002: Turbo Ring 0x0003: Turbo Ring V2 0x0004: Turbo Chain
0x3100	1 word	RSTP Root 0x0000: Not Root 0x0001: Root 0xFFFF: RSTP Not Enable
0x3200 to 0x3211	1 word	RSTP Port 1 to 10 Status 0x0000: Port Disabled 0x0001: Not RSTP Port 0x0002: Link Down 0x0003: Blocked 0x0004: Learning 0x0005: Forwarding 0xFFFF: RSTP Not Enable
0x3300	1 word	TR Master/Slave 0x0000: Slave 0x0001: Master 0xFFFF: Turbo Ring Not Enable

Address	Data Type	Description
0x3301	1 word	TR 1st Port status 0x0000: Port Disabled 0x0001: Not Redundant 0x0002: Link Down 0x0003: Blocked 0x0004: Learning 0x0005: Forwarding
0x3302	1 word	TR 2nd Port status 0x0000: Port Disabled 0x0001: Not Redundant 0x0002: Link Down 0x0003: Blocked 0x0004: Learning 0x0005: Forwarding
0x3303	1 word	TR Coupling 0x0000: Off 0x0001: On 0xFFFF: Turbo Ring Not Enable
0x3304	1 word	TR Coupling Port status 0x0000: Port Disabled 0x0001: Not Coupling Port 0x0002: Link Down 0x0003: Blocked 0x0005: Forwarding 0xFFFF: Turbo Ring Not Enable
0x3305	1 word	TR Coupling Control Port status 0x0000: Port Disabled 0x0001: Not Coupling Port 0x0002: Link Down 0x0003: Blocked 0x0005: Forwarding 0x0006: Inactive 0x0007: Active 0xFFFF: Turbo Ring Not Enable
0x3500	1 word	TR2 Coupling Mode 0x0000: None 0x0001: Dual Homing 0x0002: Coupling Backup 0x0003: Coupling Primary 0xFFFF: Turbo Ring V2 Not Enable
0x3501	1 word	TR2 Coupling Port Primary status (Using in Dual Homing, Coupling Backup, Coupling Primary) 0x0000: Port Disabled 0x0001: Not Coupling Port 0x0002: Link Down 0x0003: Blocked 0x0004: Learning 0x0005: Forwarding 0xFFFF: Turbo Ring V2 Not Enable

Address	Data Type	Description
0x3502	1 word	TR2 Coupling Port Backup status (Only using in Dual Homing) 0x0000:Port Disabled 0x0001:Not Coupling Port 0x0002:Link Down 0x0003:Blocked 0x0004:Learning 0x0005:Forwarding 0xFFFF:Turbo Ring V2 Not Enable
0x3600	1 word	TR2 Ring 1 status 0x0000:Healthy 0x0001:Break 0xFFFF:Turbo Ring V2 Not Enable
0x3601	1 word	TR2 Ring 1 Master/Slave 0x0000:Slave 0x0001:Master 0xFFFF:Turbo Ring V2 Ring 1 Not Enable
0x3602	1 word	TR2 Ring 1 1st Port status 0x0000:Port Disabled 0x0001:Not Redundant 0x0002:Link Down 0x0003:Blocked 0x0004:Learning 0x0005:Forwarding 0xFFFF:Turbo Ring V2 Ring 1 Not Enable
0x3603	1 word	TR2 Ring 1 2nd Port status 0x0000:Port Disabled 0x0001:Not Redundant 0x0002:Link Down 0x0003:Blocked 0x0004:Learning 0x0005:Forwarding 0xFFFF:Turbo Ring V2 Ring 1 Not Enable
0x3680	1 word	TR2 Ring 2 status 0x0000:Healthy 0x0001:Break 0xFFFF:Turbo Ring V2 Ring 2 Not Enable
0x3681	1 word	TR2 Ring 2 Master/Slave 0x0000:Slave 0x0001:Master 0xFFFF:Turbo Ring V2 Ring 2 Not Enable
0x3682	1 word	TR2 Ring 2 1st Port status 0x0000:Port Disabled 0x0001:Not Redundant 0x0002:Link Down 0x0003:Blocked 0x0004:Learning 0x0005:Forwarding 0xFFFF:Turbo Ring V2 Ring 2 Not Enable

Address	Data Type	Description
0x3683	1 word	TR2 Ring 2 2nd Port status 0x0000: Port Disabled 0x0001: Not Redundant 0x0002: Link Down 0x0003: Blocked 0x0004: Learning 0x0005: Forwarding 0xFFFF: Turbo Ring V2 Ring 2 Not Enable
0x3700	1 word	Turbo Chain Switch Role 0x0000: Head 0x0001: Member 0x0002: Tail 0xFFFF: Turbo Chain Not Enable
0x3701	1 word	Turbo Chain 1st Port status 0x0000: Link Down 0x0001: Blocking 0x0002: Blocked 0x0003: Forwarding 0xFFFF: Turbo Ring V2 Ring 2 Not Enable
0x3702	1 word	Turbo Chain 2nd Port status 0x0000: Link Down 0x0001: Blocking 0x0002: Blocked 0x0003: Forwarding 0xFFFF: Turbo Ring V2 Ring 2 Not Enable