



# IA240-LX

## Quick Installation Guide

Fourth Edition, January 2014

### 1. Overview

The IA240 embedded computer comes with four RS-232/422/485 serial ports, a 4-ch digital input, a 4-ch digital output, dual 10/100 Mbps Ethernet ports, an SD socket interface for storage expansion, and a USB 2.0 host port, making the IA240 ideal for your embedded applications.

### 2. Package Checklist

Before installing the IA240, verify that the package contains the following items:

- 1 IA240 or IA241 embedded computer
- Wall-Mounting Kit
- DIN-Rail Mounting Kit (attached to the product casing)
- IA240/241 Quick Installation Guide (this guide)
- IA240/241 Document & Software CD
- Cross-over Ethernet cable
- CBL-RJ45M9-150: 150 cm, 8-pin RJ45 to DB9 (M) serial port cable
- CBL-RJ45F9-150: 150 cm, 8-pin RJ45 to DB9 (F) console port cable
- Universal Power Adaptor
- Product Warranty Statement

*NOTE: Notify your sales representative if any of the above items are missing or damaged.*

### 3. IA240 Panel Layout

The IA240 comes with four RS-232/422/485 serial ports, one RS-232 console port, dual 10/100 Mbps LAN ports, one SD socket, a 4-ch DI, and a 4-ch DO. The following figures show the panel layouts of the IA240.

#### Top View

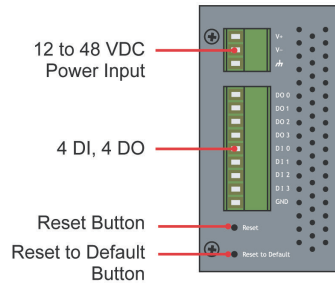

#### Front View

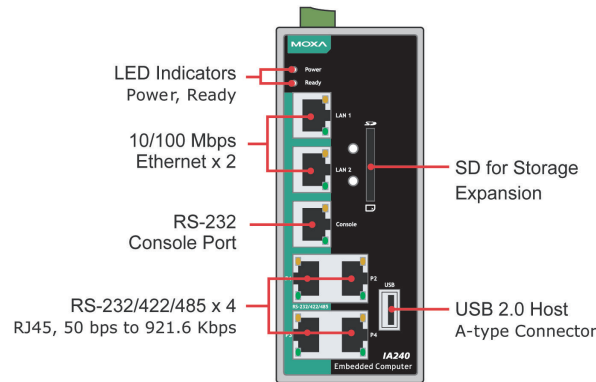

#### Rear View

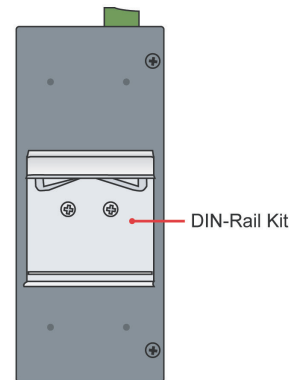

#### LED Indicators

The following table describes the LED indicators located on the front panel of the IA240.

LED Name	LED Color	LED Function
Power	Red	Power is on
Ready	Green	OS is ready and functioning normally
LAN 1/2	Orange	10 Mbps Ethernet connection
	Green	100 Mbps Ethernet connection
Console	Orange	Console port is receiving RX data
	Green	Console port is transmitting TX data
P1/P2/P3/P4	Orange	Serial port 1/2/3/4 is receiving data
	Green	Serial port 1/2/3/4 is transmitting data

### 4. Installing the IA240

#### Wall or Cabinet Mounting

The IA240 comes with two metal brackets for attaching it to a wall or the inside of a cabinet. Using two screws per bracket, first attach the brackets to the rear of the IA240. Next, use two screws per bracket to attach the IA240 to a wall or cabinet.

#### DIN-Rail Mounting

The aluminum DIN-Rail attachment plate is already attached to the product casing. When attaching the plate to the IA240, make sure that the stiff metal spring is at the top.

**STEP 1:** Insert the top of the DIN-Rail into the slot just below the stiff metal spring.

**STEP 2:** The DIN-Rail attachment unit will snap into place as shown below.

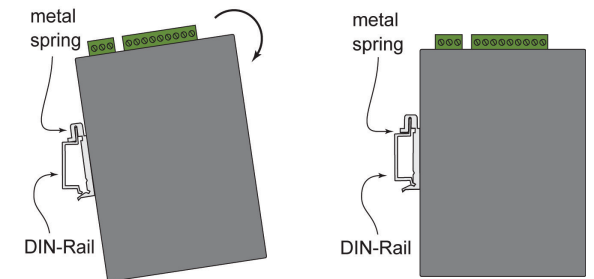

To remove the IA240 from the DIN-Rail, simply reverse Steps 1 and 2 above.

### 5. Connector Description

#### Power Connector

Connect the 12 to 48 VDC power line to the IA240's terminal block. If the power is properly supplied, the Power LED will light up. The OS is ready when the Ready LED glows a solid green.

#### Grounding the IA240

Grounding and wire routing help limit the effects of noise due to electromagnetic interference (EMI). Run the ground connection

from the ground screw to the grounding surface prior to connecting the power.

## ATTENTION

This product is intended to be mounted to a well-grounded mounting surface, such as a metal panel.

**SG:** The Shielded Ground (sometimes called Protected Ground) contact is the bottom contact of the 3-pin power terminal block connector when viewed from the angle shown here. Connect the SG wire to an appropriate grounded metal surface.

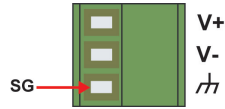

## Ethernet Ports

The two 10/100 Mbps Ethernet ports (LAN 1 and LAN 2) use RJ45 connectors.

Pin	Signal
1	ETx+
2	ETx-
3	ERx+
6	ERx-

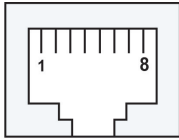

## Serial Ports

The four serial ports (P1 to P4) use RJ45 connectors. Each port can be configured by software for RS-232, RS-422, or RS-485. The pin assignments for the ports are shown in the following table:

Pin	RS-232	RS-422	RS-485
1	DSR	---	---
2	RTS	TXD+	---
3	GND	GND	GND
4	TXD	TXD-	---
5	RXD	RXD+	Data+
6	DCD	RXD-	Data-
7	CTS	---	---
8	DTR	---	---

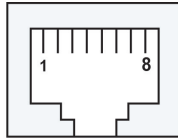

## DI, DO

The four Digital Input channels and four Digital Output channels use separate terminal blocks.



## SD Interface

The IA240 comes with an SD socket for storage expansion. Moxa provides an SD flash disk for plug & play expansion. The disk allows users to plug in a Secure Digital (SD) memory card compliant with the SD 1.0 standard for up to 1 GB of additional memory space, or a Secure Digital High Capacity (SDHC) memory

card compliant with the SD 2.0 standard for up to 16 GB of additional memory space. The SD socket is located at the front side of the IA240. To install an SD card, you must first remove the SD protection cover to access the socket, and then plug the SD card into the socket directly. Remember to push in on the SD card first if you want to remove the card.

The SD card will be mounted at `/mnt/sd`.

## Console Port

The console port is an RJ45 RS-232 port. It is designed for serial console, and can be connected to a V90 or GPRS modem via PPP. The pin definitions are the same as for the four serial ports (P1 to P4).

## Reset to default Button

Press the "Reset to Default" button continuously for at least 5 seconds to load the factory default configuration. After the factory default configuration has been loaded, the system will reboot automatically. The Ready LED will blink on and off for the first 5 seconds, and then maintain a steady glow once the system has rebooted.

## Reset Button

Press the "Reset" button to activate the hardware reset function. You should only use this function if the software does not function properly. To reset a Linux system, you should reboot the operating system to avoid deleting important data.

## USB

The USB 2.0 Host port now supports a USB storage device driver. The USB storage will be mounted at `/mnt/usbstorage`.

## Real Time Clock

The IA240's real time clock is powered by a lithium battery. We strongly recommend that you do not replace the lithium battery without help from a qualified Moxa support engineer. If you need to change the battery, contact the Moxa RMA service team.

## ATTENTION

There is a risk of explosion if the battery is replaced by an incorrect type of battery.

## 6. Powering on the IA240

To power on the IA240, connect the "terminal block to power jack converter" to the IA240's DC terminal block (located on the left rear panel), and then connect the power adaptor. Note that the Shielded Ground wire should be connected to the right most pin of the terminal block. It takes about 30 seconds for the system to boot up. Once the system is ready, the Ready LED will light up.

## 7. Connecting the IA240 to a PC

There are two ways to connect the IA240 to a PC: (1) through the serial console port, or (2) by Telnet over the network. The COM

settings for the serial console port are: **Baudrate=115200 bps, Parity=None, Data bits=8, Stop bits =1, Flow Control=None.**

## ATTENTION

Remember to choose the "VT100" terminal type. Use the CBL-RJ45F9-150 cable included with the product to connect a PC to the IA240's serial console port.

To use Telnet, you will need to know the IA240's IP address and netmask. The default LAN settings are shown below. For first-time configuration, you may find it convenient to use a cross-over Ethernet cable to connect directly from the PC to the IA240.

	Default IP Address	Netmask
LAN 1	192.168.3.127	255.255.255.0
LAN 2	192.168.4.127	255.255.255.0

Once the IA240 is powered on, the Ready LED will light up, and a login page will open. Use the following default Login name and Password to proceed. The defaults are:

**Login: root**

**Password: root**

## 8. Configuring the Ethernet Interface

If you use the console cable for first-time configuration of the Network settings, use the following commands to edit the **interfaces** file:

```
#ifdown -a
//Disable LAN1/LAN2 interface first, before you
reconfigure the LAN settings. LAN 1 = ixp0, LAN 2 =
ixp1//
#vi /etc/network/interfaces
//check the LAN interface first//
```

After the boot setting of the LAN interface has been modified, use the following commands to activate the LAN settings immediately:

```
#sync ; ifup -a
```

**NOTE** Refer to the IA240 User's Manual for other configuration information.

**MOXA** [www.moxa.com/support](http://www.moxa.com/support)

The Americas: +1-714-528-6777 (toll-free: 1-888-669-2872)  
 Europe: +49-89-3 70 03 99-0  
 Asia-Pacific: +886-2-8919-1230  
 China: +86-21-5258-9955 (toll-free: 800-820-5036)

© 2014 Moxa Inc. All rights reserved.