

# EDS-728/828

## Quick Installation Guide

---

Moxa EtherDevice Switch

Edition 4.0, February 2017

### Technical Support Contact Information

[www.moxa.com/support](http://www.moxa.com/support)

Moxa Americas:

Toll-free: 1-888-669-2872

Tel: 1-714-528-6777

Fax: 1-714-528-6778

Moxa China (Shanghai office):

Toll-free: 800-820-5036

Tel: +86-21-5258-9955

Fax: +86-21-5258-5505

Moxa Europe:

Tel: +49-89-3 70 03 99-0

Fax: +49-89-3 70 03 99-99

Moxa Asia-Pacific:

Tel: +886-2-8919-1230

Fax: +886-2-8919-1231

Moxa India:

Tel: +91-80-4172-9088

Fax: +91-80-4132-1045

**MOXA®**

© 2017 Moxa Inc. All rights reserved.

P/N: 1802008280013



## EDS-728/828 Series Panel Layout

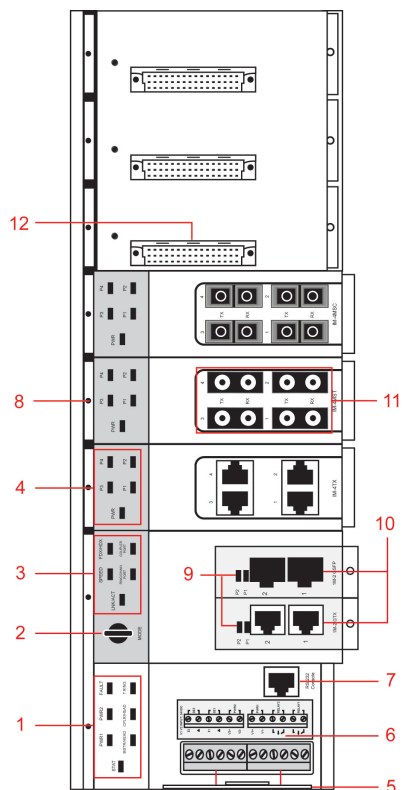

1. System status LEDs
2. Push-button switch to select mode for Interface Module
3. Interface Module mode LEDs
4. Fast Ethernet Interface Module port LEDs
5. Terminal block for 2 power inputs, 2 DI, and 2 DO
6. Sticker showing pin contacts
7. Serial console port
8. Screw to attach Fast Ethernet Interface Module
9. Gigabit Ethernet Module LEDs
10. Two cartridge receptors for Gigabit Ethernet Interface Modules
11. Fast Ethernet Interface Modules
12. Sockets for Fast Ethernet Interface Modules

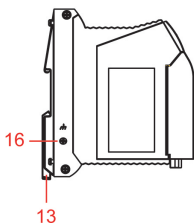
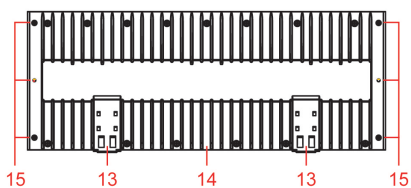

## Mounting Dimensions (unit = mm)

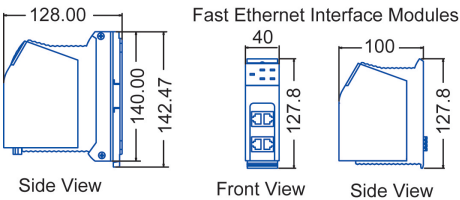
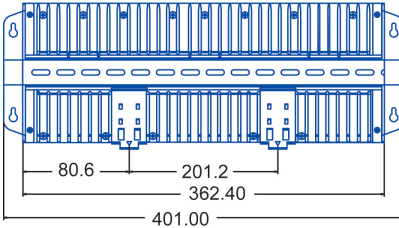
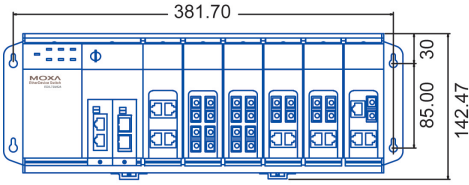

### Gigabit Ethernet Interface Modules

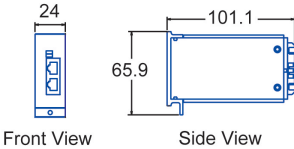

## DIN-Rail Mounting

The DIN-Rail attachment plates are permanently fixed to the back panel of the EDS-728/828. Do not attempt to remove the attachment plates, since doing so could damage the product.

### To Install:

Lock the brace by pressing the clips and then insert the top of the DIN-Rail into the notches at the bottom of the top array of heat radiating ribs. Press the EDS until the brace snaps into place.

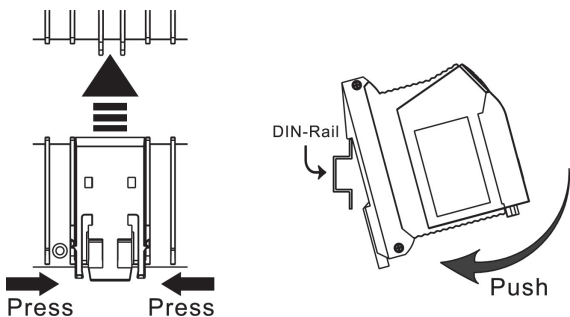

### **To Release:**

Use a flat-blade screw driver as a lever to force the braces downwards, and then pull the EDS-728/828 out away from the DIN-Rail.

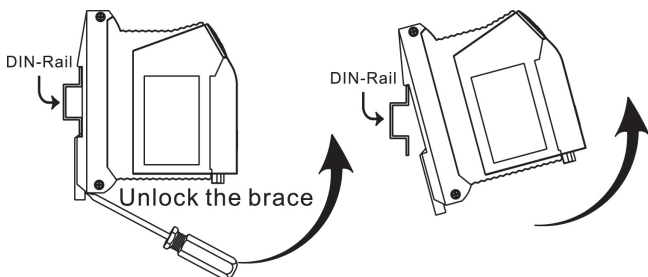

### **Wall Mounting (optional)**

For some applications, you will find it convenient to mount the EDS-728/828 on the wall, as illustrated below.

**STEP 1:** Remove the aluminum DIN-Rail attachment plate from the EDS-728/828's rear panel, and then attach the wall mounting plates, as shown in the diagram.

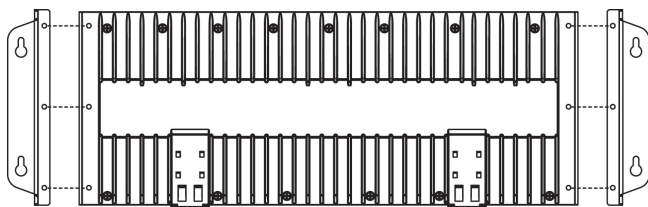

**STEP 2:** Mounting the EDS-728/828 on the wall requires 4 screws to ensure that the switch does not come loose from the wall. Use the switch, with wall mounting plates attached, as a guide to mark the correct locations of the 4 screws. The heads of the screws should be less than 6.0 mm in diameter, and the shafts should be less than 3.5 mm in diameter, as shown in the figure at the right.

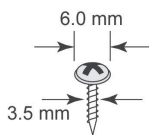

**NOTE** Before tightening the screws into the wall, make sure the screw head and shank size are suitable by inserting the screw into one of the keyhole-shaped apertures of the Wall Mounting Plates.

Do not screw the screws in all the way—leave about 2 mm to allow room for sliding the wall mount panel between the wall and the screws.

**STEP 3:** Once the screws are fixed in the wall, insert the four screw heads through the large parts of the keyhole-shaped apertures, and then slide Moxa EDS downwards, as indicated. Tighten the four screws for added stability.

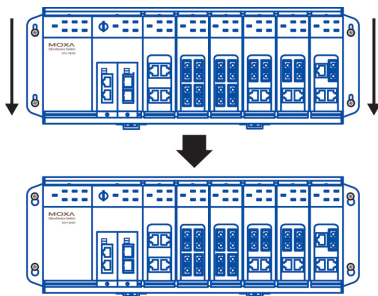

## Uninstalling IM-2G Modules

As shown in the figure below, use a flat-blade screw driver as a lever, and pull or push it to force the IM-2G module outwards. Then pull the module out away from the EDS-728/828.

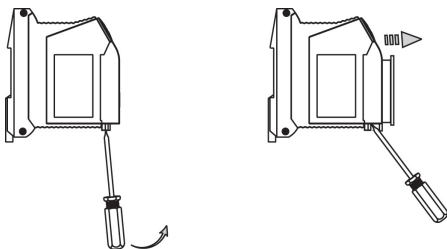

## Wiring Requirements



### WARNING

#### Safety First!

Be sure to disconnect the power cord before installing and/or wiring your Moxa EDS-728/828.

Calculate the maximum possible current in each power wire and common wire. Observe all electrical codes dictating the maximum current allowable for each wire size.

If the current goes above the maximum ratings, the wiring could overheat, causing serious damage to your equipment.

You should also pay attention to the following guidelines:

- Use separate paths to route wiring for power and devices. If power wiring and device wiring paths must cross, make sure the wires are perpendicular at the intersection point.  
**NOTE:** Do not run signal or communications wiring and power wiring in the same wire conduit. To avoid interference, wires with different signal characteristics should be routed separately.
- You can use the type of signal transmitted through a wire to determine which wires should be kept separate. The rule of thumb is that wiring that shares similar electrical characteristics can be bundled together.
- Keep input wiring and output wiring separated.
- It is strongly advised that you label wiring to all devices in the system when necessary.

## Grounding Moxa EtherDevice Switch

Grounding and wire routing help limit the effects of noise due to electromagnetic interference (EMI). Run the ground connection from the ground screw, on the side panel of the EDS-728/828, to the grounding surface prior to connecting devices.



### ATTENTION

This product is intended to be mounted to a well-grounded mounting surface, such as a metal panel.

## Wiring the Relay Contact

In this section, we explain the meaning of the two contacts used to connect the alarm contact.

The EDS-728/828 has two sets of relay output—relay 1 and relay 2. Each relay contact consists of the two contacts of the terminal block on the EDS-728/828's top panel. Refer to the next section for detailed instructions on how to connect the wires to the terminal block connector, and how to attach the terminal block connector to the terminal block receptor.

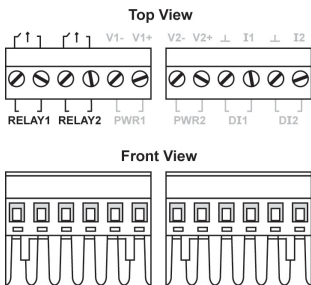

**FAULT:** The two sets of relay contacts of the 6-pin terminal block connector are used to detect user-configured events. The two wires attached to the Fault contacts form an open circuit when a user-configured event is triggered. If a user-configured event does not occur, the Fault circuit will be closed.

## Wiring the Redundant Power Inputs

The EDS-728/828 has two sets of power input—power input 1 and power input 2. The top two contacts and the bottom two contacts of the 6-pin terminal block connector on EDS's top panel are used for EDS's two digital inputs.

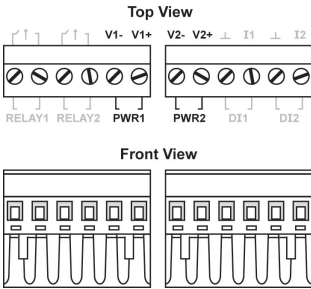

**STEP 1:** Insert the negative/positive DC wires into the V-/V+ terminals.

**STEP 2:** To keep the DC wires from pulling loose, use a small flat-blade screwdriver to tighten the wire-clamp screws on the front of the terminal block connector.

**STEP 3:** Insert the plastic terminal block connector prongs into the terminal block receptor, which is located on the EDS-728/828's top panel.

## Wiring the Digital Inputs

The EDS-728/828 has two sets of digital input—DI 1 and DI 2. Each DI comprises two contacts of the 6-pin terminal block connector on EDS's top panel. The terminal block is also used for EDS's two DC inputs. Top and front views of one of the terminal block connectors are shown here.

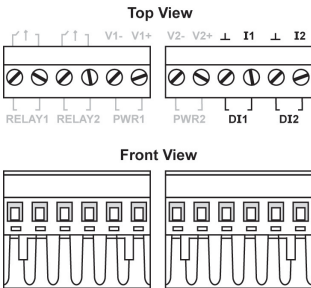

**STEP 1:** Insert the negative (ground)/ positive DI wires into the  $\pm$ /I1 terminals.

**STEP 2:** To keep the DI wires from pulling loose, use a small flat-blade screwdriver to tighten the wire-clamp screws on the front of the terminal block connector.

**STEP 3:** Insert the plastic terminal block connector prongs into the terminal block receptor, which is located on the EDS-728/828's top panel.

## Communication Connections

The pinout and cable wiring diagrams in this section show how the ports on the EDS-728/828 connect to other devices:

**Pinouts** are diagrams that indicate the type of signal passing through each of the port's pins.

### RS-232 Connection

The EDS-728/828 has one RS-232 (10-pin RJ45) console port, located on the front panel. Use either an RJ45-to-DB9 or RJ45-to-DB25 cable to connect the Moxa EDS-728/828's console port to your PC's COM port. You may then use console terminal software, such as Moxa PComm Terminal Emulator, to access the Moxa EDS-728/828's console configuration utility. (Baudrate: 115200 bps, no parity, 8 data bit, 1 stop bit)

## 10-pin RJ45 Console Pinouts

10-Pin	Description
1	–
2	DSR
3	–
4	GND
5	TxD
6	RxD
7	GND
8	–
9	DTR
10	–

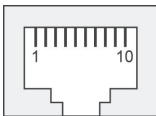

## 10/100BaseT(X) Ethernet Port Connection

Below we show pinouts for both MDI (NIC-type) ports and MDI-X (HUB/Switch-type) ports.

### MDI Port Pinouts

Pin	Signal
1	Tx+
2	Tx-
3	Rx+
6	Rx-

### MDI-X Port Pinouts

Pin	Signal
1	Rx+
2	Rx-
3	Tx+
6	Tx-

### 8-pin RJ45

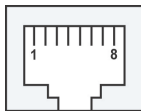

## 1000BaseT Ethernet Port Connection

1000BaseT data is transmitted on differential TRD+/- signal pairs over copper wires.

### MDI/MDI-X Port Pinouts

Pin	MDI	MDI-X
1	BI_DA+	BI_DB+
2	BI_DA-	BI_DB-
3	BI_DB+	BI_DA+
4	BI_DC+	BI_DD+
5	BI_DC-	BI_DD-
6	BI_DB-	BI_DA-
7	BI_DD+	BI_DC+
8	BI_DD-	BI_DC-

### 8-pin RJ45

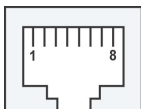

## 100/1000Base Fiber Port Connection

The concept behind the duplex port and cable is quite straightforward. Suppose you are connecting devices I and II. Contrary to electrical signals, optical signals do not require a circuit in order to transmit data. Consequently, one of the optical lines is used to transmit data from device I to device II, and the other optical line is used to transmit data from device II to device I, for full-duplex transmission.

All you need to remember is to connect the Tx (transmit) port of device I to the Rx (receive) port of device II, and the Rx (receive) port of device I to the Tx (transmit) port of device II. If you make your own cable, we suggest labeling the two sides of the same line with the same letter (A-to-A and B-to-B or A1-to-A2 and B1-to-B2).





## ATTENTION

This is a Class 1 Laser/LED product. To avoid causing serious damage to your eyes, do not stare directly into the Laser Beam.

## LED Indicators

LED	Color	State	Description
<b>System LEDs</b>			
STAT	GREEN	On	System has passed self-diagnosis test on boot-up and is ready to run.
		Blinking	System is undergoing the self-diagnosis test.
	RED	On	System failed self-diagnosis on boot-up.
PWR1	AMBER	On	Power is being supplied to the main module's power input PWR1.
		Off	Power is not being supplied to the main module's power input PWR1.
PWR2	AMBER	On	Power is being supplied to the main module's power input PWR2.
		Off	Power is not being supplied to the main module's power input PWR2.
FAULT	RED	On	The corresponding PORT alarm is enabled and a user-configured event has been triggered.
		Off	The corresponding PORT alarm is enabled and a user-configured event has not been triggered, or the corresponding PORT alarm is disabled.
MSTR/ HEAD	GREEN	On	This EDS-728/828 is the Master of this Turbo Ring, or the Head of this Turbo Chain.
		Blinking	This EDS-728/828 has become the Master of this Turbo Ring, or the Head of this Turbo Chain, after the Turbo Ring or Turbo Chain was broken.
		Off	This EDS-728/828 is not the Master of this Turbo Ring or is set as a Member of the Turbo Chain.
CPLR/ TAIL	GREEN	On	This EDS-728/828 enabled the coupling function to form a back-up path, or it is the Tail of this Turbo Chain.
		Blinking	When the Turbo Chain is down.
		Off	When this EDS-728/828 disables the coupling function, or is set as a Member of the Turbo Chain.
T.RING	GREEN	Off	This EDS-728/828 does not belong to an active Turbo Ring or a Turbo Chain
		On	This EDS-728/828 belongs to an active Turbo Ring or a Turbo Chain

**NOTE** Use the Mode push-button switch to cycle among the LNK/ACT, SPEED, FDX/HDX, RING PORT, and COUPLER PORT LEDs. The status of these five settings is indicated by the LEDs for the various ports.

LED	Color	State	Description
<b>Mode LEDs</b>			
LNK/ ACT	GREEN	On	The corresponding module port's link is active.
		Blinking	The corresponding module port's data is being transmitted.
		Off	The corresponding module port's link is inactive.
FDX/ HDX	GREEN	On	The corresponding module port's data is being transmitted at full duplex.
		Off	The corresponding module port's data is not being transmitted.
RING/ CHAIN PORT	GREEN	On	The corresponding module's port is the ring port or chain port of this EDS-728/828.
		Off	The corresponding module's port is not the ring port or chain port of this EDS-728/828.
COUPL ER	GREEN	On	The corresponding module's port is the coupler port of this EDS-728/828.
		Off	The corresponding module's port is not the coupler port of this EDS-728/828.
SPEED	GREEN	Off	The corresponding module port's data is being transmitted at 10 Mbps.
		On	The corresponding module port's data is being transmitted at 100 Mbps.
		Blinking	The corresponding module port's data is being transmitted at 1000 Mbps.
<b>Fast Ethernet Module LEDs</b>			
PWR	GREEN	On	Power is being supplied to the interface module.
		Off	Power is not being supplied to the interface module.
P1/P2/ P3/P4	GREEN	On/ Off/ Blinking	Displays the module port's status by mode.
<b>Gigabit Ethernet Module LED</b>			
P1/P2	GREEN	On/ Off/ Blinking	Displays the module port's status by mode.

## Specifications

### Modular Managed Switch System, EDS-72810G/82810G

Modular Managed Switch System with 6 slots, and up to 28 ports.

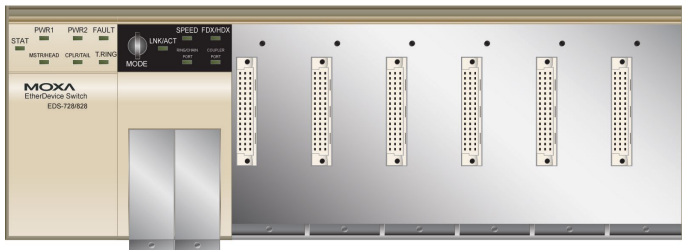

Technology	
Standards	IEEE802.3, 802.3u, 802.3x, 802.1D, 802.1w, 802.1Q, 802.1p, 802.1X, 802.3ad, 802.3z
Protocols	EDS-728/828: IGMPv1/v2, GMRP, GVRP, SNMPv1/v2c/v3, DHCP Server/Client, BootP, TFTP, SNTp, SMTP, RARP, RMON, HTTP, HTTPS, Telnet, Syslog, DHCP Option 66/67/82, SSH, SNMP Inform, Modbus TCP, LLDP, IEEE 1588 PTP, IPv6 EDS-828: RIP V1/V2, OSPF, VRRP
MIB	MIB-II, Ethernet-Like MIB, P-BRIDGE MIB, Q-BRIDGE MIB, Bridge MIB, RSTP MIB, RMON MIB Groups 1, 2, 3, 9
Flow Control	IEEE802.3x flow control/back pressure
Interface	
Fast Ethernet	6 slots for any combination of 4-port Interface Modules with 10/100BaseT(X) or 100BaseFX
Gigabit Ethernet	2 sockets for any combination of 2-port Interface Modules with 10/100/1000BaseT(X), and 1000BaseSX/LX/LHX/ZX SFP modules
Console	RS-232 (RJ45)
System LED Indicators	STAT, PWR1, PWR2, FAULT, MASTER, COUPLER, T.RING
Module LED Indicators	LNK/ACT, FDX/HDX, RING PORT, COUPLER, PORT, SPEED
Alarm Contact	Two relay outputs with current carrying capacity of 1 A @ 24 VDC
Digital Inputs	Two inputs with the same ground, but electrically isolated from the electronics. <ul style="list-style-type: none"> <li>• For state "1": +13 to +30V</li> <li>• For state "0": -30 to +3V</li> <li>• Max. input current: 8 mA</li> </ul>

Power	
Input Voltage	24 VDC (12 to 45 VDC), redundant dual inputs
Connection	Two removable 6-pin terminal blocks
Power Consumption	EDS-72810G/82810G 22.9 W IM-4TX 2.5 W IM-2MSC/2TX 5 W IM-2MST/2TX 5 W IM-2SSC/2TX 5 W IM-4MSC 7.2 W IM-4MST 7.2 W IM-4SSC 7.2 W IM-1LSC/3TX 4 W IM-2GTX 3 W IM-2GSFP 3 W
Overload Current Protection	Present
Reverse Polarity Protection	Present
Mechanical	
Casing	IP30 protection
Dimensions	362 x 146 x 128 mm (W x H x D)
Weight	1850 g
Installation	DIN-Rail, Wall Mounting (optional kit)

## Gigabit Ethernet Interface Module, IM-2G Series

**IM-2GTX:** Interface Module with 2 10/100/1000BaseT(X) ports, RJ45 connectors.

**IM-2GSFP:** Interface Module with 2 1000BaseSX/LX/LHX/ZX SFP sockets for SFP modules.

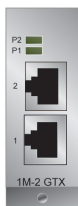

**IM-2GTX**

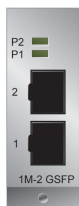

**IM-2GSFP**

Interface	
LED Indicators	P1, P2 for Port Status
RJ45 Ports	10/100/1000BaseT(X) auto negotiation speed, and auto MDI/MDI-X connection
Distance	100 m
Fiber Ports	1000BaseSX/LX/LHX/ZX (SFP socket)

## Optical Fiber/SFP-1GxxxLC Series

### SFP Modules:

	SX	LX	LHX	ZX
Wavelength	850 nm	1310 nm	1310 nm	1310 nm
Max. Tx	-4 dBm	-3 dBm	1 dBm	+5 dBm
Min. Tx	-9.5 dBm	-9.5 dBm	-4 dBm	0 dBm
Rx Sensitivity	-18 dBm	-20 dBm	-24 dBm	-24 dBm
Link Budget	8.5 dB	10.5 dB	20 dB	24 dB
Typical Distance	550 m <sup>a</sup> 275 m <sup>b</sup>	1100 m <sup>c</sup> 550 m <sup>d</sup> 10 km <sup>e</sup>	40 km <sup>e</sup>	80 km <sup>f</sup>
Saturation	0 dBm	-3 dBm	-3 dBm	-3 dBm

- a. [50/125 μm, 400 MHz\*km] cable  
 b. [62.5/125 μm, 200 MHz\*km] cable  
 c. [50/125 μm, 800 MHz\*km] cable  
 d. [62.5/125 μm, 500 MHz\*km] cable  
 e. [9/125 μm, 3.5 PS/(nm\*km)] cable  
 f. [9/125 μm, 19 PS/(nm\*km)] cable

### WDM-type (BiDi) SFP Modules:

	10A	10B	20A	20B	40A	40B
Wavelength (nm)	TX: 1310 RX: 1550	TX: 1550 RX: 1310	TX: 1310 RX: 1550	TX: 1550 RX: 1310	TX: 1310 RX: 1550	TX: 1550 RX: 1310
Max. Tx	-3 dBm	-3 dBm	-2 dBm	-2 dBm	+2 dBm	+2 dBm
Min. Tx	-9 dBm	-9 dBm	-8 dBm	-8 dBm	-3 dBm	-3 dBm
Rx Sensitivity	-21 dBm	-21 dBm	-23 dBm	-23 dBm	-23 dBm	-23 dBm
Link Budget	12 dB	12 dB	15 dB	15 dB	20 dB	20 dB
Typical Distance	10 km	10 km	20 km	20 km	40 km	40 km
Saturation	-1 dBm	-1 dBm	-1 dBm	-1 dBm	-1 dBm	-1 dBm

### Mechanical

Dimensions	24 x 66 x 101 mm (W x H x D)
Weight	IM-2GTX 150 g IM-2GSFP 148 g

## Fast Ethernet Interface Module, IM Series

**IM-4TX:** Interface Module with 4 10/100BaseT(X) ports, RJ45 connectors.

**IM-4MSC:** Interface Module with 4 multi-mode 100BaseFX ports, SC connectors.

**IM-4MST:** Interface Module with 4 multi-mode 100BaseFX ports, ST connectors.

**IM-4SSC:** Interface Module with 4 single mode 100BaseFX ports, 40 km SC connectors.

**IM-2MSC/2TX:** Interface Module with 2 multi-mode 100BaseFX ports, SC connectors, and 2 10/100BaseT(X) ports, RJ45 connectors.

**IM-2MST/2TX:** Interface Module with 2 multi-mode 100BaseFX ports, ST connectors, and 2 10/100BaseT(X) ports, RJ45 connectors.

**IM-2SSC/2TX:** Interface Module with 2 single mode 100BaseFX ports, 40 km SC connectors, and 2 10/100BaseT(X) ports, RJ45 connectors.

**IM-1LSC/3TX:** Interface Module with 1 single mode 100BaseFX port, 80 km SC connector and 3 10/100BaseT(X) ports, RJ45 connectors.

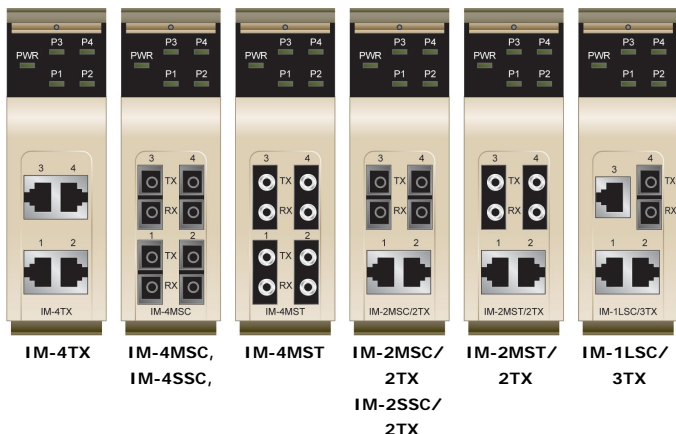

Interface			
LED Indicators	PWR, P1, P2, P3, P4 port status		
RJ45 Ports	10/100/1000BaseT(X) auto negotiation speed, F/H duplex mode, and auto MDI/MDI-X connection		
Distance	100 m		
Fiber Ports	100BaseFX ports (SC/ST connector)		
Optical Fiber:			
	Multi-mode	Single mode	Single mode, 80 km
Wavelength	1300 nm	1310 nm	1550 nm
Max. Tx	-10 dBm	0 dBm	0 dBm
Min. Tx	-20 dBm	-5 dBm	-5 dBm
Rx Sensitivity	-32 dBm	-34 dBm	-34 dBm
Link Budget	12 dB	29 dB	29 dB
Typical Distance	5 kma 4 kmb	40 kmc	80 kmd
Saturation	-6 dBm	-3 dBm	-3 dBm
a. using [50/125 μm, 800 MHz*km] cable b. using [62.5/125 μm, 500 MHz*km] cable c. using [9/125 μm, 3.5 PS/(nm*km)] cable d. using [9/125 μm, 19 PS/(nm*km)] cable			
Mechanical			
Casing	IP30 protection		
Dimensions	40 x 130 x 100 mm (W x H x D)		
Weight	IM-4TX	215 g	
	IM-2MSC/2TX	245 g	
	IM-2MST/2TX	250 g	
	IM-2SSC/2TX	245 g	
	IM-1LSC/3TX	235 g	
	IM-4MSC	250 g	
	IM-4MST	270 g	
	IM-4SSC	270 g	

<b>Environmental</b>	
Operating Temperature	0 to 60°C (32 to 140°F)
Storage Temperature	-40 to 85°C (-40 to 185°F)
Ambient Relative Humidity	5 to 95% (non-condensing)
<b>Regulatory Approvals</b>	
Safety	UL 508, UL 60950-1, CSA C22.2 No. 60950-1, EN 60950-1
Hazardous Location	UL/cUL Class I, Division 2, Groups A, B, C and D (Pending) ATEX Class I, Zone 2, EEx nC IIC (Pending)
EMI	FCC Part 15, CISPR (EN 55032) class A
EMS	EN 61000-4-2 (ESD), Level 3 EN 61000-4-3 (RS), Level 3 EN 61000-4-4 (EFT), Level 4 EN 61000-4-5 (Surge), DC Input: level 4; Comm. Line: level 3 EN 61000-4-6 (CS), Level 3 EN 61000-4-8 EN 61000-4-11 EN 61000-4-12
Shock	IEC 60068-2-27
Freefall	IEC 60068-2-32
Vibration	IEC 60068-2-6
<b>WARRANTY</b>	5 years