

SPL-24 Series Quick Installation Guide

PoE Splitter

Version 6.1, February 2021

Technical Support Contact Information

www.moxa.com/support

MOXA[®]

© 2021 Moxa Inc. All rights reserved.

P/N: 1802000240110



Overview

The **SPL-24** plays the role of PD, and splits the data signal and power signal that are transmitted from the PSE. The SPL-24 plays a dual role of providing power to industrial devices, and enabling Ethernet connections.

The SPL-24 have a wide operating temperature range of -40 to 75°C, and are designed to withstand a high degree of vibration and shock. The rugged hardware design makes the SPL-24 perfect for ensuring that your Ethernet equipment can operate in critical industrial environments, such as in hazardous locations, and complies with FCC and CE standards.

NOTE Throughout this Hardware Installation Guide, we use EDS as an abbreviation for Moxa EtherDevice Switch, and we use SPL as an abbreviation for Moxa PoE Splitter:

SPL = Moxa PoE Splitter

Wiring Requirements



WARNING

Do not disconnect modules or wires unless the power supply has been switched off or the area is known to be non-hazardous. The devices may only be connected to the supply voltage shown on the type plate. The devices are designed for operation with a Safety Extra-Low Voltage. Thus, they may only be connected to the supply voltage connections and to the signal contact with the Safety Extra-Low Voltages (SELV) in compliance with IEC 60950-1/EN 60950-1.



WARNING

The power for this product is intended to be supplied by a Listed Power Unit, with output marked LPS, and rated to deliver 48 VDC at a maximum of 300 mA.



WARNING

This unit is a built-in type. When the unit is installed in another piece of equipment, the equipment enclosing the unit must comply with fire enclosure regulation IEC 60950-1/EN60950-1 (or similar regulation).



WARNING

Safety First!

Be sure to disconnect the power cord before installing and/or wiring your Moxa EtherDevice Switch. Calculate the maximum possible current in each power wire and common wire. Observe all electrical codes dictating the maximum current allowable for each wire size. If the current goes above the maximum ratings, the wiring could overheat, causing serious damage to your equipment.

You should also pay attention to the following items:

- Use separate paths to route wiring for power and devices. If power wiring and device wiring paths must cross, make sure the wires are perpendicular at the intersection point.
NOTE: Do not run signal or communications wiring and power wiring in the same wire conduit. To avoid interference, wires with different signal characteristics should be routed separately.
- You can use the type of signal transmitted through a wire to determine which wires should be kept separate. The rule of thumb is that wiring that shares similar electrical characteristics can be bundled together.
- Keep the input wiring and the output wiring separated.
- It is strongly advised that you label the wiring to all devices in the system when necessary.

Package Checklist for SPL-24

The Moxa SPL-24 is shipped with the following items. If any of these items is missing or damaged, please contact your customer service representative for assistance.

- Moxa PoE Splitter, SPL-24
- Quick installation guide (printed)
- Warranty card

Features of SPL-24

High Performance Network Switching Technology

- IEEE802.3af compliance
- Power/data split from PoE lines using either spare-pairs or data pairs
- Support for up to 12.95 W at 24 VDC
- Support for up to 15.4 watts per PoE port
- Short circuit protection
- Auto disconnection for over voltage or under voltage
- Power consumption detection and classification

Rugged Design

- Operating temperature range from 0 to 60°C, or extended operating temperature from -40 to 75°C for "-T" models
- IP30, plastic case
- DIN-Rail or panel mounting ability

Specifications of SPL-24

Technology	
Standards	IEEE802.3af
Interface	
RJ45 Ports	10/100BaseT(X) for PoE IN, and 10/100BaseT(X) for DATA OUT
LED Indicators	Power
Power	
Input voltage	44 to 56 VDC
Output voltage	24 VDC
Output current	0.54 A @ 24V
Output Power	12.95 W (@ 24 VDC)
Connection	Removable "3-pin" Terminal Block for output
Overload current Protection	400 mA (@ 48 VDC input)
Efficiency	85% (at 25°C, full-loaded)
Mechanical	
Casing	IP30 protection, plastic case
Dimensions	25 × 109 × 88 mm (W × H × D)
Weight	95 g
Installation	DIN-Rail, Wall Mounting
Environmental	
Operating Temperature	0 to 60°C (32 to 140°F) -40 to 75°C (-40 to 167°F) for -T models
Storage Temperature	-40 to 85°C (-40 to 185°F)
Ambient Relative Humidity	5 to 95% (non-condensing)
Regulatory Approvals	
Safety	Pending: UL60950, UL 508, CSA C22.2 No. 60950, EN60950 (pending)
Hazardous Location	UL/cUL Class I, Division 2, Groups A, B, C and D (pending) ATEX Class I, Zone 2, EEx nC IIC (pending)
EMI	FCC Part 15, CISPR 32 class A
EMS	EN61000-4-2 (ESD), Level 3 EN61000-4-3 (RS), Level 3 EN61000-4-4 (EFT), Level 3 EN61000-4-5 (Surge), Level 3 EN61000-4-6 (CS), Level 3
Shock	IEC60068-2-27
Freefall	IEC60068-2-32
Vibration	IEC60068-2-6
WARRANTY	5 years

SPL-24 Panel Layout

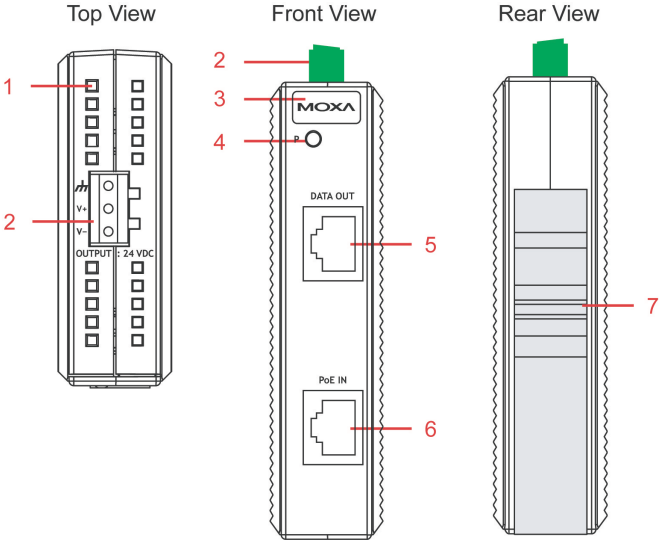

1. Heat dissipation orifices
2. Terminal block for power input and grounding
3. Moxa Logo
4. PoE power LED
5. DATA-OUT port
6. PoE IN port
7. DIN-Rail

Mounting Dimensions

Unit = mm (inch)

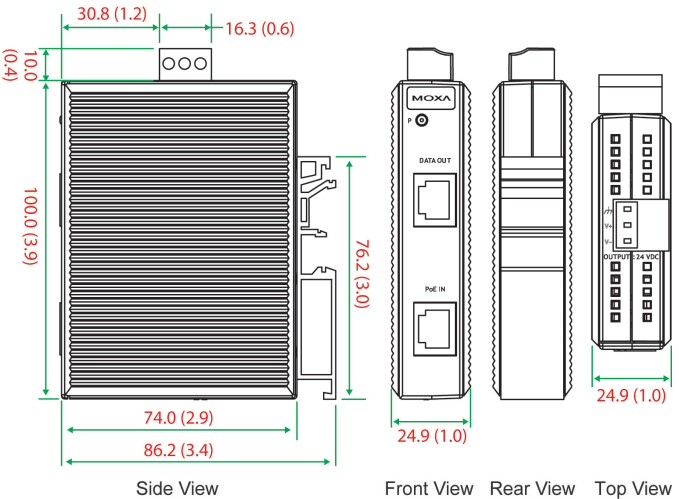

DIN-Rail Mounting for SPL-24

The plastic DIN-Rail attachment plate should already be fixed to the back panel of SPL-24 when you take it out of the box. If you need to reattach the DIN-Rail attachment plate, make sure the stiff metal spring is situated towards the top, as shown in the figures below.

STEP 1:

Insert the top of the DIN-Rail into the slot.

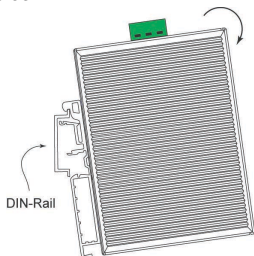

STEP 2:

The DIN-Rail attachment unit will snap into place as shown below.

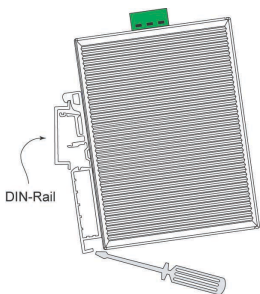
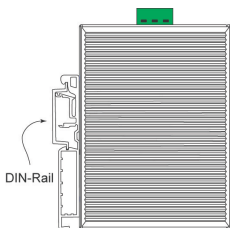

To remove the SPL-24 from the DIN-Rail, insert a flat-blade screw driver horizontally into the DIN-Rail kit under the SPL-24, and then pull it upwards and release SPL-24 towards you away from the DIN-Rail.

Grounding the SPL-24

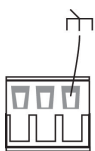

Top View

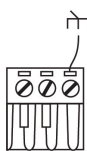

Front View

Grounding and wire routing help limit the effects of noise due to electromagnetic interference (EMI). Run the right most contact of the 3-contact terminal block to the grounding surface prior to connecting devices.



ATTENTION

This product is intended to be mounted to a well-grounded mounting surface, such as a metal panel.

Wiring the SPL-24's Power Outputs

The two left-most contacts of the 3-contact terminal block connector on the SPL-24's top panel are used for 24 VDC output. Top and front views of one of the terminal block connectors are shown here.

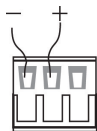

Top View

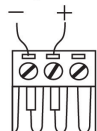

Front View

STEP 1:

Insert the negative/positive DC wires into the V-/V+ terminals.

STEP 2:

To keep the DC wires from pulling loose, use a small flat-blade screwdriver to tighten the wire-clamp screws on the front of the terminal block connector.

STEP 3:

Insert the plastic terminal block connector prongs into the terminal block receptor, which is located on SPL-24's top panel.

Patent http://www.moxa.com/doc/operations/Moxa_Patent_Marking.pdf