

V3200 Series Hardware User Manual

Version 1.2, October 2024

www.moxa.com/products

MOXA®

© 2024 Moxa Inc. All rights reserved.

V3200 Series Hardware User Manual

The software described in this manual is furnished under a license agreement and may be used only in accordance with the terms of that agreement.

Copyright Notice

© 2024 Moxa Inc. All rights reserved.

Trademarks

The MOXA logo is a registered trademark of Moxa Inc.
All other trademarks or registered marks in this manual belong to their respective manufacturers.

Disclaimer

- Information in this document is subject to change without notice and does not represent a commitment on the part of Moxa.
- Moxa provides this document as is, without warranty of any kind, either expressed or implied, including, but not limited to, its particular purpose. Moxa reserves the right to make improvements and/or changes to this manual, or to the products and/or the programs described in this manual, at any time.
- Information provided in this manual is intended to be accurate and reliable. However, Moxa assumes no responsibility for its use, or for any infringements on the rights of third parties that may result from its use.
- This product might include unintentional technical or typographical errors. Changes are periodically made to the information herein to correct such errors, and these changes are incorporated into new editions of the publication.

Technical Support Contact Information

www.moxa.com/support

Table of Contents

1. Introduction	5
Overview	5
Package Checklist	5
Product Features	6
Hardware Specifications	6
Hardware Block Diagram	6
2. Hardware Introduction	7
Appearance	7
Front View	7
Rear View	8
Dimensions	9
V3200-TL-8L Models	9
V3200-TL-4L Models	10
LED Indicators	11
Real-time Clock	11
3. Hardware Connection Description	12
Installing the V3200	12
Wall or Cabinet Mounting	12
Wiring Requirements	13
Connecting the Power	14
Grounding the Unit	15
Connecting Data Transmission Cables	15
Connecting to the Network	15
Connecting to a Serial Device	17
Digital Inputs/Outputs	18
Connecting the Displays	19
Connecting to the USB Ports	20
Installing the Storage Drive	20
Installing the SIM Cards	23
Installing the Wireless Modules	25
Installing the 4G/Wi-Fi 5 Module	27
Installing the Wi-Fi 6 Module	28
Installing Wireless Cables and Antennas	29
Switching the Wireless Module Socket	31
Replacing the Battery	32
4. BIOS Setup	34
Entering the BIOS Setup	34
Main Page	36
Advanced Settings	36
Boot Configuration	37
SATA Configuration	37
Intel Rapid Storage Technology	39
CPU Configuration	40
Video Configuration	41
Chipset Configuration	42
PCH-FW Configuration	43
Console Redirection	44
SIO ITE8786E	45
Security Settings	47
Current TPM Device	47
TPM State	47
Clear TPM	47
Set Supervisor Password	48
Power Settings	50
Wake on LAN	50
Auto Wake on S5	50
Boot Settings	51
Network Stack	51

PXE Boot capability	51
USB Boot	51
Timeout	52
EFI	52
Exit Settings	53
Exit Saving Changes	53
Save Change Without Exit	53
Exit Discarding Changes	53
Load Optimal Defaults	53
Load Custom Defaults	54
Save Custom Defaults	54
Discard Changes	54
Enabling AMT	54
Using AMT	57
Administering Secure Boot	58
Enabling UEFI Secure Boot	59
Enroll EFI Image	59
Enroll Customer Key	60
Upgrading the BIOS	62
A. Regulatory Approval Statement	66

1. Introduction

This chapter gives a general overview of the V3200 computer's hardware features and specifications.

Overview

The V3200 Series embedded computers are built around an Intel® Core™ i7/i5/i3 or Intel® Celeron® high-performance processor and come with up to 64 GB RAM, one M.2 2280 M key slot, and two HDD/SSD for storage expansion. The computers are compliant with EN 50155 and EN 50121-4 standards covering operating temperature, power input voltage, surge, ESD, and vibration, making them suitable for railway onboard and wayside applications.

For connecting with onboard and wayside systems and devices, the V3200 computers are equipped with a rich set of interfaces including 4 Gigabit Ethernet ports (default; can go up to 8 ports) with one-pair LAN bypass function to ensure uninterrupted data transmission, 2 RS-232/422/485 serial ports, 2 DIs, 2 DOs, and 2 USB 3.0 ports. The built-in TPM 2.0 module ensures platform integrity and provides hardware-based security as well as protection from tampering.

Vehicular applications require reliable connectivity. They also require clear indicators on the device that identify the status of the software. The V3200 computers come with one LTE and 6 SIM-card slots to help establish redundant LTE/Wi-Fi connections and three programmable LEDs that enable monitoring of the runtime status of software.

Package Checklist

The following items are included in the package.

- V3200 Series embedded computer
- Wall-mounting kit
- 2 HDD trays
- 16 screws for securing the HDD trays
- HDMI cable locker
- Quick installation guide (printed)
- Warranty card



NOTE

Notify your sales representative if any of the above items are missing or damaged.

Product Features

- Intel® Celeron®/Intel® Core™ i3/i5/i7 embedded computer for in-vehicle applications
- Variety of interfaces: 8 GbE ports, 2 serial ports, 2 DIs, 2 DOs, 2 USB ports, and 1 M.2 B/E key for wireless
- Supports dual independent displays (VGA and HDMI with 4K resolution)
- Native TSN support (for models with i7-1185GRE processor)
- Onboard TPM module for enhanced cybersecurity
- Complies with all EN 50155 mandatory test items
- Compliant with EN 50121-4
- IEC 61373 certified for shock and vibration resistance

*This product is suitable for rolling stock railway applications, as defined by the EN 50155 standard. For a more detailed statement, click here: www.moxa.com/doc/specs/EN_50155_Compliance.pdf

Hardware Specifications

For the product hardware specifications, refer to Moxa's website: <https://www.moxa.com>.

Hardware Block Diagram

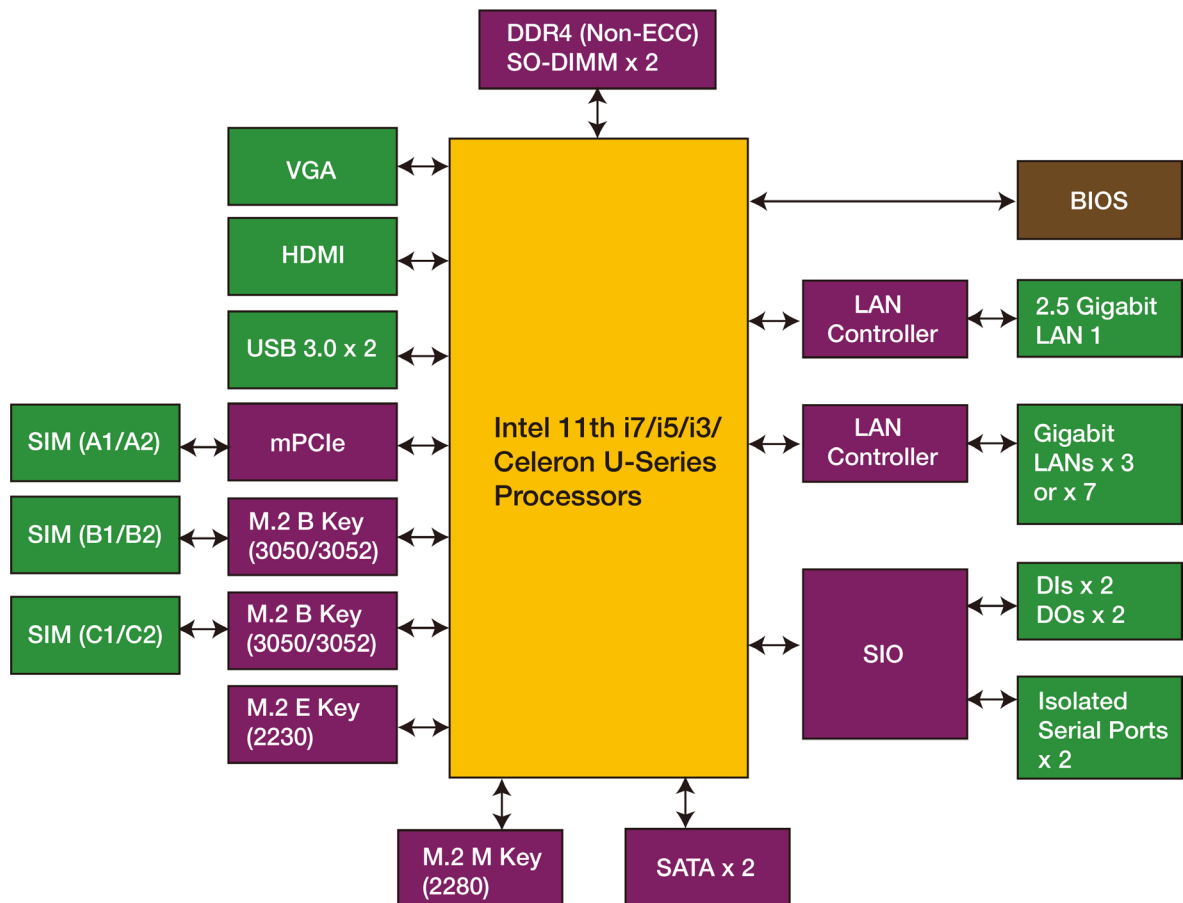

2. Hardware Introduction

V3200 embedded computers are compact and rugged for use in industrial applications. LED indicators help you monitor performance and identify trouble spots, multiple serial ports allow you to connect a variety of devices for wireless operation, and the reliable and stable hardware platform lets you devote your attention to developing your applications, rather than diddling with low-level APIs and device drivers.

Appearance

Front View

V3200-TL-8L Models

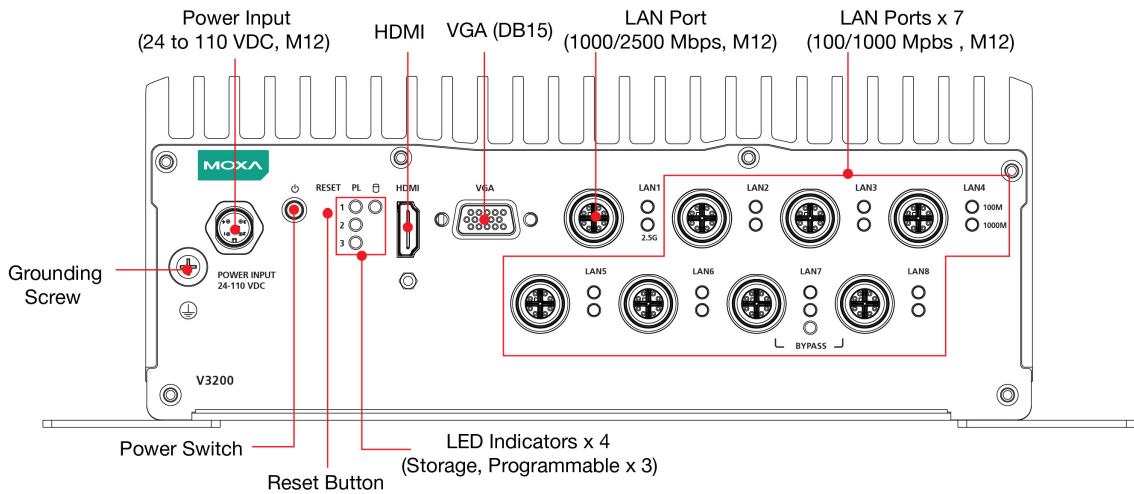

V3200-TL-4L Models

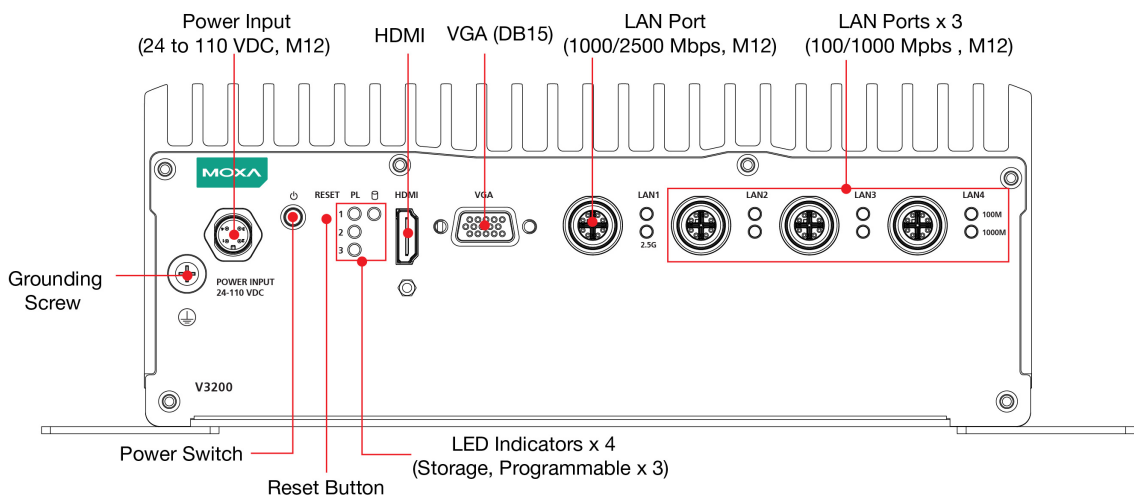

Rear View

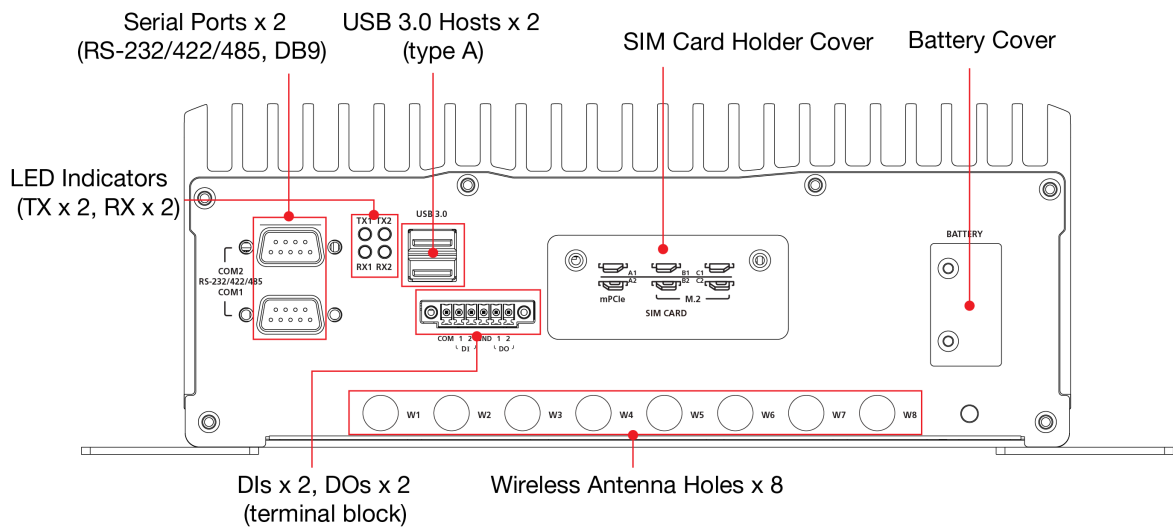

Dimensions

V3200-TL-8L Models

Unit: mm (inch)

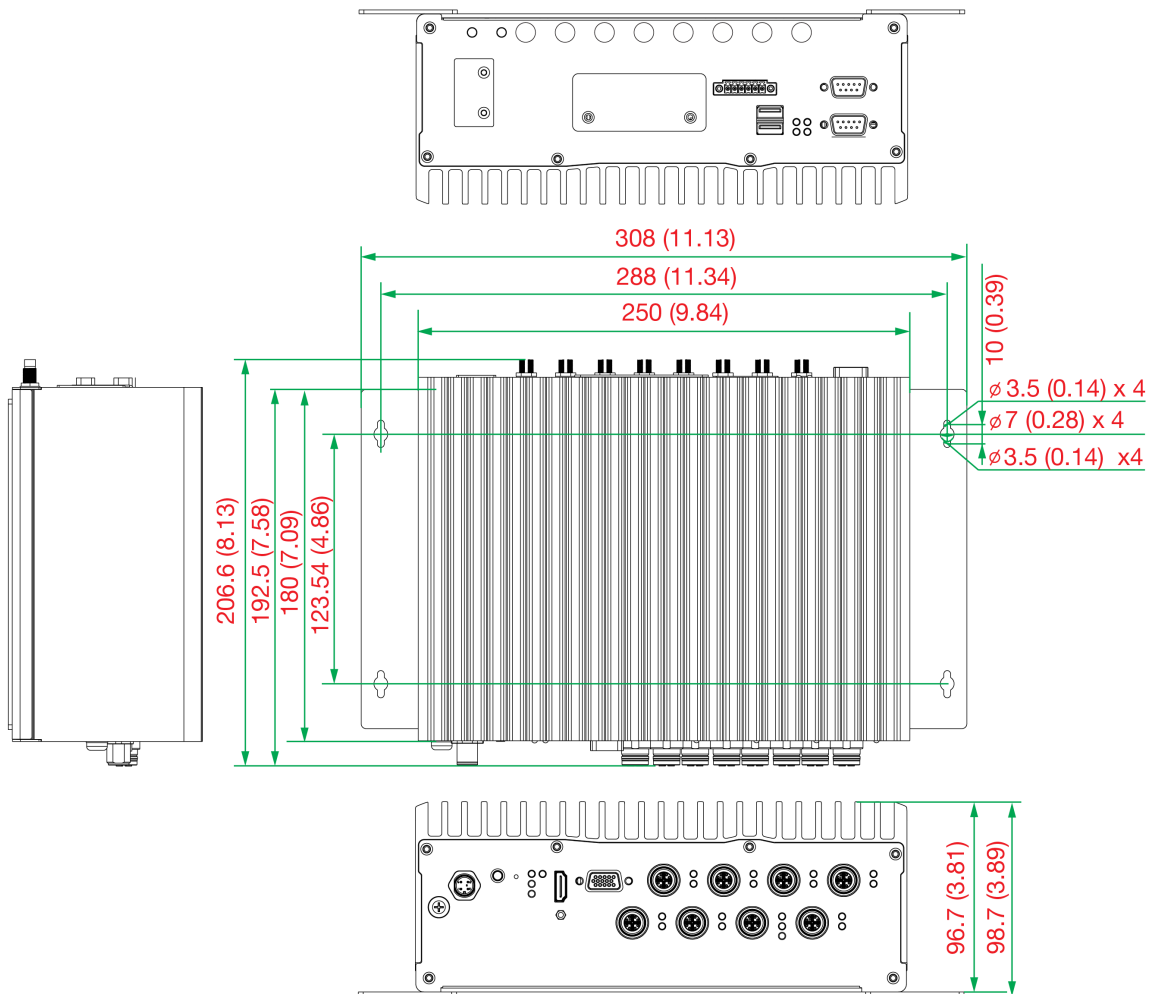

V3200-TL-4L Models

Unit: mm (inch)

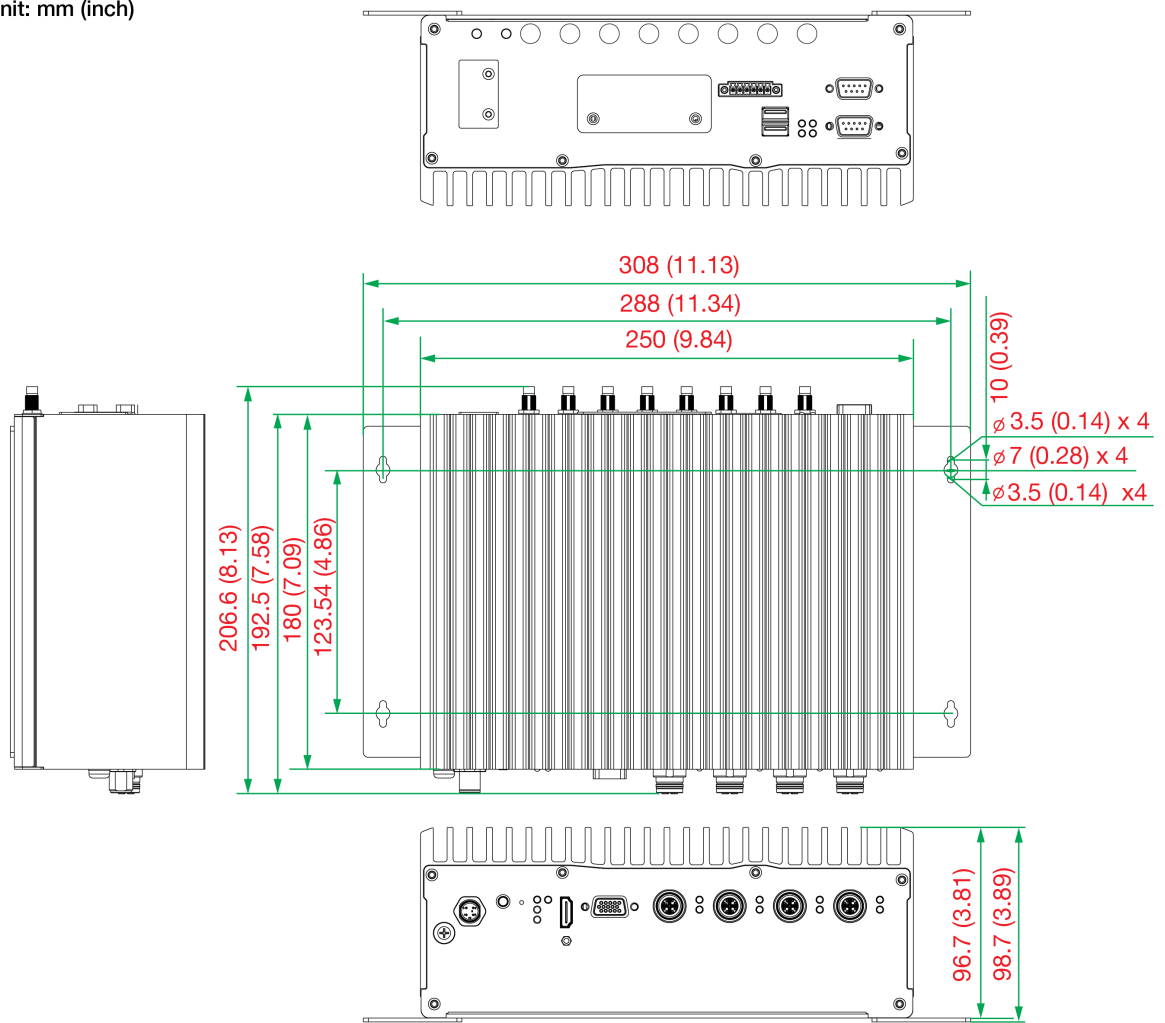

LED Indicators

The following table describes the LED indicators located on the front and rear panels of the V3200 Series computer.

LED Name	Status	Function
Power (Power button)	Green	Power is ON
	Off	No power input/other power-input error
Ethernet (100 Mbps) (1000 Mbps)	Green	Steady ON: 100 Mbps Ethernet link Blinking: Data transmission is in progress
	Yellow	Steady ON: 1000 Mbps Ethernet link Blinking: Data transmission is in progress
	Off	Data transmission speed at 10 Mbps or the cable is not connected
Ethernet (1000 Mbps) (2500 Mbps) LAN1	Green	Steady ON: 1000 Mbps Ethernet link Blinking: Data transmission is in progress
	Yellow	Steady ON: 2500 Mbps Ethernet link Blinking: Data transmission is in progress
	Off	Data transmission speed at 100/10 Mbps or the cable is not connected
Serial (TX/RX)	Green	Tx: Serial port is transmitting data
	Yellow	Rx: Serial port is receiving data
	Off	No operation
Storage	Yellow	Data is being accessed from either the M.2 M key (PCIe [x4]) or the SATA drive
	Off	Data is not being accessed from the storage drives
LAN Bypass LED (I/O board)	Yellow	LAN bypass mode is activated
	Off	No operation
Programmable LED (Main board*3)	Green	Application active normally, blinking or frequency adjustment
	Off	No operation

Real-time Clock

The embedded computer's real-time clock is powered by a lithium battery. We strongly recommend that you **DO NOT** replace the lithium battery on your own. If the battery needs to be changed, contact the Moxa RMA service team.



ATTENTION

There is a risk of explosion if the wrong type of battery is used. To avoid this potential danger, always be sure to use the correct type of battery. Contact the Moxa RMA service team if you need to replace your battery.

Caution

Dispose of used batteries in a suitable manner. Consult the battery manufacturer for details on disposing batteries.

3. Hardware Connection Description

In this chapter, we show how to connect the embedded computers to the network and to a variety of common devices.

Installing the V3200

Wall or Cabinet Mounting

The V3200 computer comes with 2 wall-mounting brackets. Attach the brackets to the computer using 4 screws on each side. Ensure that the mounting brackets are attached to the V3200 computer in the direction shown in the following figure.

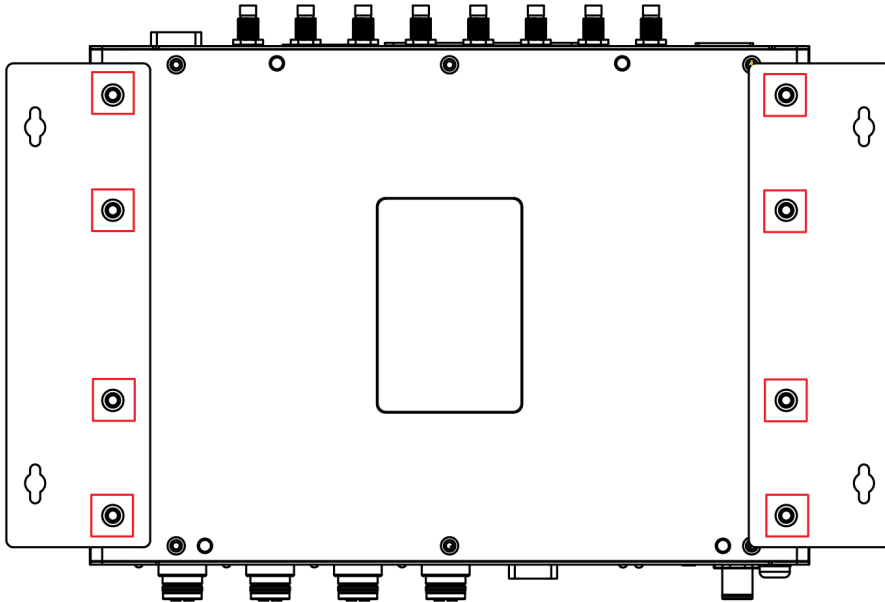

The 8 screws for the mounting brackets are included in the product package. They are standard IMS_M3x5L screws and require a torque of 4.5 kgf-cm. Refer to the following illustration for details.

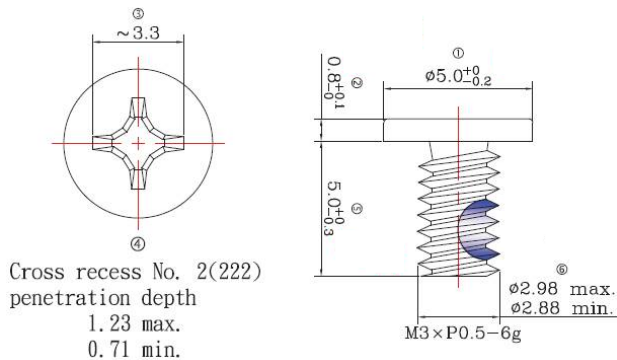

Use 2 screws (M3*5L standard is recommended) on each side to attach the V3200 to a wall or cabinet. These 4 screws are not included in the product package; they need to be purchased separately. Ensure that the V3200 computer is installed in the direction shown in the following figure:

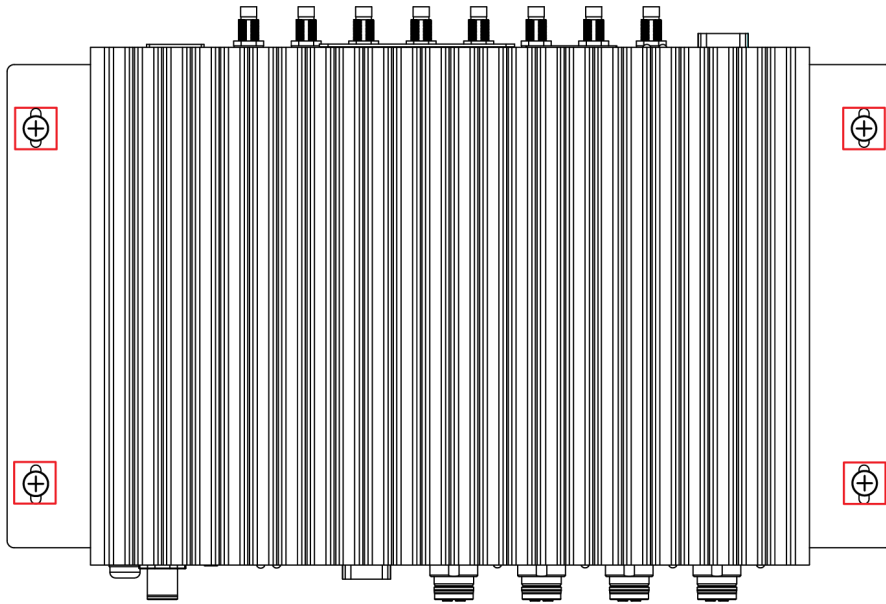

Wiring Requirements

This section describes how to connect peripheral devices to the embedded computer.

You should read and follow these common safety precautions before proceeding with the installation of any electronic device:

- Use separate paths to route wiring for power and devices. If power wiring and device wiring paths must cross, ensure that the wires are perpendicular at the intersection point.



ATTENTION

Do not run signal or communication wiring together with power wiring in the same wire conduit. To avoid interference, wires with different signal characteristics should be routed separately.

- Use the type of signal transmitted through a wire to determine which wires should be kept separate. The rule of thumb is that wiring that shares similar electrical characteristics can be bundled together.
- Keep input wiring and output wiring separate.
- It is advisable to label the wiring to all devices in the system.



ATTENTION

Safety First!

Be sure to disconnect the power cord before installing and/or wiring your V3200.

Wiring Caution!

Calculate the maximum possible current in each power wire and common wire. Observe all electrical codes dictating the maximum current allowable for each wire size.

If the current goes above the maximum ratings, the wiring could overheat, causing serious damage to your equipment.

Temperature Caution!

Be careful when handling the unit. When the unit is plugged in, the internal components generate heat, and consequently the outer casing may feel hot to the touch.

Connecting the Power

The V3200 computers are provided with M12 power input connectors on the front panel. Connect the power cord wires to the connectors and then tighten the connectors. Push the power button; the Power LED (on the power button) will light up to indicate that power is being supplied to the computer. It should take about 30 to 60 seconds for the operating system to complete the boot-up process.

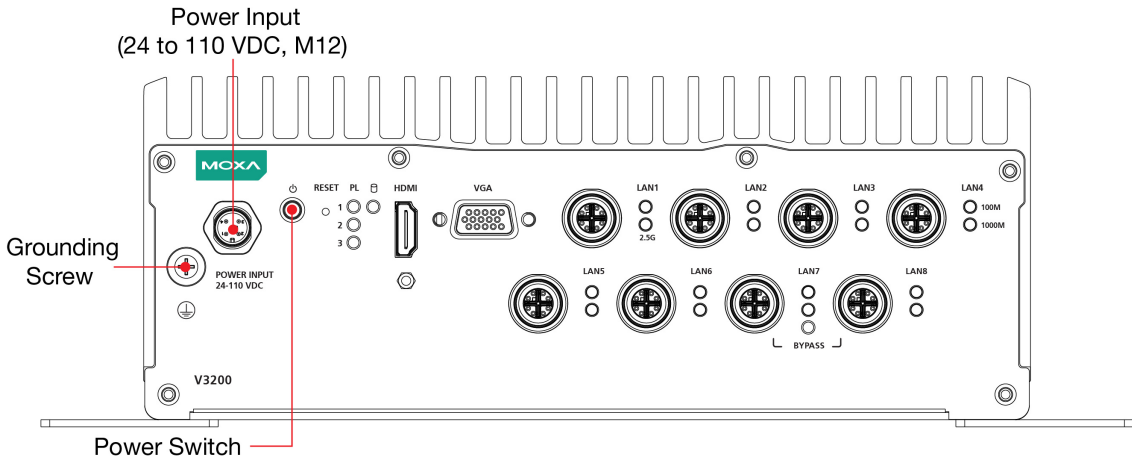

Pin	Definition
1	V+
2	N.C.
3	V-
4	N.C.

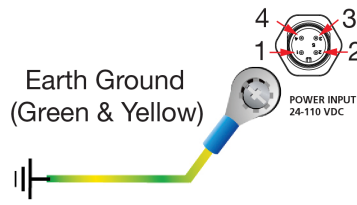

Min. 18 AWG

The power input specification is given below:

- DC mains with a power source rating of 24 V @ 2.74 A; 100 V @ 0.584 A, and a minimum of 18 AWG.



ATTENTION

For safety reasons, refer to the following instructions on power input installation.

1. The power switch or circuit breaker between Moxa's products and the power supply should easily disconnect if a power overcurrent occurs.
2. The maximum branch circuit over current protection rate should be 20 A.
3. The DC power source wire specifications should be a minimum 14 AWG and comply with VW-1 or FT-1 standards.

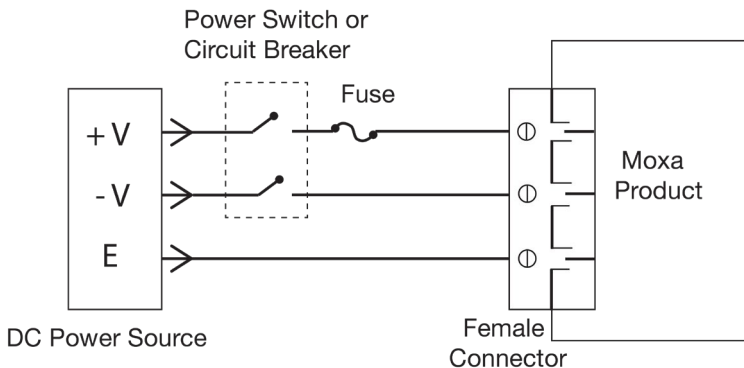

For surge protection, connect the grounding connector located below the power connector with the earth (ground) or a metal surface.

Grounding the Unit



For surge protection, connect the grounding connector located beside the power connector with the earth (ground) or a metal surface.

Connecting Data Transmission Cables

This section describes how to connect V3200 embedded computers to a network and serial devices.

Connecting to the Network

There are one 1000/2500 Mbps and three 100/1000 Mbps Ethernet ports for V3200-TL-4L models, one 1000/2500 Mbps and seven 100/1000 Mbps Ethernet ports for V3200-TL-8L models. Both use M12 X-coded connectors and are located on the front panel of the computer.



ATTENTION

There is risk of damage to the M12 X-coded cable due to improper installation or removal.

Before you attach an M12 X-coded cable to an Ethernet port on the V3200, read the instructions carefully.

The M12 X-coded cable is designed with locking mechanisms to prevent pin misalignment. Ensure that you properly align the indicator and notches when connecting the cable.

Do NOT insert the cable into a port with excessive force.

Refer to the following figure for the specific location of the Ethernet ports.

V3200-TL-4L Models

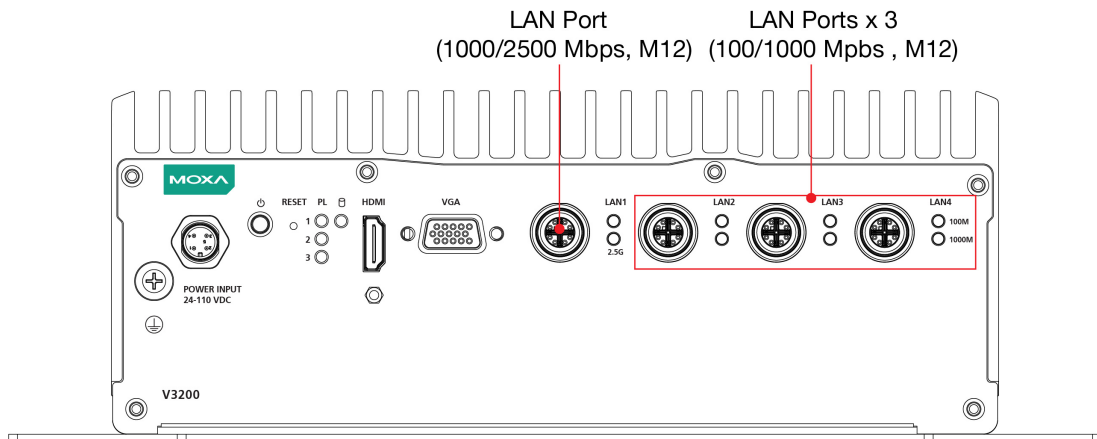

V3200-TL-8L Models

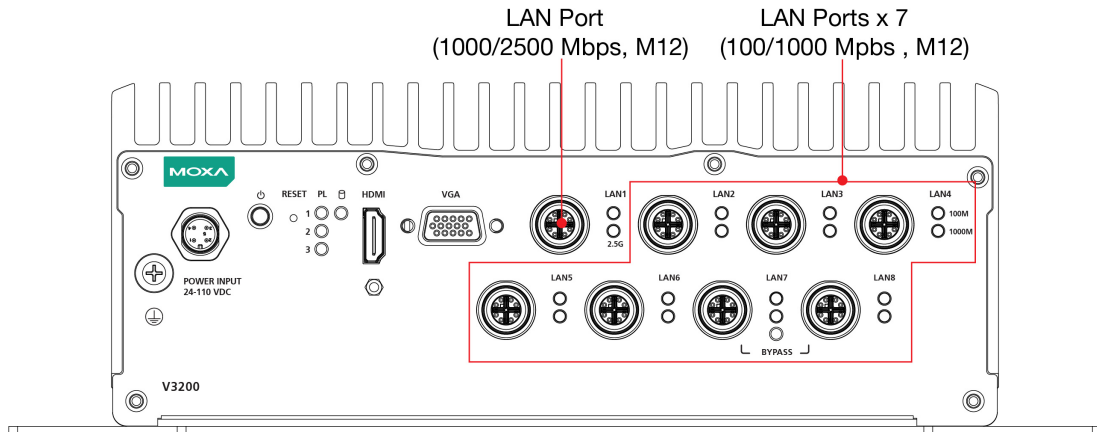

Refer to the following figure for the pin assignments of the Ethernet ports.

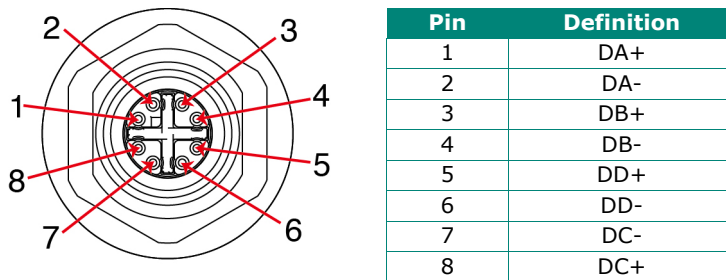

Follow the steps below to connect an M12 X-coded cable to the computer:

1. Obtain an M12 X-coded cable.

The following table shows the Ethernet connector and cable options. For more information, contact your local Moxa sales representative.

Model Name	Type	Description
CBL-M12XMM8PRJ45-BK-100-IP67	Cable and connector	1-meter X-coded M12-to-RJ45 Cat-5E UTP Gigabit Ethernet cable, 8-pin male M12 connector, IP67-rated.
M12X-8PMM-IP67	Connector	Field-installation X-coded screw-in Gigabit Ethernet connector, 8-pin male, M12 connector, IP67-rated.



NOTE

For best performance and transmission quality, Moxa strongly recommends that you use cables and connectors from Phoenix Contact.

2. Align the notch on the M12 X-coded cable pin core with the notch on the port socket.

Pin assignment of M12 plug. 8-pos., X-coded, pin side view M12 socket pin assignment 8-pos., socket side view

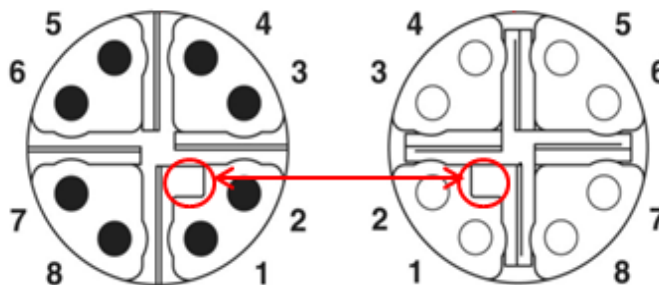

- Connect the M12 X-coded cable to the port.



NOTE

Do NOT use excessive force to push the M12 X-coded cable into the port.

- Turn the interlock screw to tighten it over the cable without using a mechanical tool (such as a screw wrench).



Connecting to a Serial Device

The V3200 comes with two serial ports, which can be configured for RS-232/422/485 interfaces. These ports are located on the rear panel.

Serial Ports x 2
(RS-232/422/485, DB9)

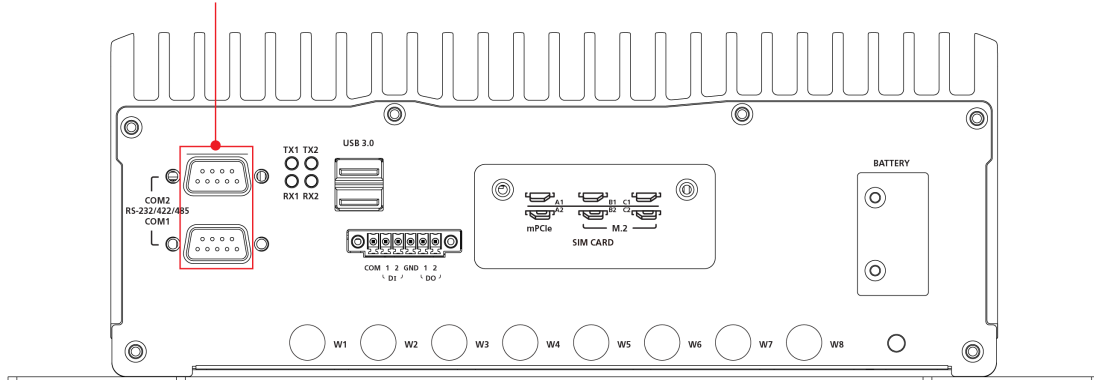

Use a serial cable to connect your serial device to the embedded computer's serial port. These ports have male DB9 connectors and can be configured for RS-232, RS-422, or RS-485 using the software. The pin assignments of the ports are shown in the table below:

DB9 Male Port

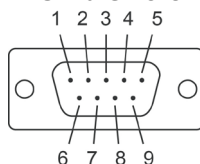

RS-232/422/485 Pinouts

Pin	RS-232	RS-422	RS-485-4W	RS-485-2W
1	DCD	TxDA(-)	TxDA(-)	-
2	RxD	TxDB(+)	TxDB(+)	-
3	TxD	RxDB(+)	RxDB(+)	DataB(+)
4	DTR	RxDA(-)	RxDA(-)	DataA(-)
5	GND	GND	GND	GND
6	DSR	-	-	-
7	RTS	-	-	-
8	CTS	-	-	-



NOTE

This is the pin assignment for the computer-side connectors on the V3200. If you are wiring peripheral-side connectors for a serial cable, you will need to match the pin assignment of the connectors.

Digital Inputs/Outputs

The V3200 comes with 2 digital inputs and 2 digital outputs in a terminal block.

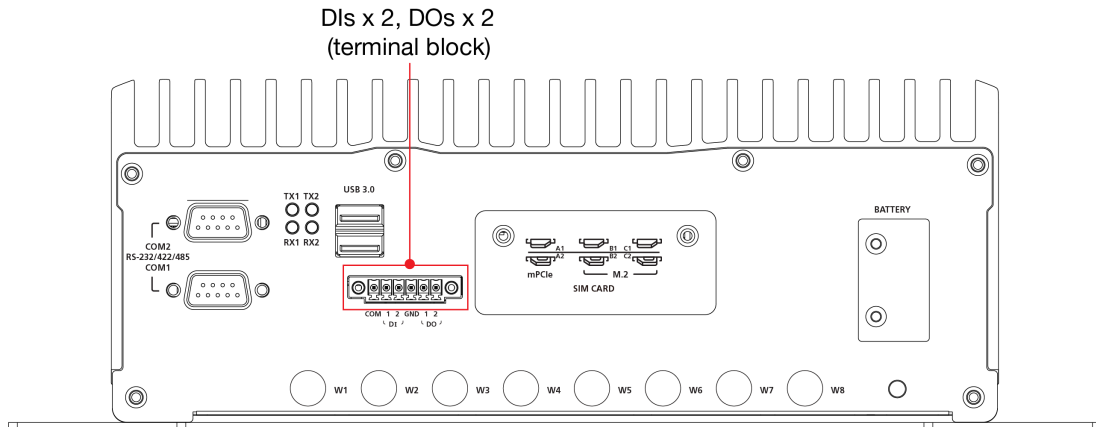

Refer to the following figures for the pin definitions and the current ratings.

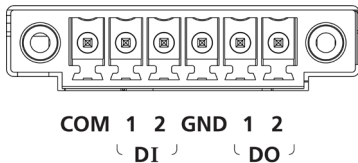

Digital Inputs

Dry Contact

Logic 0: Close to Ground

Logic 1: Open

Wet Contact (COM to DI)

Logic 0: 10 to 30 VDC

Logic 1: 0 to 3 VDC

Digital Outputs

Current Rating: 200 mA per channel

Voltage: 24 to 30 VDC

The wiring methods are shown in the diagram below:

DI Dry Contact

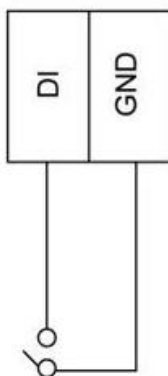

DI Wet Contact

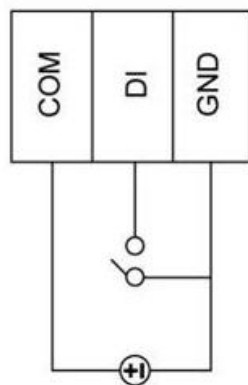

DO Contact

Sink

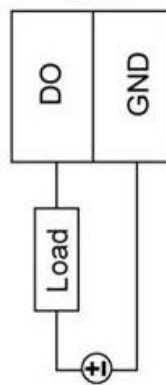

NOTE

If you are using wet contacts, you must connect the source to the power. In addition, both DI and DO can only be wired as sink types.

Connecting the Displays

The V3200 comes with a D-Sub 15-pin female connector on the front panel to connect a VGA monitor. To ensure that the monitor image remains clear, tighten the monitor cable after connecting it to the V3200. The pin assignments of the video output connector are shown in the diagram below:

DB15 Female Connector

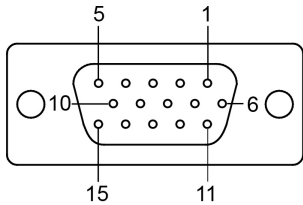

Pin No.	Signal Definition	Pin No.	Signal Definition
1	Red	9	VCC
2	Green	10	GND
3	Blue	11	NC
4	NC	12	DDC2B Data
5	GND	13	HSYNC
6	GND	14	VSYNC
7	GND	15	DDC2B Clock
8	GND		

In addition, an HDMI connector is also provided on the rear panel, allowing users to connect another display with an HDMI interface.

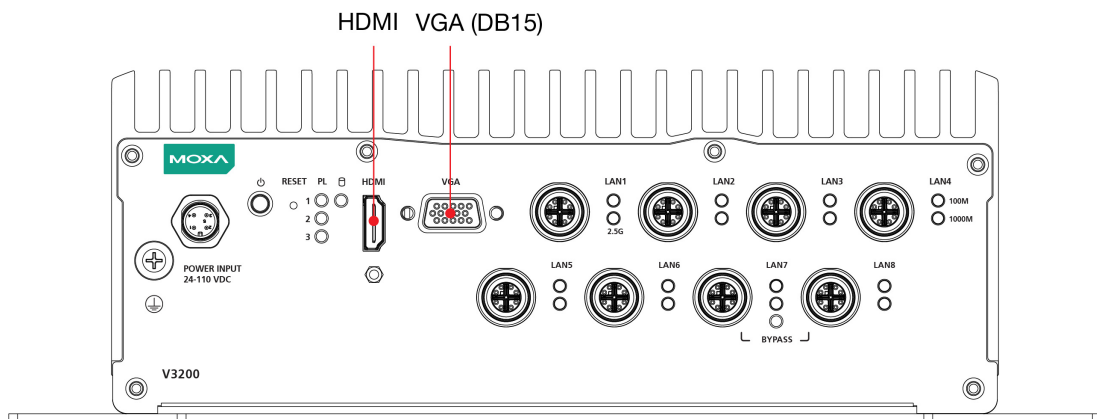

NOTE

For reliable video streaming capability, choose certified HDMI cables.

Connecting to the USB Ports

The V3200 comes with two USB ports on the rear panel. These ports come with USB 3.0 type A interfaces. Refer to the following illustrations for the location of these ports.

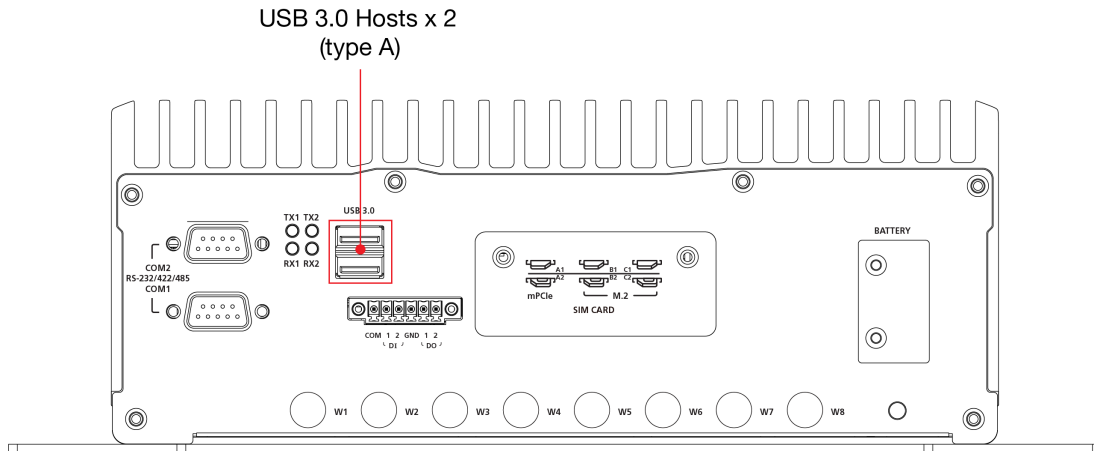

You can use these USB ports to connect various peripheral devices, such as a keyboard, a mouse, and USB storage disks, to your computer.

Installing the Storage Drive

The V3200 comes with two sockets that allow users to install two SSD for storage expansion. Follow the steps below.

1. Fasten the 12 screws on the back of the computer and take off the cover.

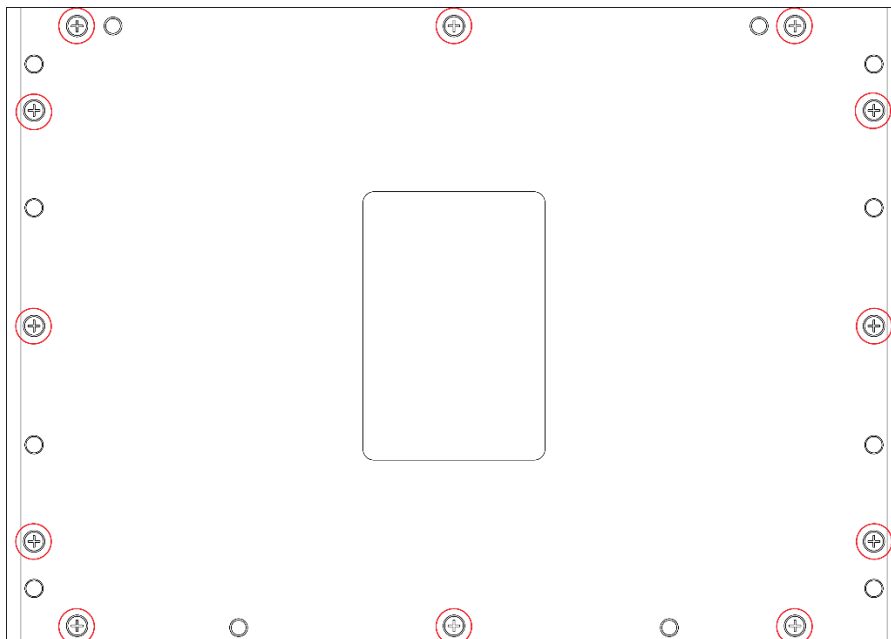

2. Find the location of the storage sockets.

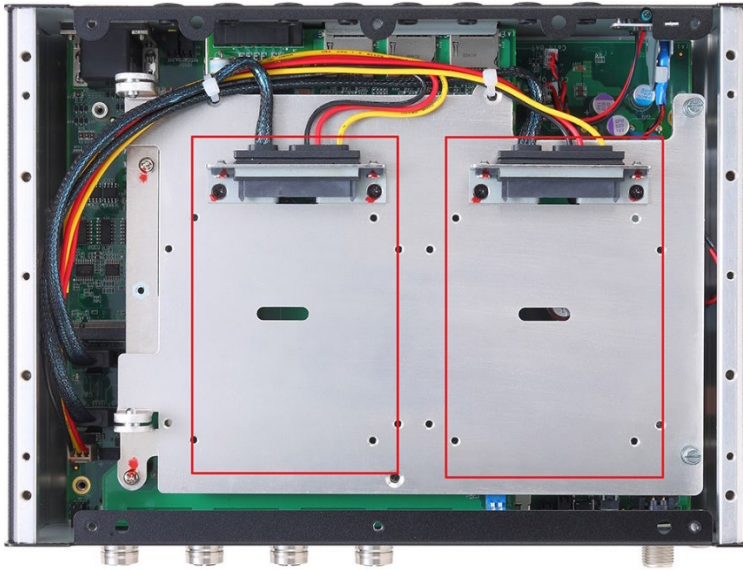

3. Take out the components from the SSD installation kit.

One SSD requires two brackets, four silver screws and four black screws.

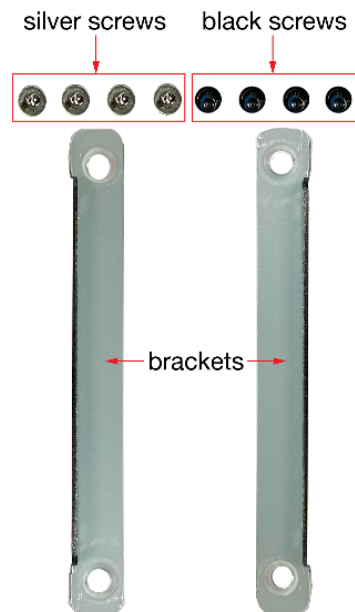

4. Attach the bracket with two black screws on each side of the SSD.



5. Install the SSD onto the socket and fasten four silver screws on two sides of the SSD.



6. Use the same steps to install the SSD on the other socket.
7. Reattach the screws on the rear cover of the computer.

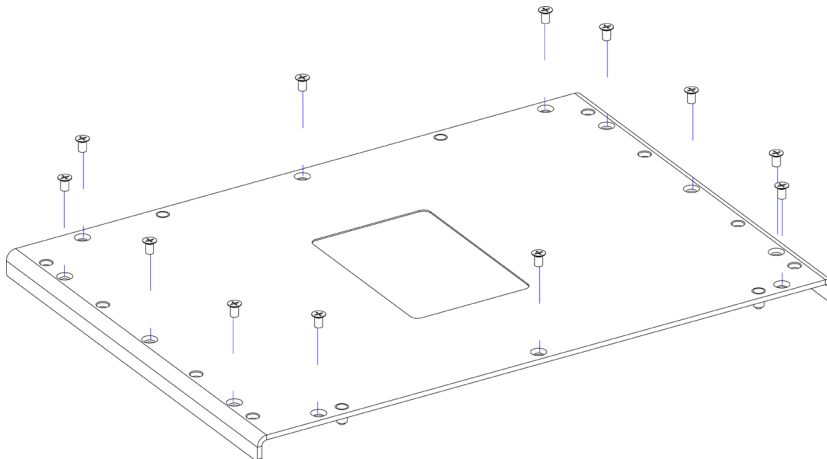

Installing the SIM Cards

The V3200 comes with 2 sockets, allowing users to install Wi-Fi or cellular modules. To install the cellular module, you need to install the SIM card first. Follow these steps.

1. Find the SIM card holder cover on the front panel.

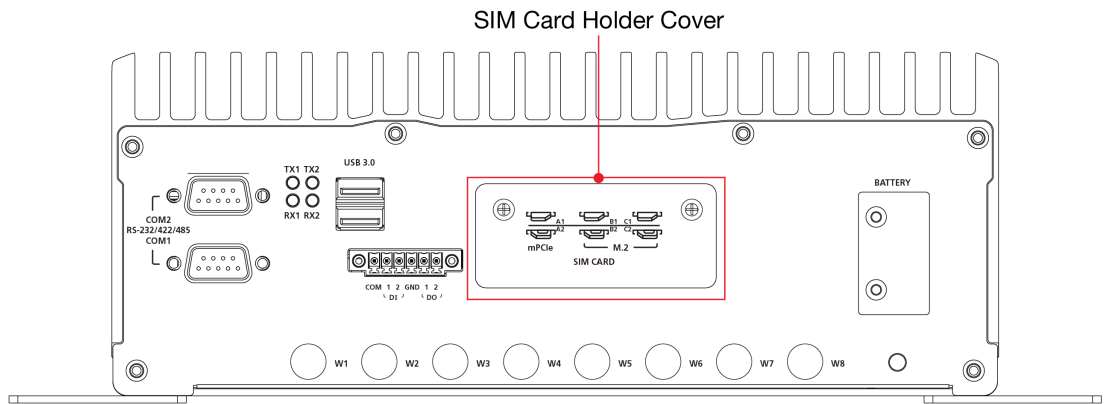

2. Unfasten the two screws on the cover and remove the cover.

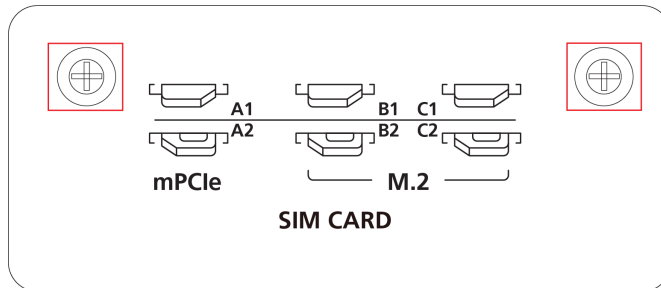

Each cellular module supports dual SIM cards and Micro SIM card type is also supported. Check the following diagram for the location of the SIM card slots.

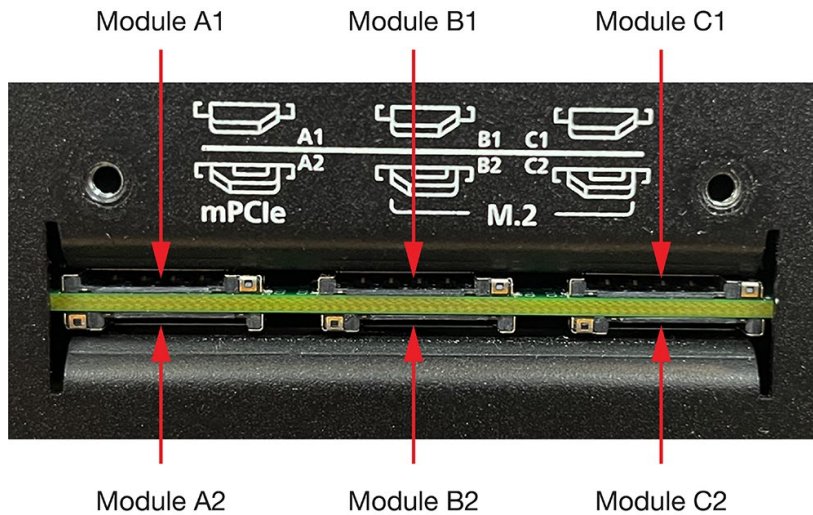

3. Check the illustration icon above the slots and insert the SIM card(s) in the correct direction.

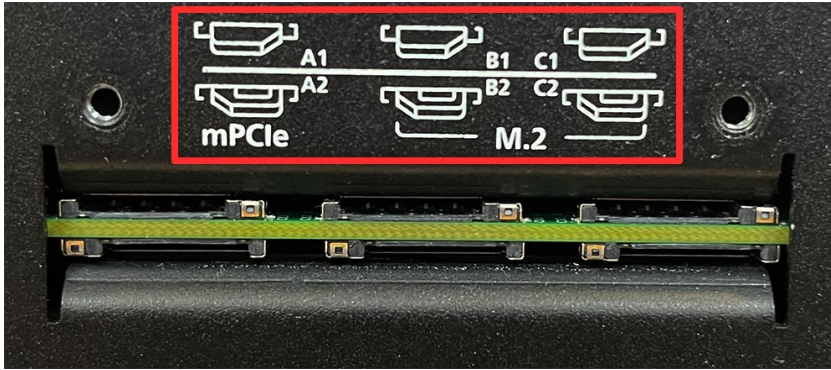

Inserting the SIM cards incorrectly may damage the slot and the SIM card. Check the following diagram to see the example of inserting the SIM card into the B2 slot.

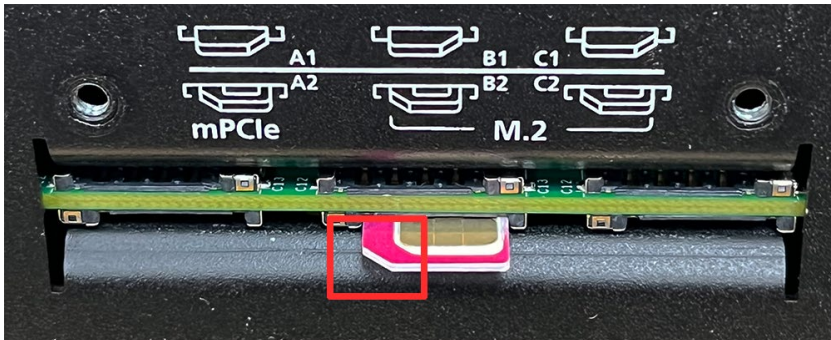

To remove the SIM card, simply push in the SIM card to release it and pull out the SIM card.

4. Replace the cover on the SIM card slot.

Installing the Wireless Modules

Follow these steps to install the wireless modules.

1. Remove the twelve screws on the bottom panel of the computer.

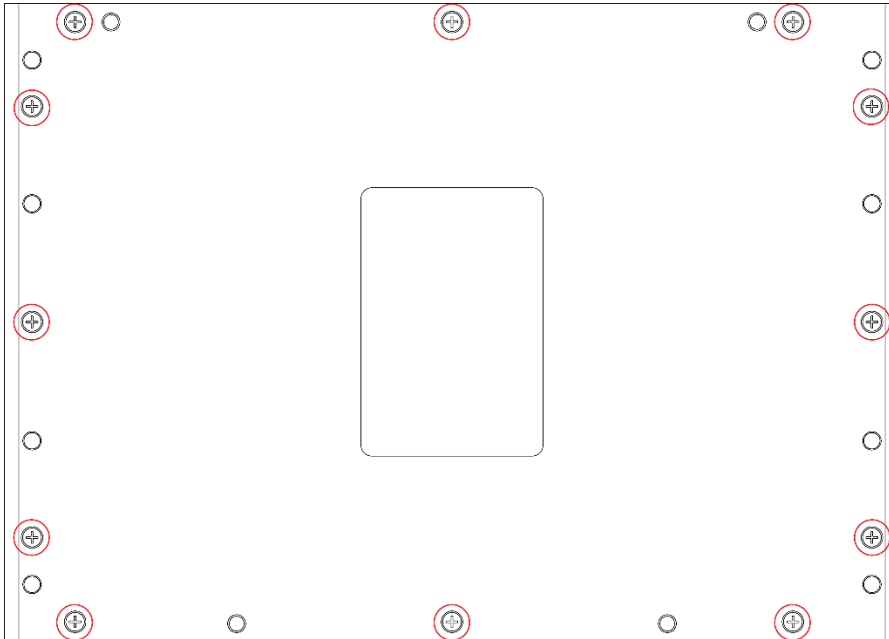

2. Remove the cover, unfasten two screws on the hard disk plate, and slide the plate to the left.

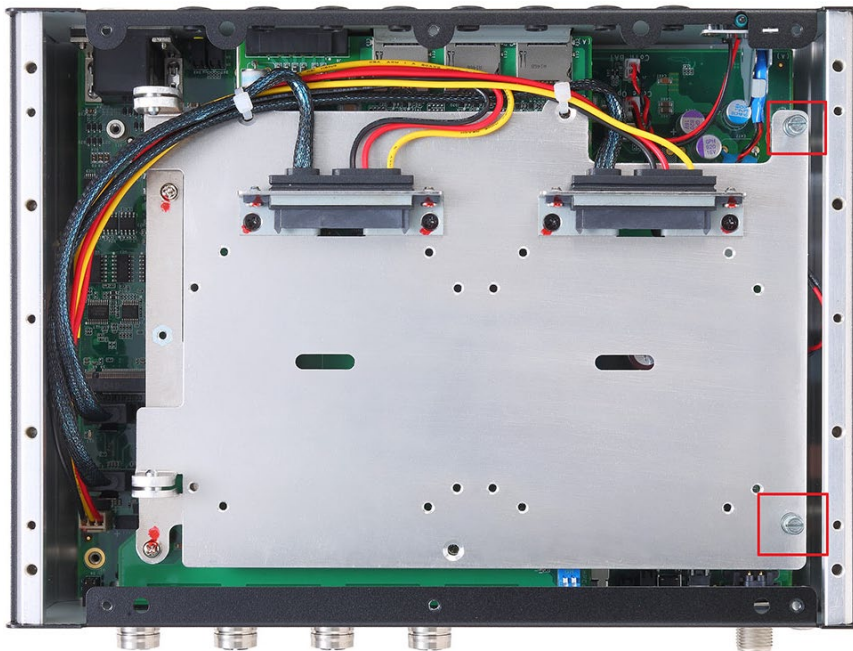

- Place the heat sink (included in the accessory package of the product box) and fasten the screws in the order specified here.

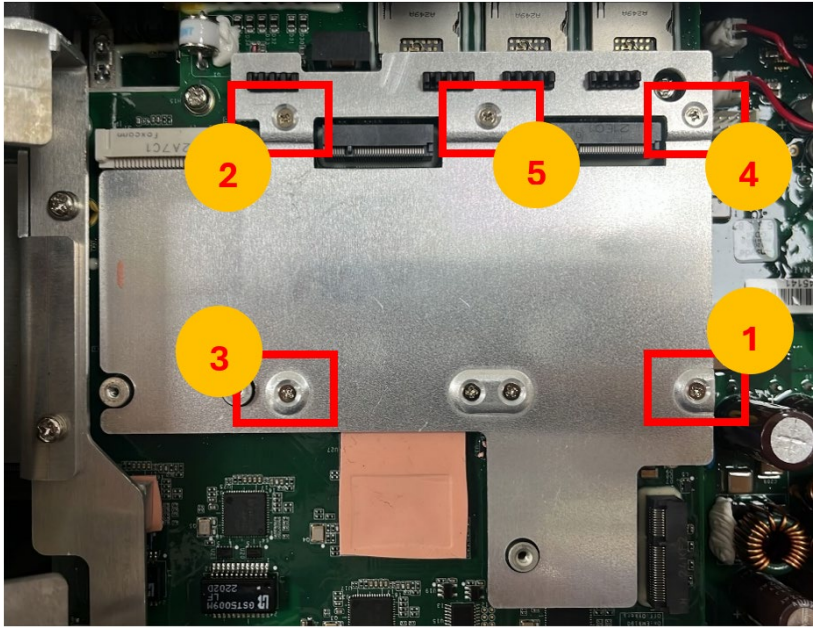

- Paste thermal pads on the heat sink as shown in the following figure.

4G/ Wi-Fi 5 Module
(mPCIe)

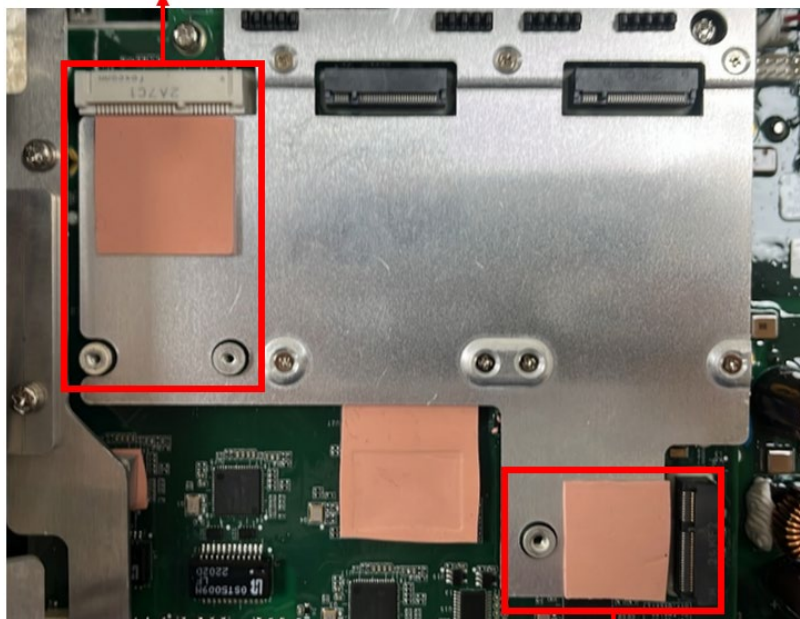

Wi-Fi 6 Module
(M.2 E Key)

Installing the 4G/Wi-Fi 5 Module

To install the 4G or Wi-Fi 5 module, do the following:

1. Insert the module into the socket.

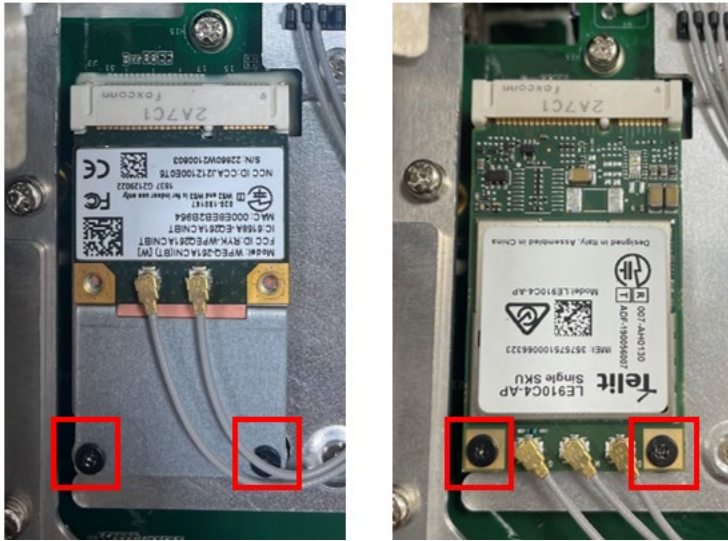

2. Fasten two black screws to secure the module.
3. Paste thermal pads on the module.

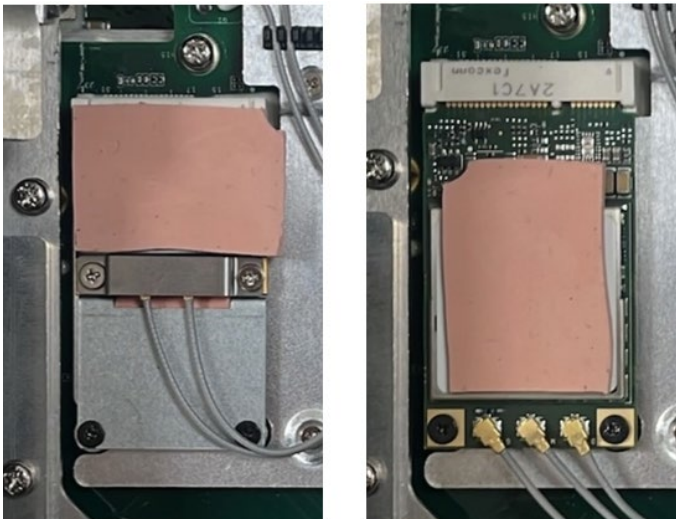

Installing the Wi-Fi 6 Module

To install the Wi-Fi 6 module, do the following:

1. Insert the module into the socket.



2. Fasten the silver screw to secure the module.
3. Paste thermal pads on the module.

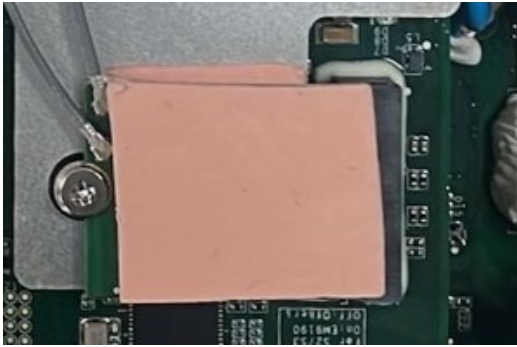

Installing Wireless Cables and Antennas

To connect wireless cables and antennas, do the following:

1. Confirm the wireless module has been installed and check the number of coaxial cables corresponding to the connectors on the module. Refer to the following figures for guidance.

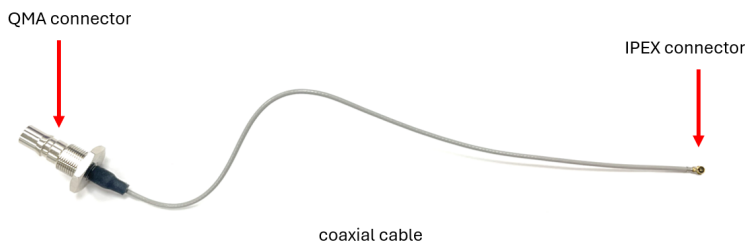
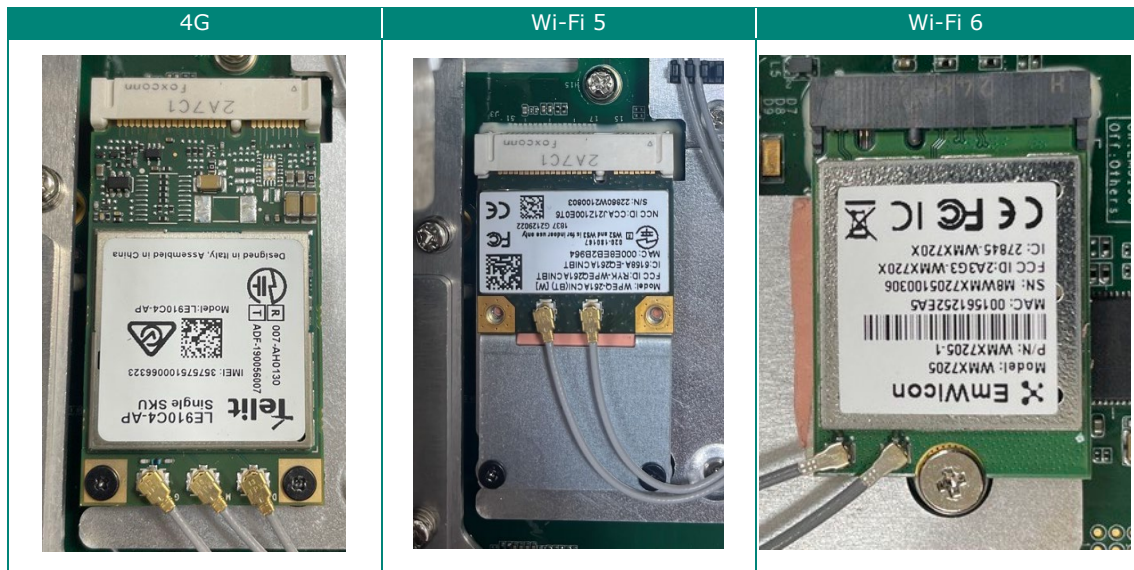

NOTE

The figures here are for illustration purposes only and may not corresponding to the product model purchased.

2. Connect the QMA connector end of the coaxial cable to the connector hole on the rear panel of the computer.

Refer to the following figure for the recommended locations for the connectors for the different types of modules.

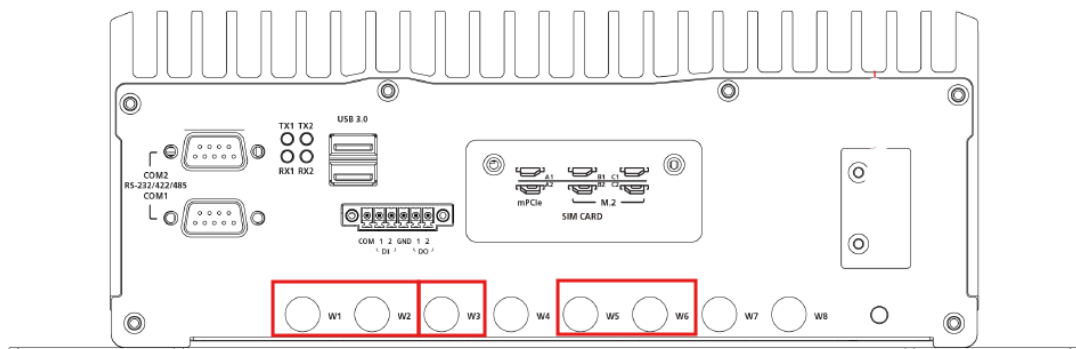

- W1, W2, and W3 are for 4G module.
- W1 and W2 are for Wi-Fi 5 module.
- W5 and W6 are for Wi-Fi 6 module.

3. Hold the lock washer against the rear panel and secure the antenna connector by tightening the nut onto the thread protection ring.
Each cable comes with its own lock washer and nut.

Lock Washer →   ← Nut

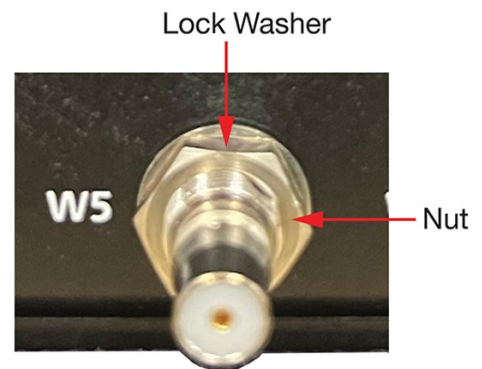

4. Plug one end of the IPEX connector of coaxial cables on the module.
Make sure to follow the order indicated on the panel for the QMA connectors.

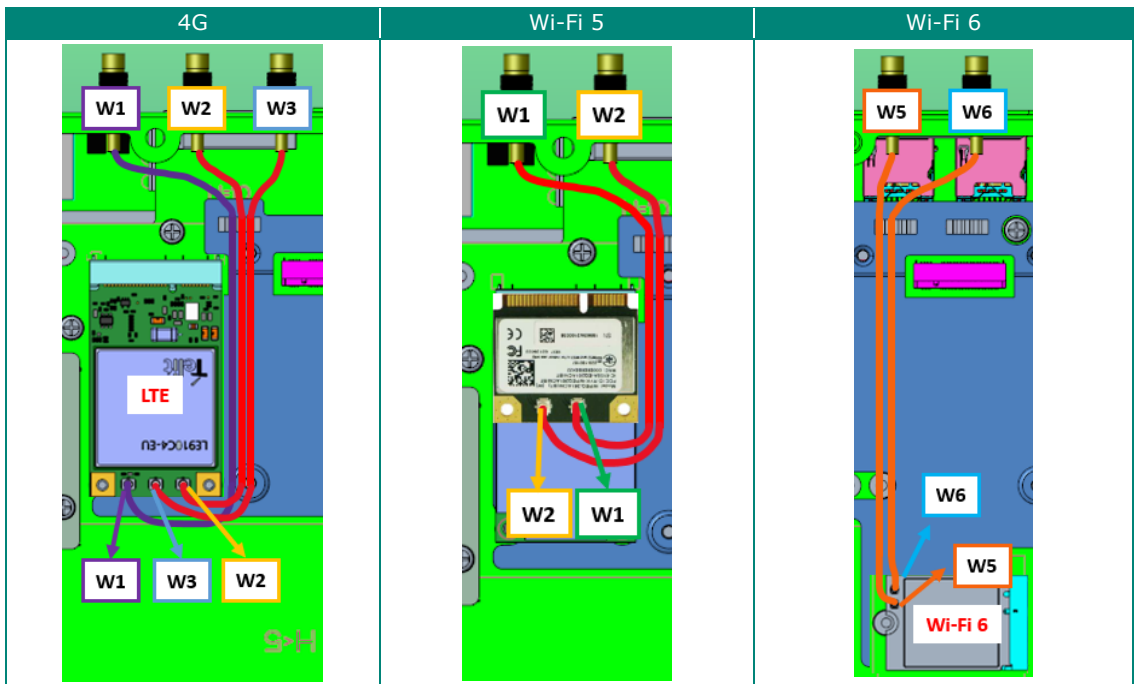

5. You can use black cable sockets above the modules to arrange the cables and stabilize them as shown in the following figure:



Switching the Wireless Module Socket

The computer comes with wireless module sockets for installing a Wi-Fi or 4G module. DIP switches are provided to enable installation of the module types required. The DIP switches are located below the sockets as shown in the following figure:

4G/ Wi-Fi 5 Module
(mPCIE)

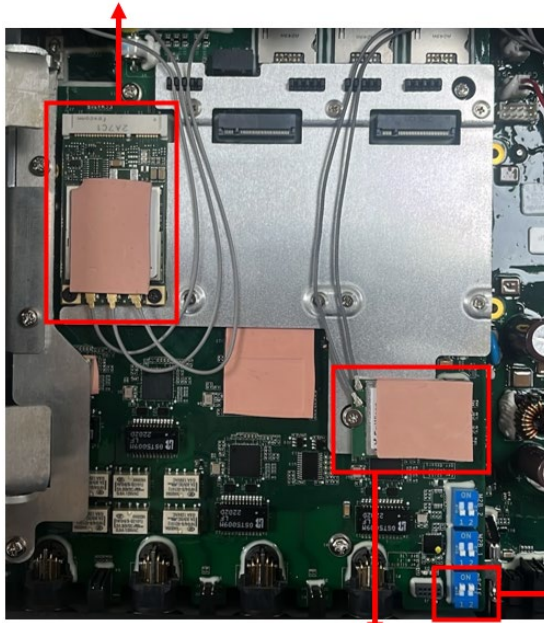

Wi-Fi 6 Module
(M.2 E Key)

Module socket
DIP switch
(for mPCIE)

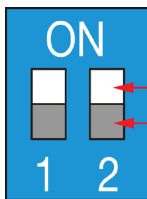

ON
OFF

S1	
ON	Wi-Fi module (socket 1)
OFF	4G module (socket 1)

For example, if you want to install a 4G module in socket 1, you need to turn S1 to OFF and ensure that the mPCIE#1 Power option is ON as well.

Replacing the Battery

The V3200 comes with one battery slot containing a lithium battery with the specifications 3 V / 195 mAh.

To replace the battery, do the following:

1. Locate the battery cover on the rear panel of the computer.

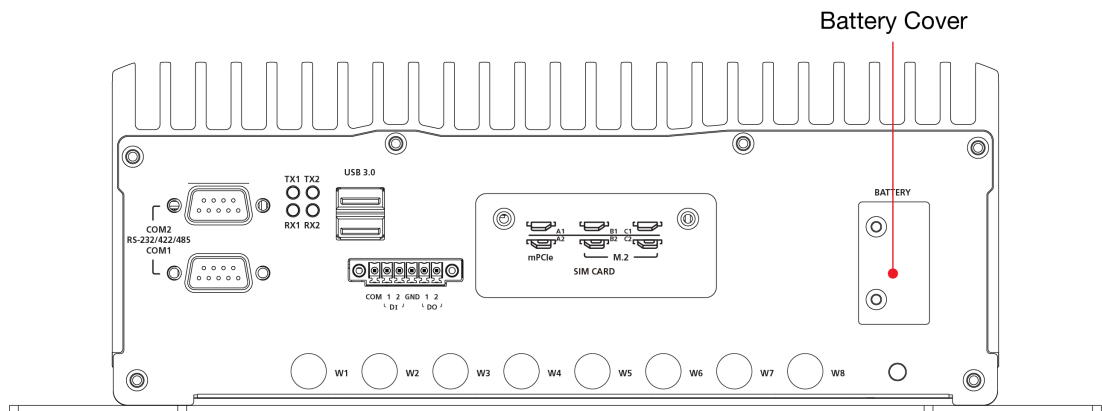

2. Unfasten the two screws on the battery cover.

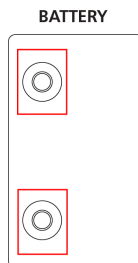

3. Remove the cover.

The battery is attached to the cover.

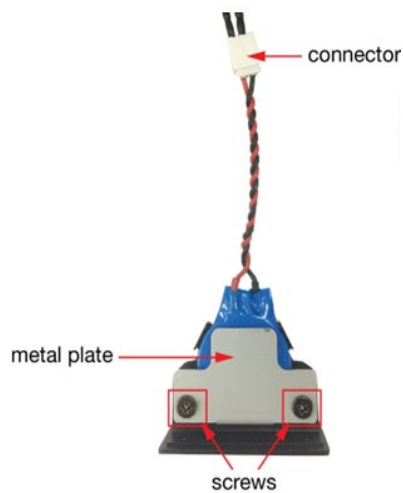

4. Separate the connectors and remove the two screws from the metal plate.



5. Replace the battery, place the metal plate on the battery, and fasten the screws to secure the batteries.
6. Reconnect the connectors, place the battery into the slot, and put back the cover.



7. Secure the cover with two screws.



NOTE

Ensure that you use the correct type of battery. Incorrect battery may cause system damage. Contact Moxa's technical support staff for assistance, if necessary.



NOTE

This computer is intended to be installed in a restricted access area. In addition, for safety reasons, the computer should be installed and handled only by qualified and experienced professionals.



NOTE

This computer is designed to be supplied by listed equipment and rated 24 to 110 VDC, minimum 2.74 to 0.584 A. If you need assistance with purchasing a power adapter, contact the Moxa technical support team.

4. BIOS Setup

In this chapter, we describe the BIOS settings for the V3200 computer. The BIOS is a set of input/output control routines for peripherals to initialize the basic settings. The BIOS helps boot the system before the operating system is loaded. The BIOS setup allows the user to modify the system configuration for basic input/output peripherals. All the configurations are stored in the CMOS RAM, which has a backup battery in case the computer is not connected to a power source. Consequently, the data stored in the CMOS RAM is retained when the system is rebooted, or the power is disconnected.

Entering the BIOS Setup

To enter the BIOS setup utility, press the F2 key while the system is booting up. The main BIOS Setup screen will appear. You can configure the following settings on this screen.

- Continue: Continue to boot up
- Boot Manager: Select the device for boot up
- Device Management: Enter the device configuration menu
- Boot From File: Select the UEFI boot up file
- Administer Secure Boot: Enter the Secure Boot menu
- Setup Utility: Enter the BIOS configuration menu
- Intel® Management Engine BIOS Extension: Enter the AMT configuration menu (not supported in models with Intel® Celeron® and Core™ i3 processors)

Select F2 to enter the BIOS configuration.

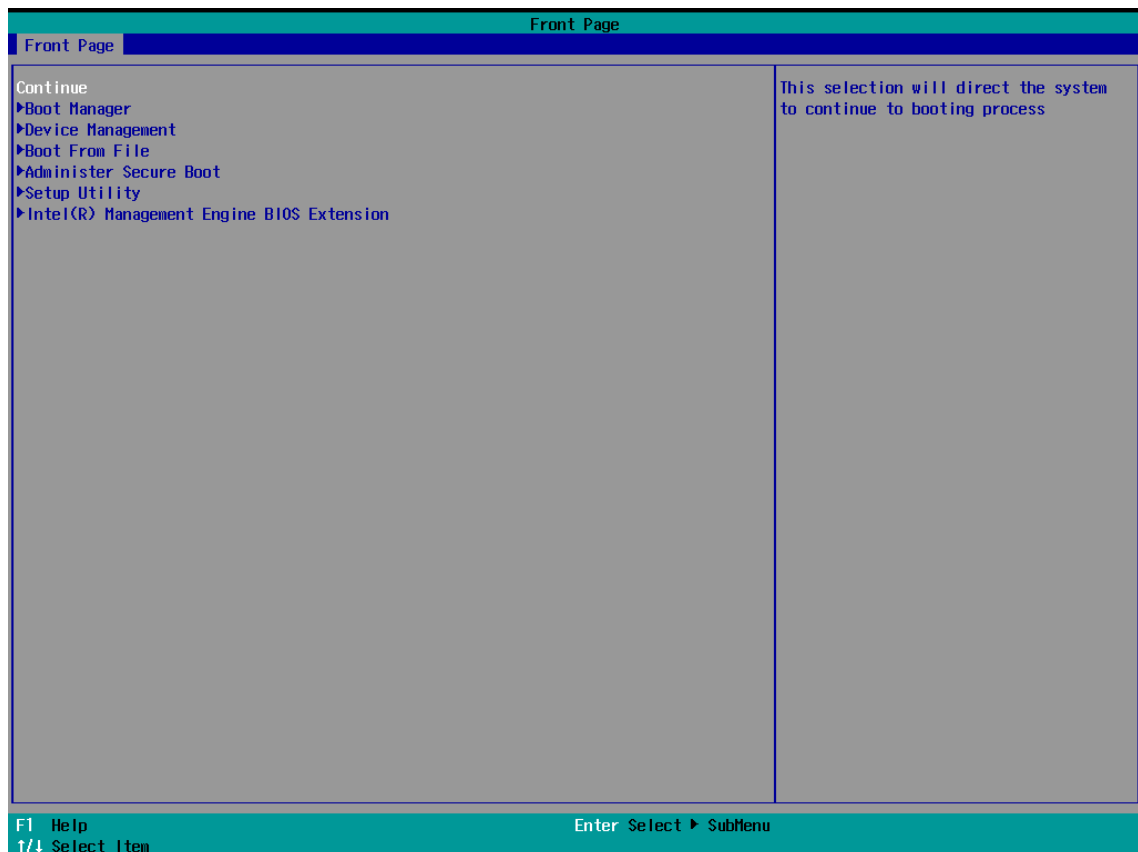

When you enter the Setup Utility, a basic description of each function key is listed at the bottom of the screen. Refer to these descriptions to learn how to use them.

F1	General Help	↑ ↓	Select Item
F5/F6	Change Values	← →	Select Menu
F9	Setup Defaults	ESC	Exit
F10	Save and Exit	ENTER	Select or go to Submenu.

The BIOS configuration screen is shown when you enter the Setup Utility option.

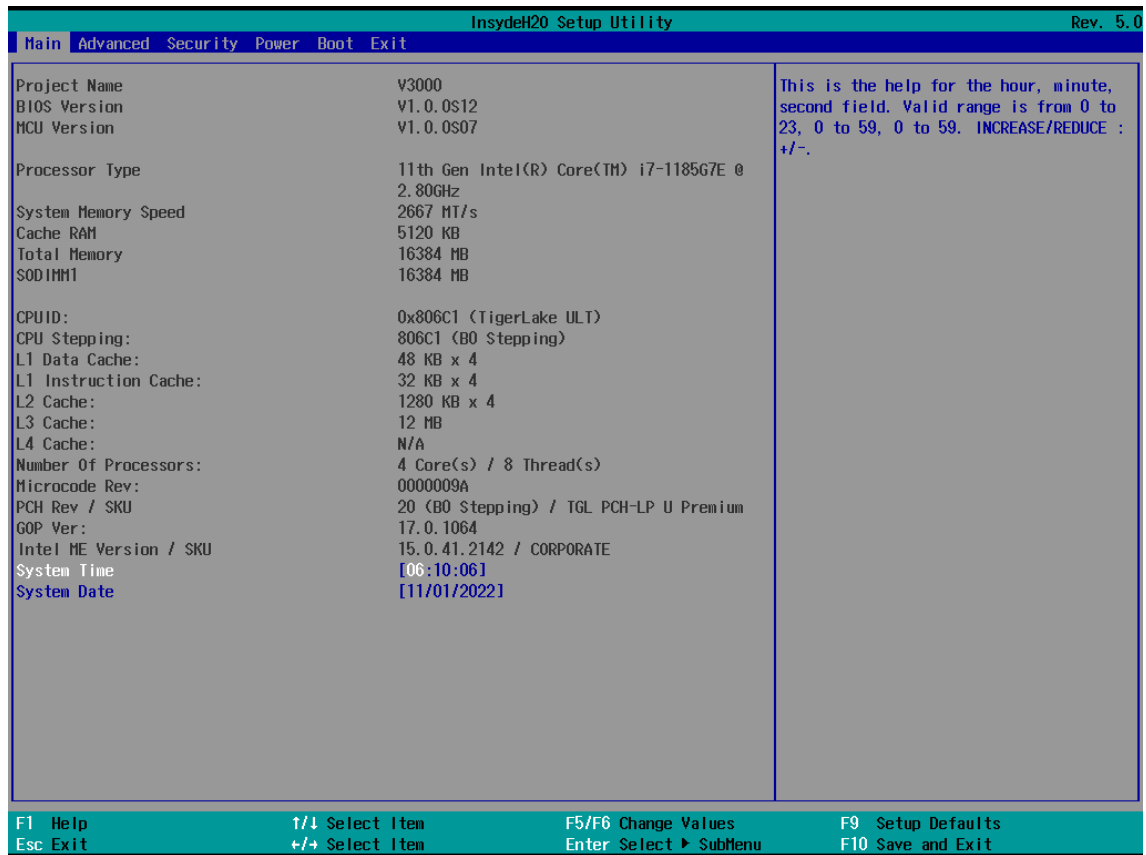

NOTE

The Processor Type information may vary depending on the model that you have purchased.

Main Page

The Main page displays basic hardware information, such as model name, BIOS version, and CPU type.

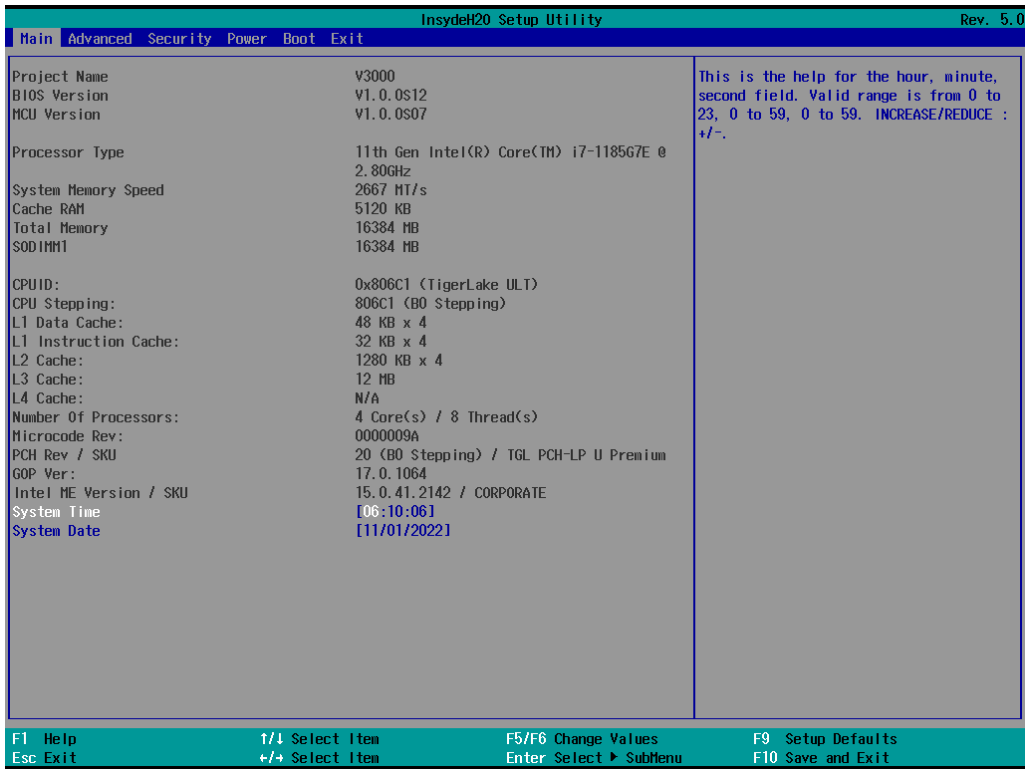

Advanced Settings

Select the Advanced tab in the main menu to open the advanced features screen.

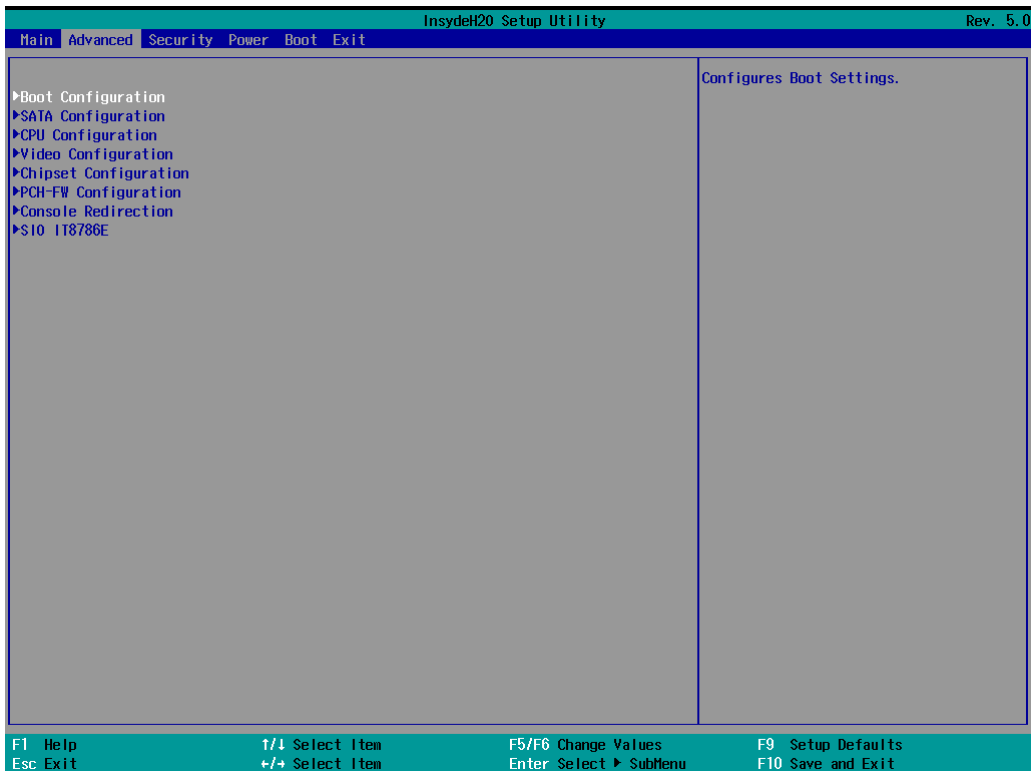

Boot Configuration

The Numlock option allows configuration of the Numlock value.

Options: On (default), Off.

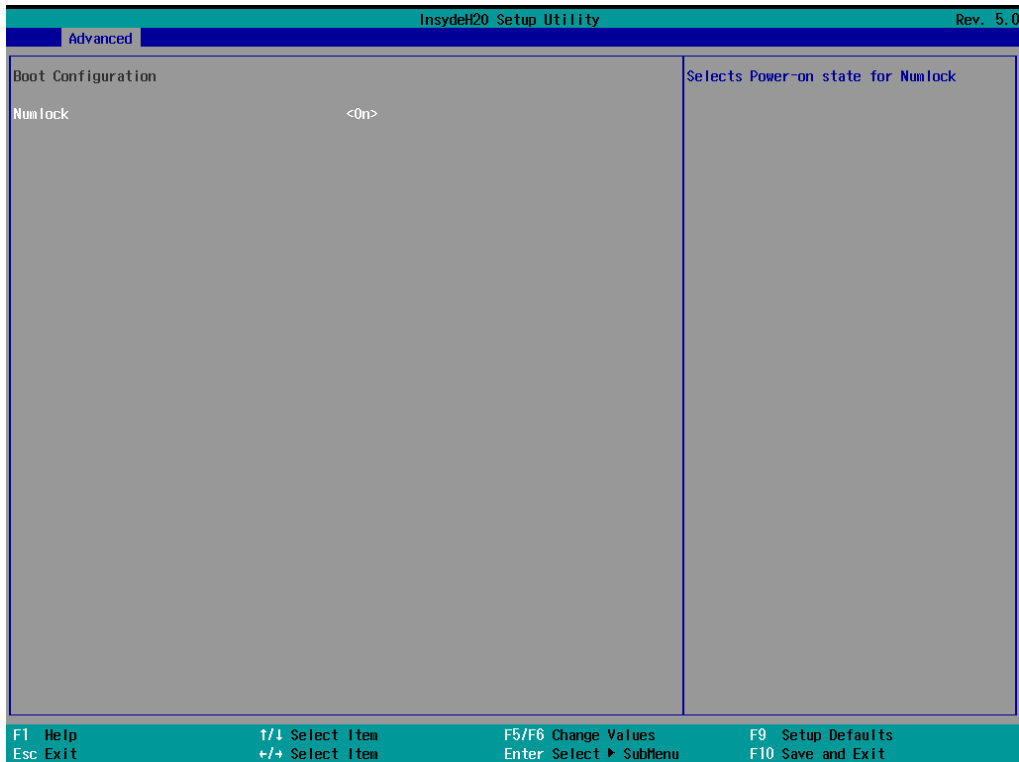

SATA Configuration

These items allow you to select the SATA speed limit and enable or disable the RAID mode.

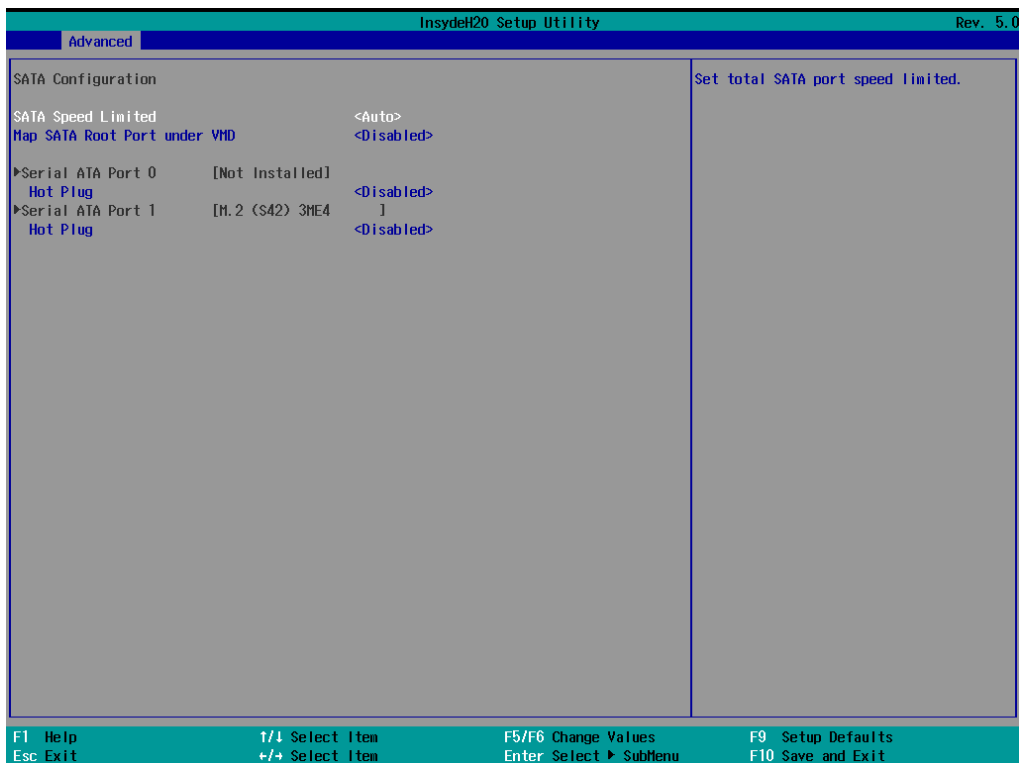

SATA Speed Limited

Options: Auto (default), Gen 1, Gen 2, Gen 3

Map SATA Root Port under VMD

Options: Disabled (default), Enabled

Serial ATA Port

This setting displays information on the installed drives.

SATA Port Hot Plug

This setting allows you to enable/disable hot-plugging capabilities (the ability to remove the drive while the computer is running) that are configured by software for installed storage drives.

Options: Disabled (default), Enabled

RAID

You must set the **Map SATA Root Port under VMD** to **Enabled** to enable redundant array of inexpensive disks (RAID) technology. The device has two SATA interfaces, which support RAID level 0 and RAID level 1.

When using the continuous update policy, changes made to the data on the master drive while the system is not docked are automatically copied to the recovery drive when the system is re-docked. When using the on-request update policy, the master drive data can be restored to a previous state by copying the data on the recovery drive back to the master drive.

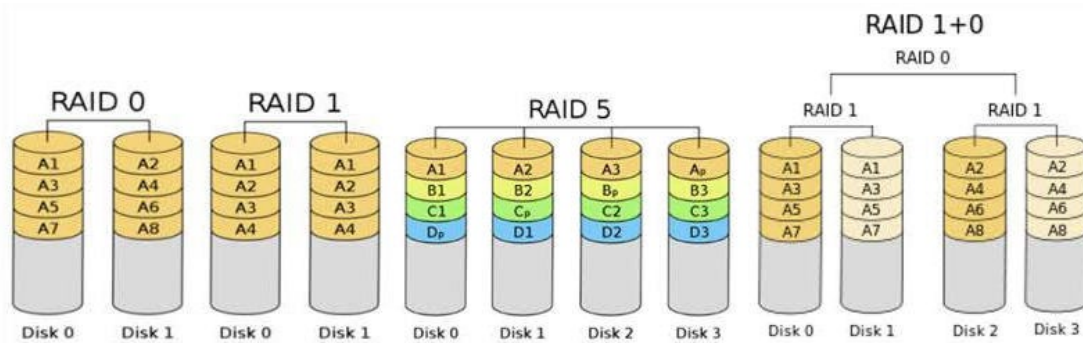

Source: http://en.wikipedia.org/wiki/Standard_RAID_levels

Intel Rapid Storage Technology

This section allows users to configure Intel® Rapid Storage Technology.

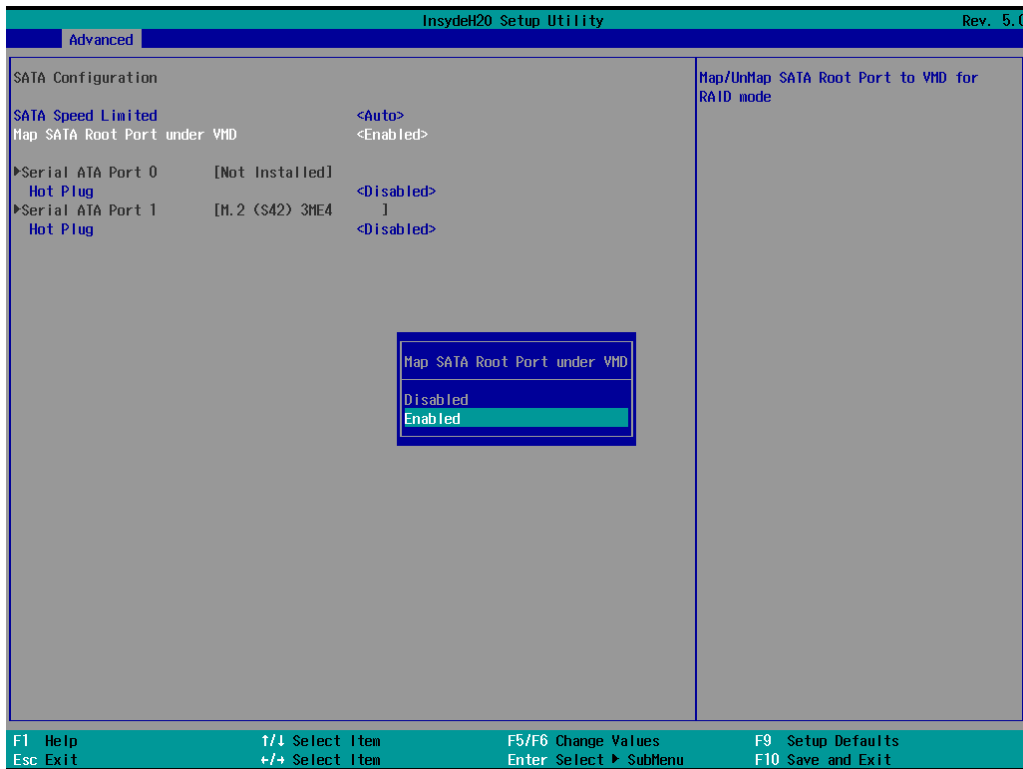

After enabling Map SATA Root Port under VMD, saving changes, and rebooting the system, you can select the Device Manager on BIOS Setup (front page) to configure the Intel Rapid Storage Technology settings.





CPU Configuration

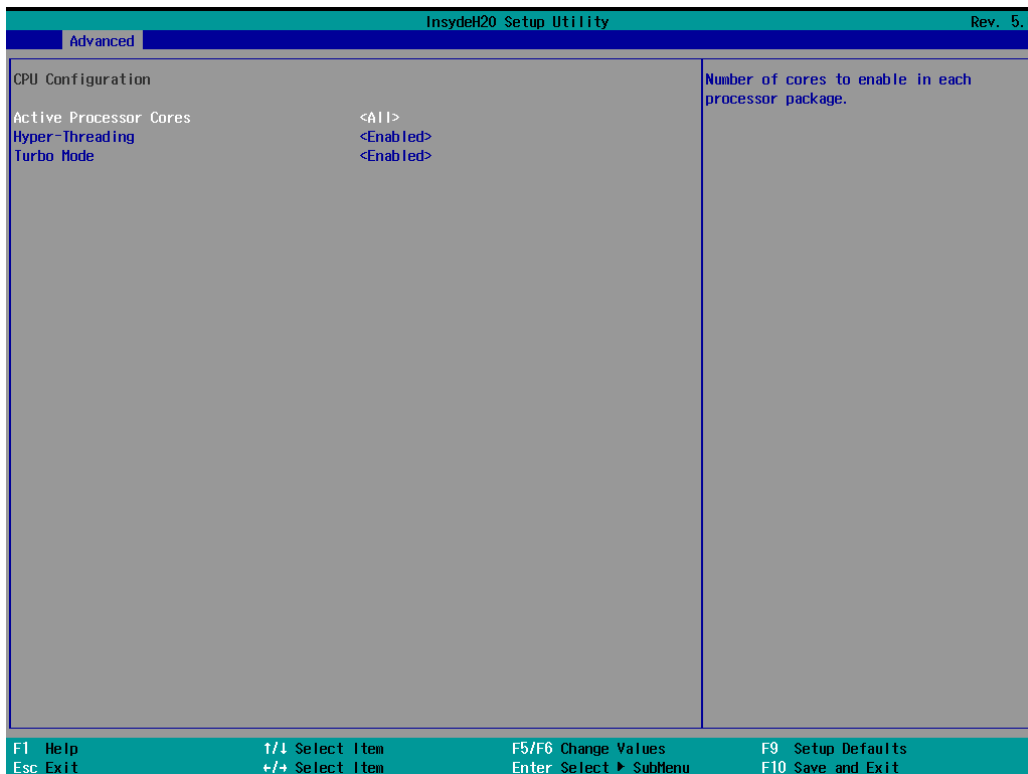

Active Processor Cores

This item indicates the number of cores to enable in each processor package.

Options: All (default),1,2,3

Hyper-Threading

This feature makes the processor resources work more efficiently, enabling multiple threads to run on each core. It also increases processor throughput, improving overall performance on threaded software.

Options: Disabled, Enabled (default)

Turbo Mode

This feature allows you to enable the CPU to overclock or underclock based on system load automatically to save energy or speed up processing.

Options: Disabled, Enabled (default)



NOTE

V3210-TL1-4L-T and V3210-TL1-8L-CT-T do not support the **Turbo Mode** function because Intel® Celeron® 6305E processor does not support it.

Video Configuration

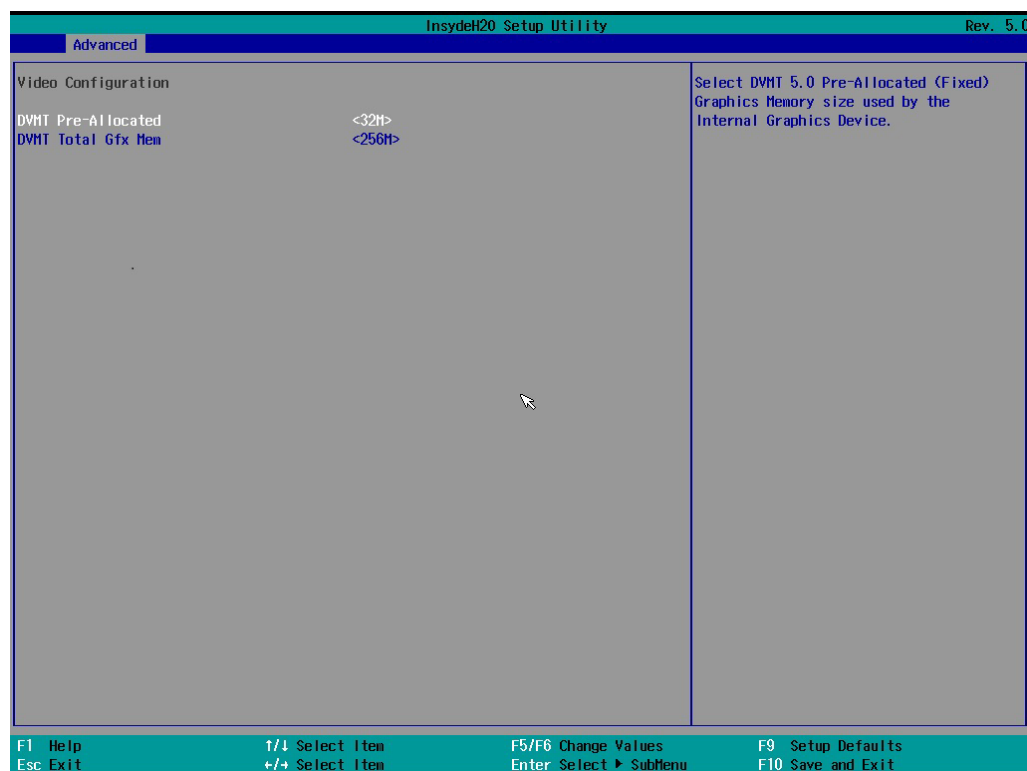

DVMT Pre-Allocated

This item allows you to configure pre-allocated memory capacity for the IGD. Pre-allocated graphics memory is invisible to the operating system.

Options: 32M (default), 64M, 96M, 128M, 160M

DVMT: The amount of video memory your computer has is dependent on the amount of pre-allocated memory set for your system plus the Dynamic Video Memory Technology (DVMT). DVMT dynamically allocates system memory for use as video memory creating the most efficient use of available resources for maximum 2D/3D graphics performance.

DVMT Total Gfx Mem.

This item allows you to configure the maximum amount of memory DVMT will use when allocating additional memory for the internal graphics device.

Options: 256 MB (default), 128 MB, Max.

Chipset Configuration

This item allows you to configure the chipset settings.

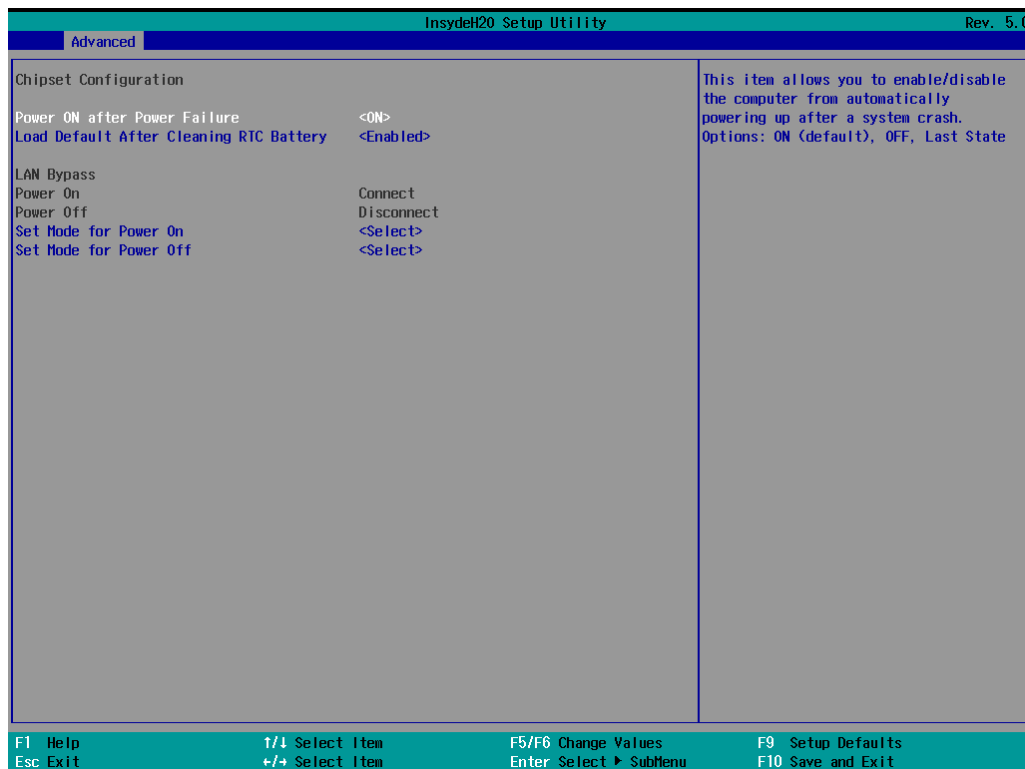

Power ON after Power Failure

This item allows you to enable/disable the computer from automatically powering up after system power is re-enabled.

Options: ON (default), OFF, Last State

Load Default After Cleaning RTC Battery

This item allows you to enable the system to load the default setting when RTC battery loss is detected.

Options: Disabled, Enabled (default)

LAN Bypass

The following options will vary depending on the models you purchase.

Power On: LAN7 and LAN8 are in power on status.

Power Off: LAN7 and LAN8 are in power off status.

Set Mode for Power On

Configure the LAN7 and LAN8 mode when power is on

1. Connect: LAN7 and LAN8 will independently connect to the system
2. ByPass: LAN7 will directly connect with LAN8 without connecting to the system

Set Mode for Power Off:

Configure the LAN7 and LAN8 mode when power is off.

1. Connect: LAN7 and LAN8 will independently connect to the system
2. ByPass: LAN7 will directly connect with LAN8 without connecting to the system
3. Disconnect: LAN7 will not connect with LAN8 and will not connect to the system.

PCH-FW Configuration

This item allows you to configure the PCH-FW settings.

Options:

ME State: Enabled(default), Disabled

ME Unconfig on RTC Clear: Enabled(default), Disabled

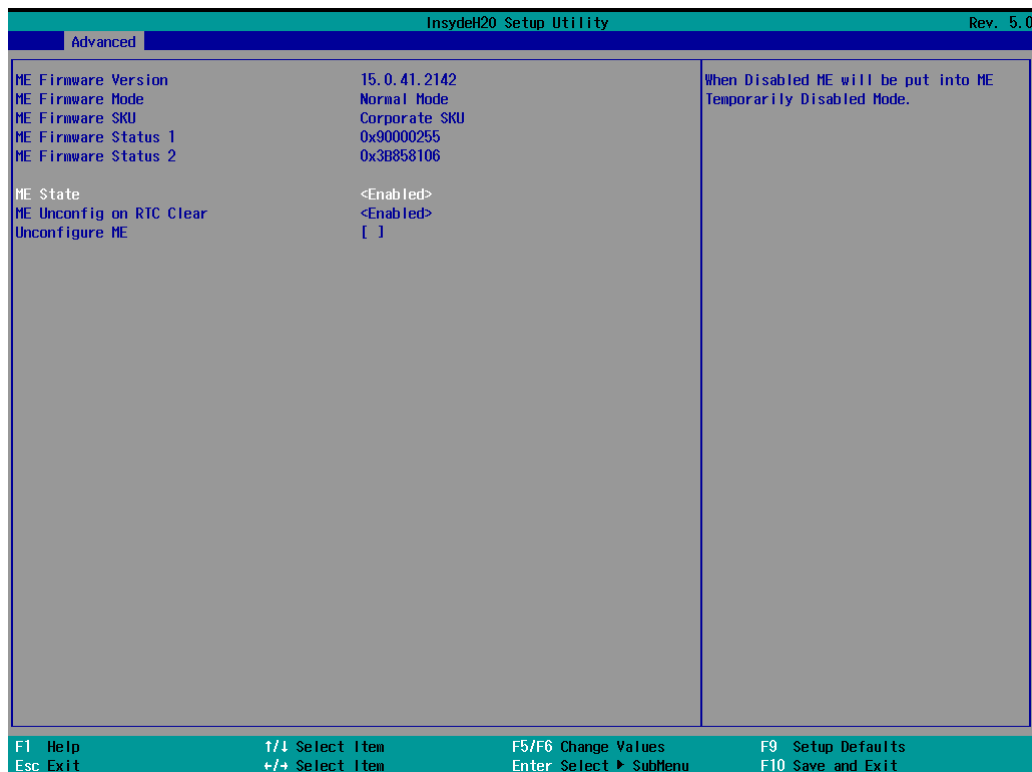

Console Redirection

When the Console Redirection Function is enabled, the console information will be sent to both the display monitor and through the serial port.

Options: Disabled (default), Enabled

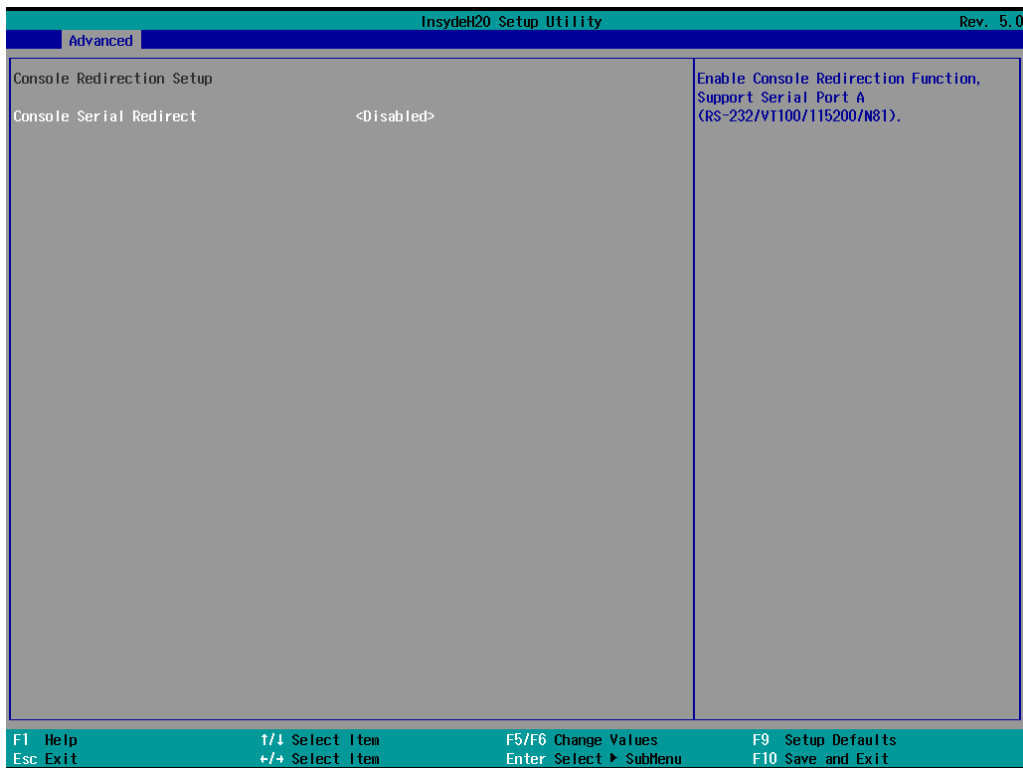

SIO ITE8786E

This section allows users to configure SIO settings.

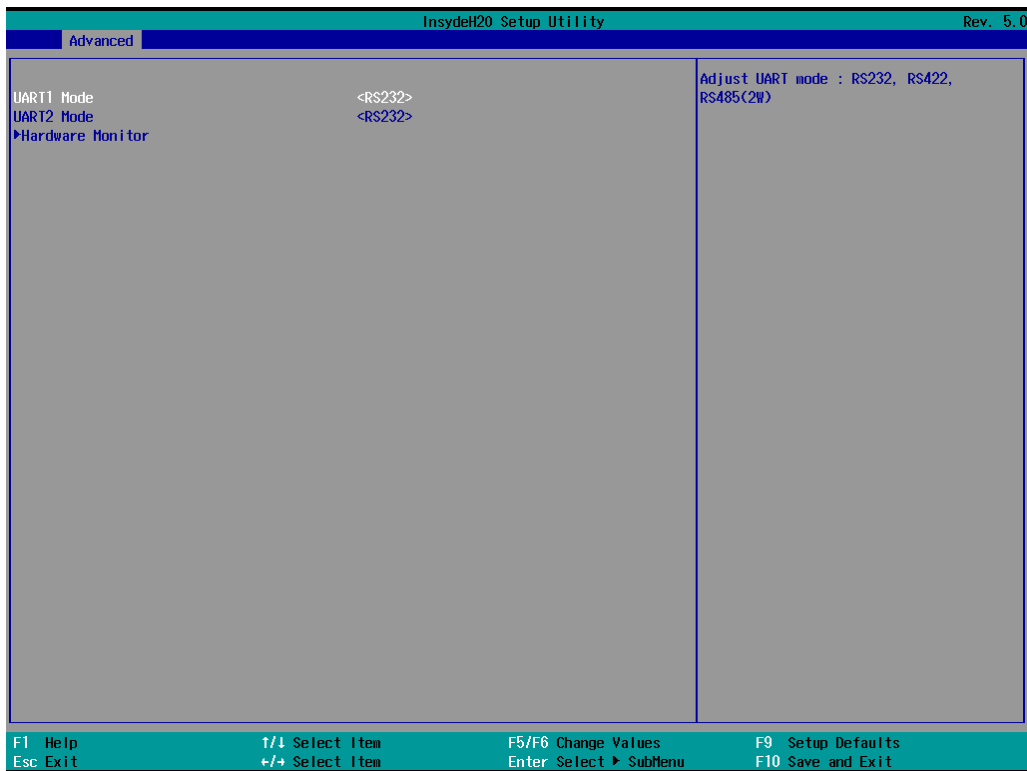

UART1 Mode

This function allows users to configure the UART1 mode.

Option: RS232 (default), RS422, RS485

UART2 Mode

This function allows users to configure the UART2 mode.

Option: RS232 (default), RS422, RS485

Hardware Monitor

This item allows you to view stats such as CPU and system temperature, voltage levels, and other chipset information.

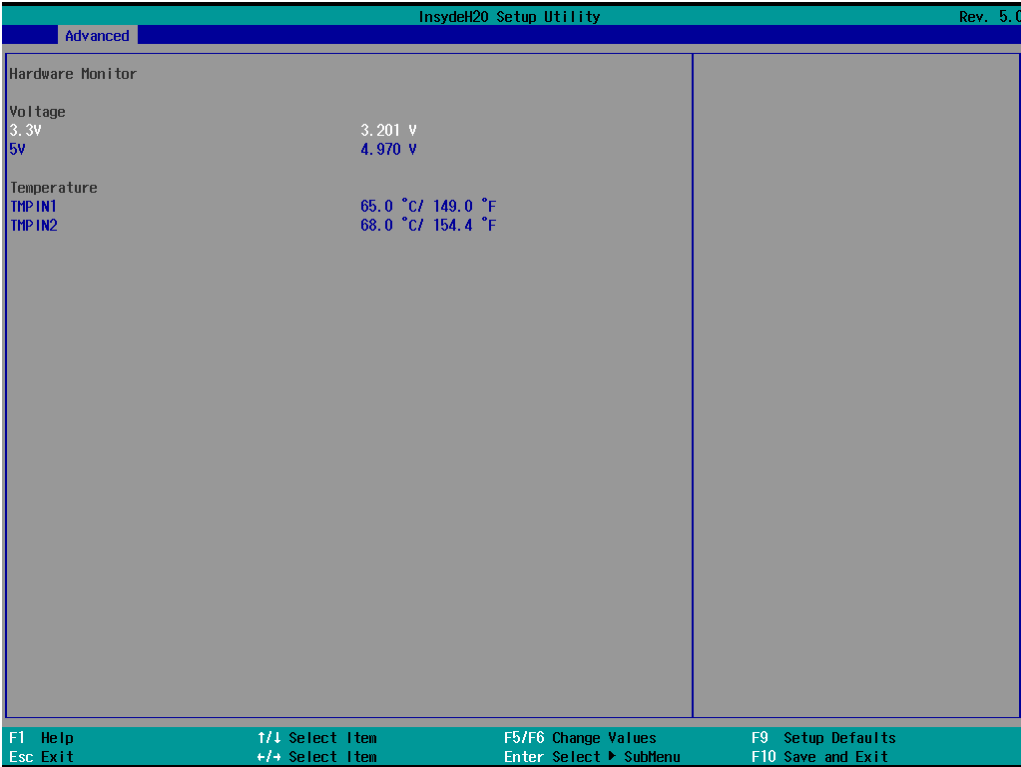

Security Settings

This section allows users to configure security-related settings with a supervisor password and user password.

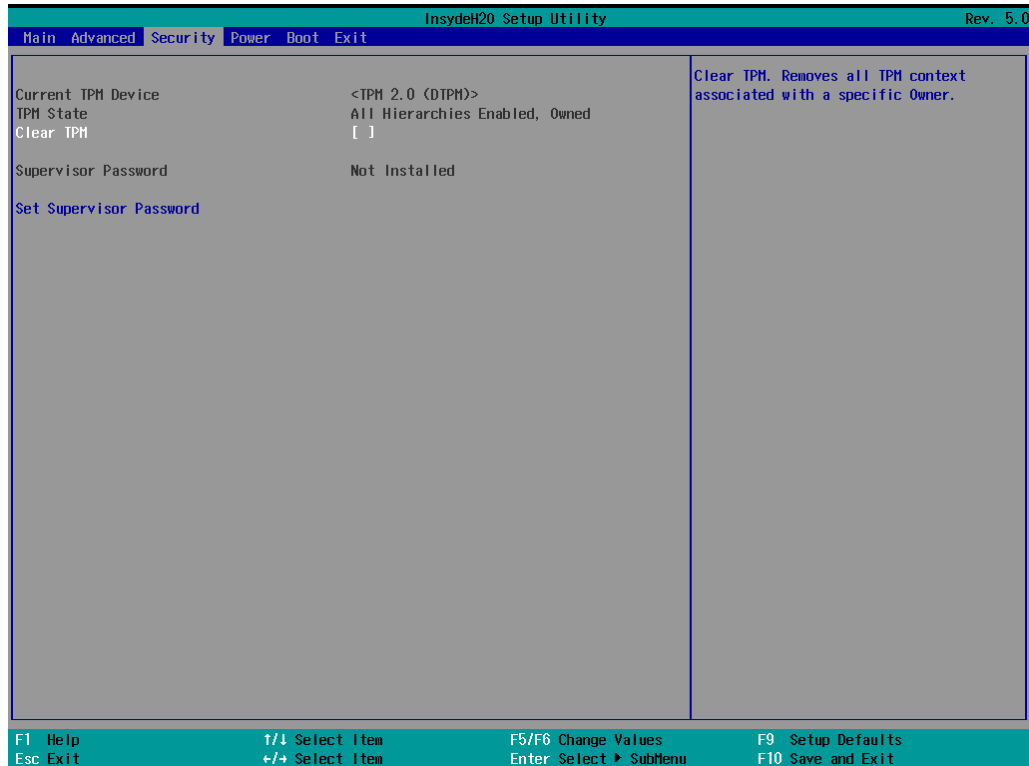

Current TPM Device

This item shows if the system has TPM device and its type.

TPM State

This item allows you view the status of current TPM settings.

Clear TPM

This item allows users to remove all TPM context associated with a specific owner. Select the option and press enter once to display an **x**, which indicates that the Clear TPM option is enabled. The TPM context is clear each time the system boots up.

Set Supervisor Password

This item allows you to set the supervisor password. Select the Set Supervisor Password option and enter the password and confirm the password again.



NOTE

The password must be at least 8 characters.

To delete the password, select the Set Supervisor Password option and enter the old password; leave the new password fields blank, and then press enter.

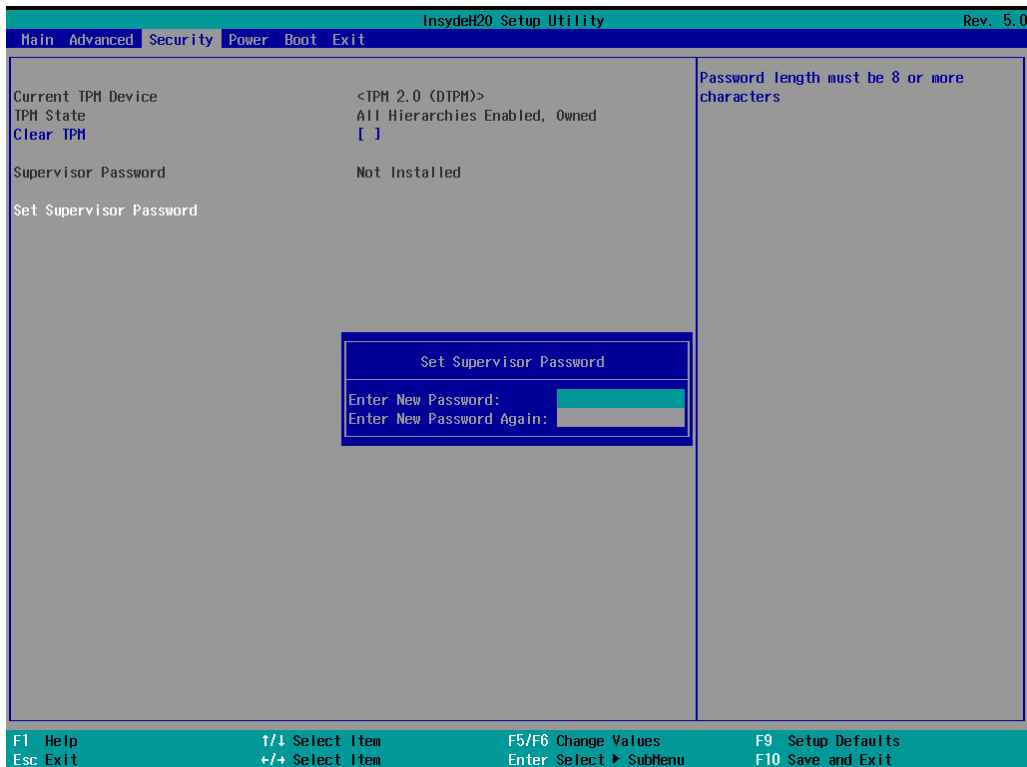

After setting the supervisor password, users can choose when the input password screen should be displayed.

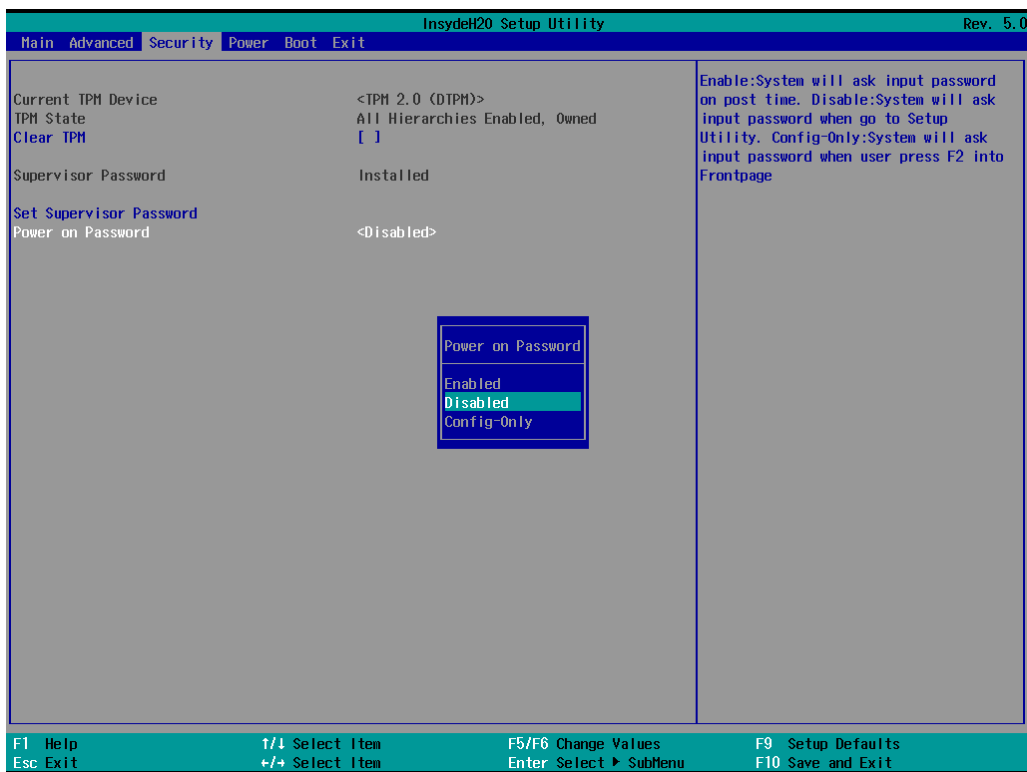

Enabled: System will ask for the password on post time

Disabled: System will ask for the password to go to the setup utility

Config-Only: System will only ask for the password when you select the config (F2) option

Power Settings

The section allows users to configure power settings.

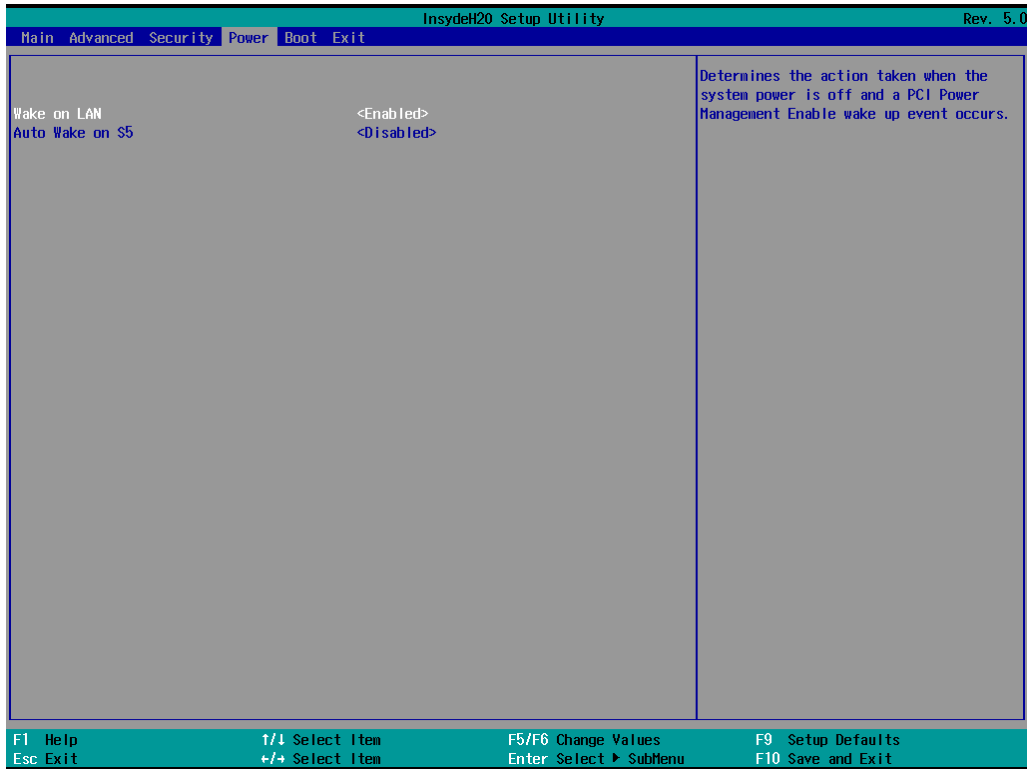

Wake on LAN

This feature is used to wake the system by a LAN device from a remote host.

Options: Enabled (default), Disabled

Auto Wake on S5

This item allows you to configure the computer to wake from S5 status. S5 stands for Soft Off, where the PSU remains engaged but power to all other parts of the system is cut. Auto-wake on S5 schedules a soft-reboot at certain periodic times that may be specified in the BIOS.

Options: Disabled (default); By Every Day (user specifies a regular daily time when the computer will power up); By Day of Month (user specifies a regular day each month when the computer will power up)

Boot Settings

The section allows users to configure boot settings.

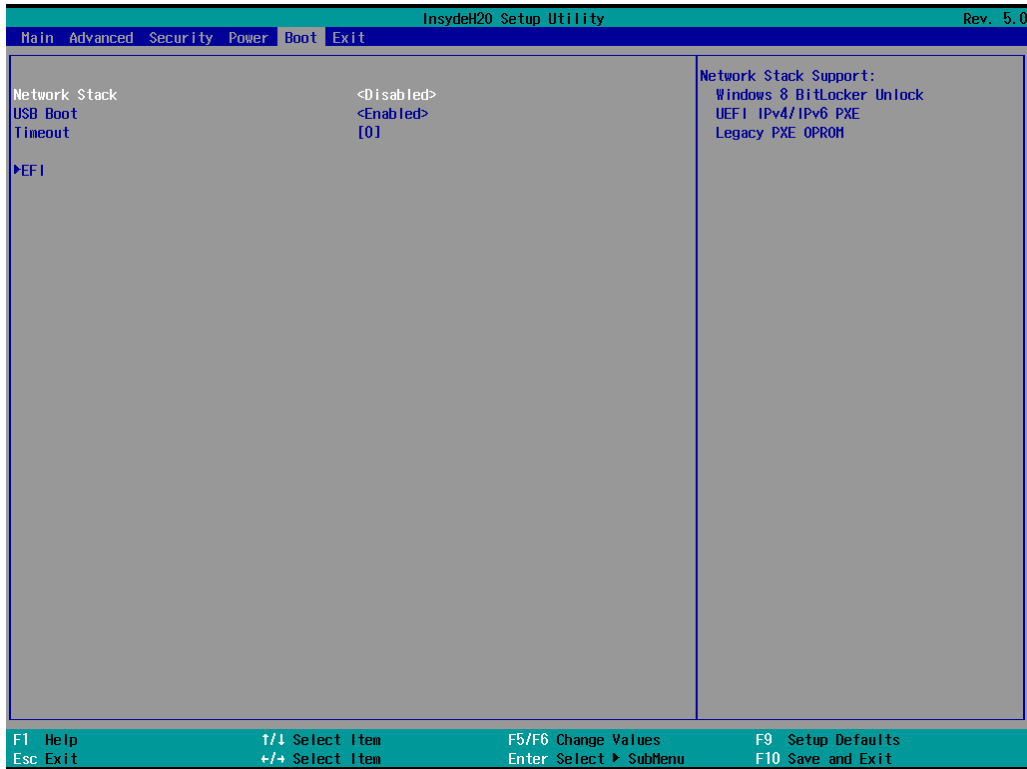

NOTE

If you do not add any storage, you will not see the EFI option.

Network Stack

It deploys an Internet Protocol (IP) stack. The IP stack provides an application library to open/close connections to remote devices and send/receive data between the remote devices.

Options: Disabled (default), Enabled

PXE Boot capability

This item will be shown only when you have enabled the Network Stack.

PXE Booting is booting a system over a network. This item allows users to start PXE over IPv4 or IPv6

Options: Disabled (default), UEFI: IPv4, UEFI: IPv6, UEFI: IPv4/IPv6

USB Boot

Set booting to USB boot devices capability.

Options: Enabled (Default), Disabled

Timeout

This item allows users to set the number of seconds (<10 sec) that the firmware will wait before booting with the original default boot selection.

EFI

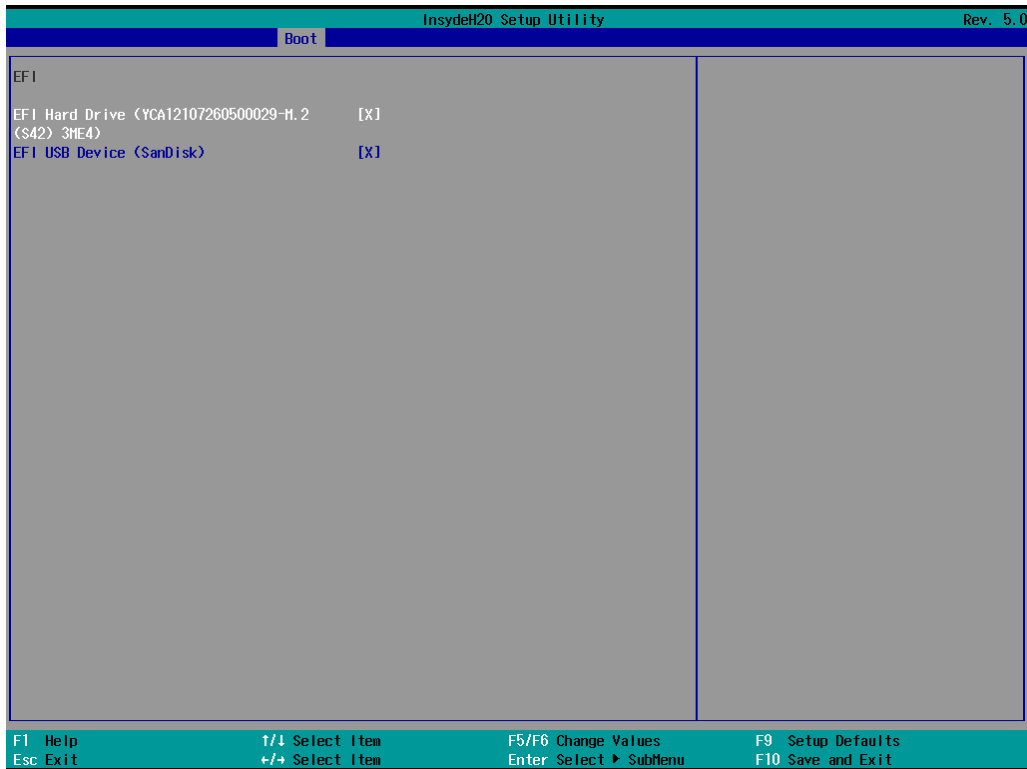

This item allows users to select the boot order. Use F5 (move down) or F6 (move up) to change the value.

Exit Settings

The section allows users to exit the BIOS environment.

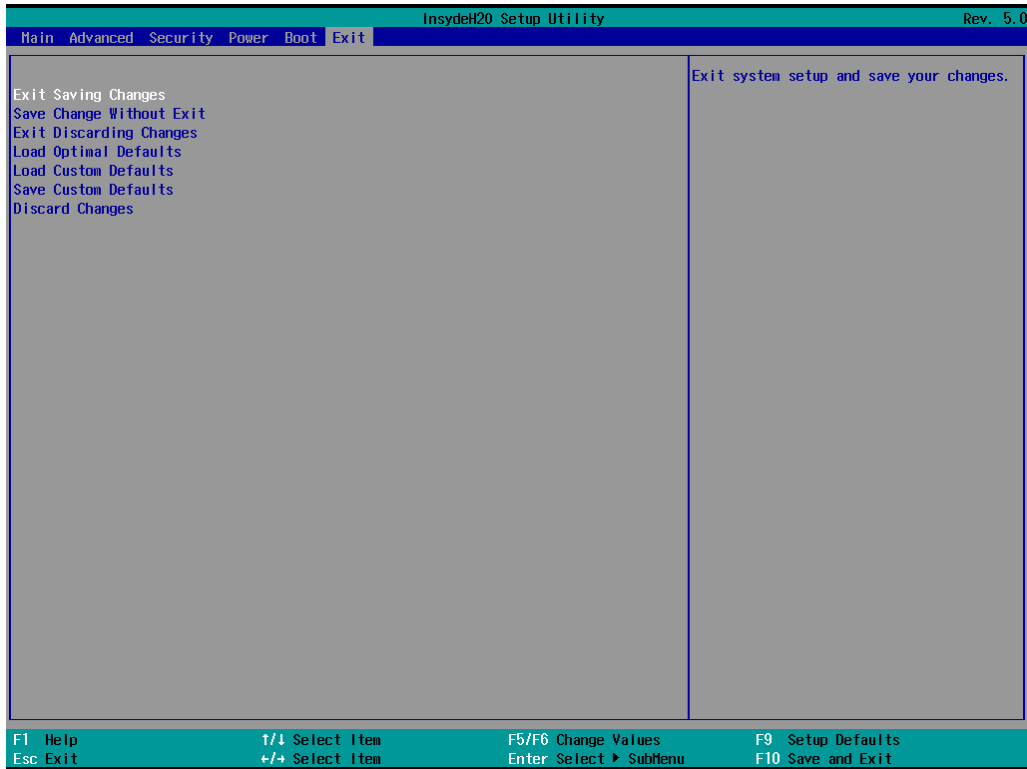

Exit Saving Changes

This item allows you to exit the BIOS environment and save the values you have just configured.

Options: Yes (default), No

Save Change Without Exit

This item allows you to save changes without exiting the BIOS environment.

Options: Yes (default), No

Exit Discarding Changes

This item allows you to exit without saving any changes made to the BIOS.

Options: Yes (default), No

Load Optimal Defaults

This item allows you to revert to the factory default BIOS values.

Options: Yes (default), No

Load Custom Defaults

This item allows you to load custom default values for the BIOS settings.

Options: Yes (default), No

Save Custom Defaults

This item allows you to save the current BIOS values as a "custom default" that may be reverted to at any time by the load custom defaults selection.

Options: Yes (default), No

Discard Changes

This item allows you to discard all settings you have just configured.

Options: Yes (default), No

Enabling AMT



NOTE

The AMT function is NOT supported in models with an Intel® Celeron® or Intel® Core™ i3 CPU.

To enter the BIOS setup utility, press the "F2" key while the system is booting up. The main BIOS Setup screen will appear. Five options will be available:

1. Select Intel® Management Engine BIOS Extension to enter the AMT configuration.

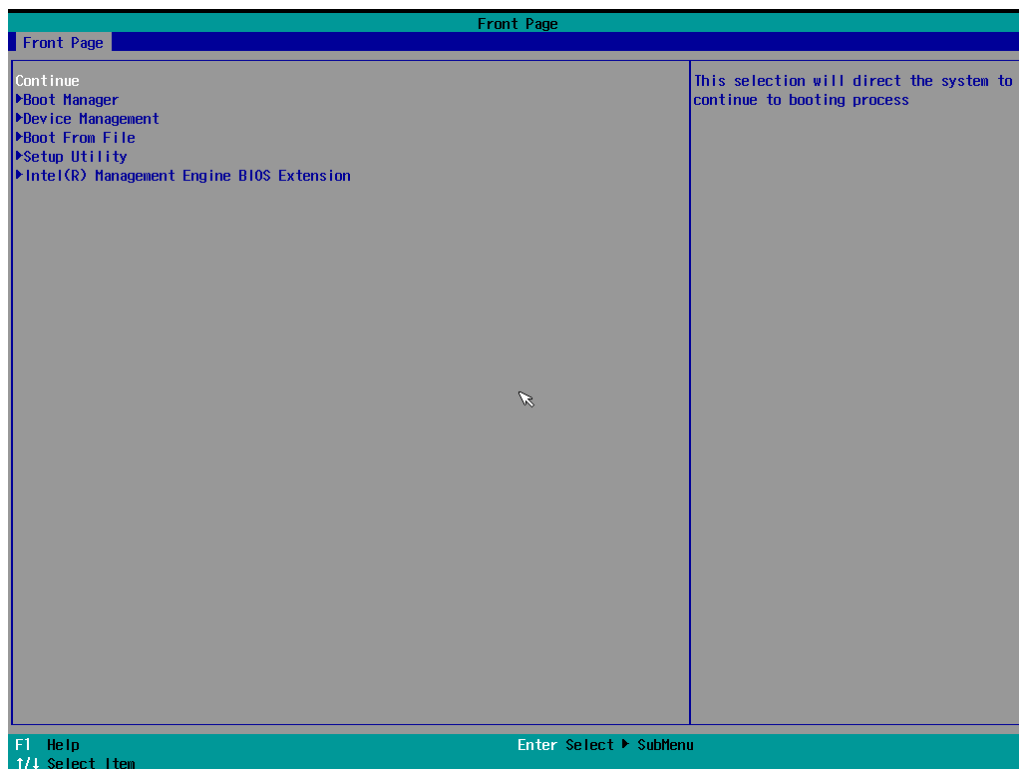

2. Press <Enter> to start the login procedure.

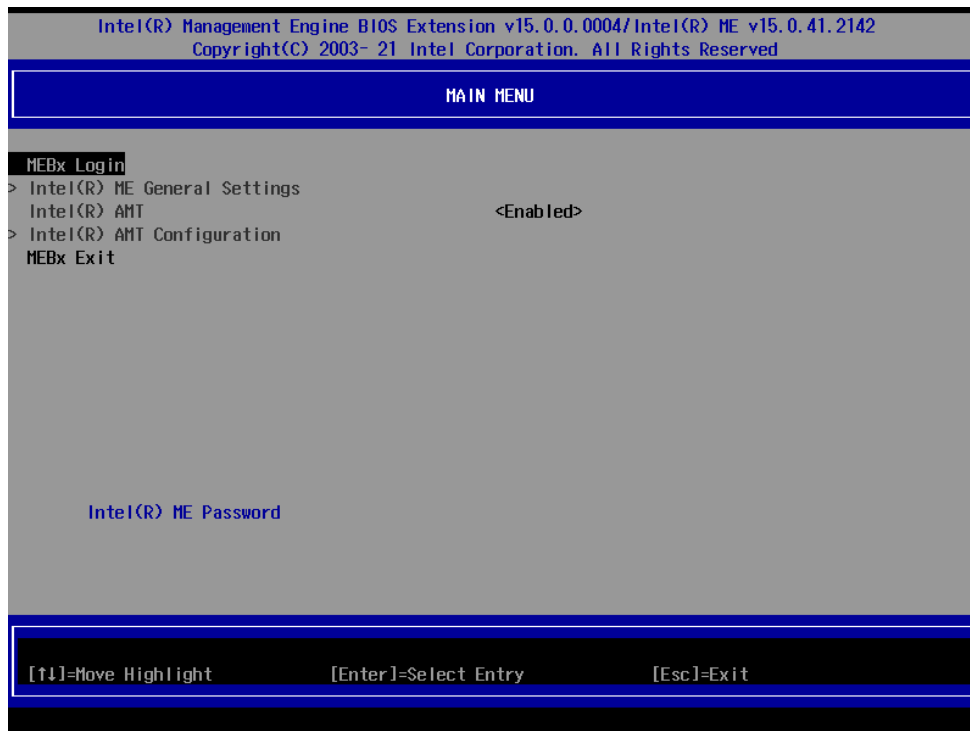

3. Type the default password: admin.

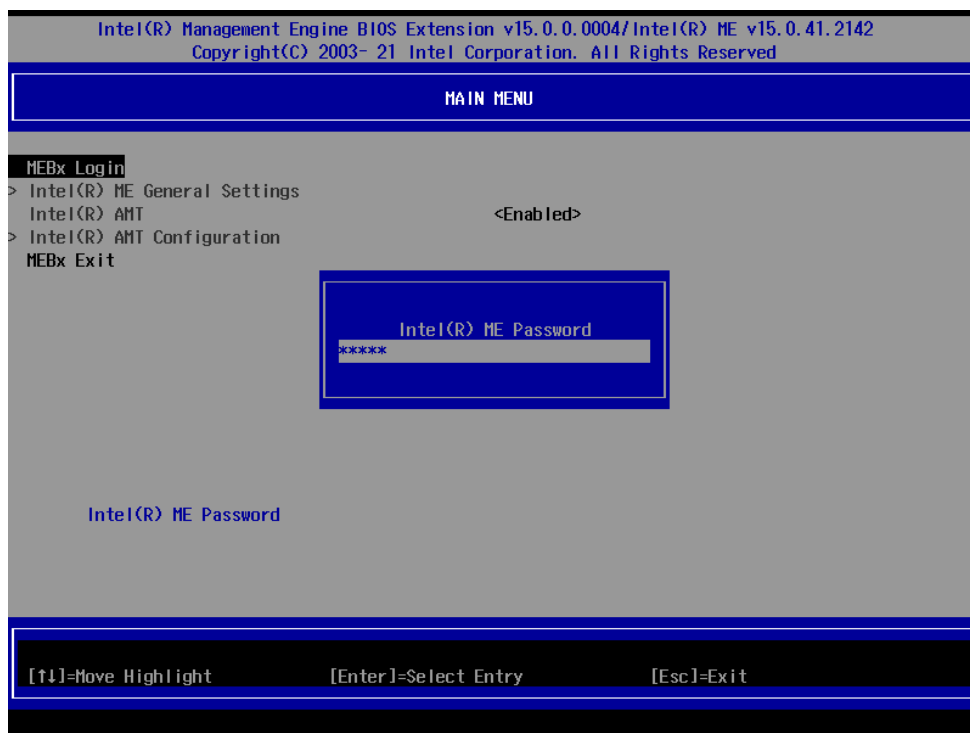

4. Type the new password. It must include both upper-case and lower-case characters, numbers, and special symbols. E.g., Admin'12.

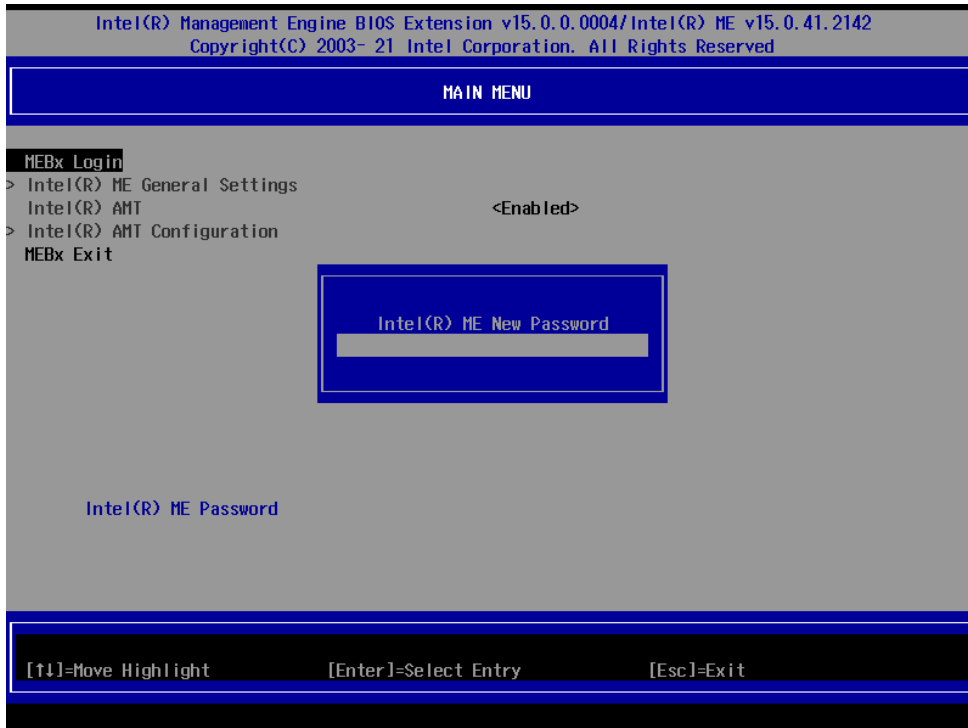

5. Select Intel® AMT Configuration to enable remote access without a local user present for consent, select User Consent, and then select User Opt-in and change the value to None.
6. Set static IP or DHCP by request.

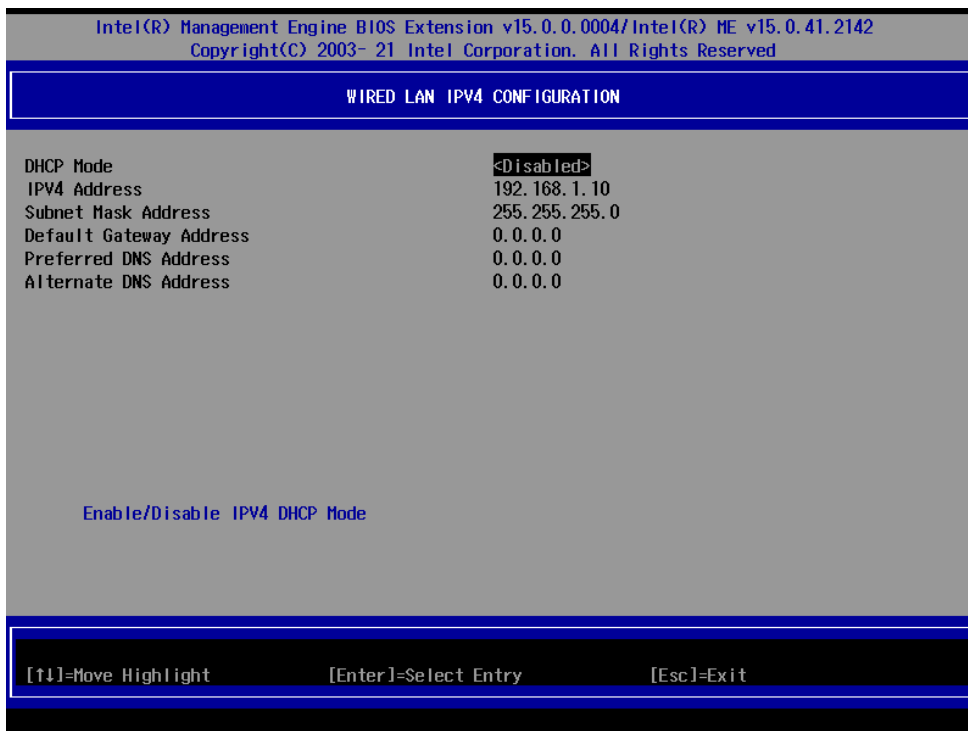

- Set Activate Network Access to enable remote access capability.

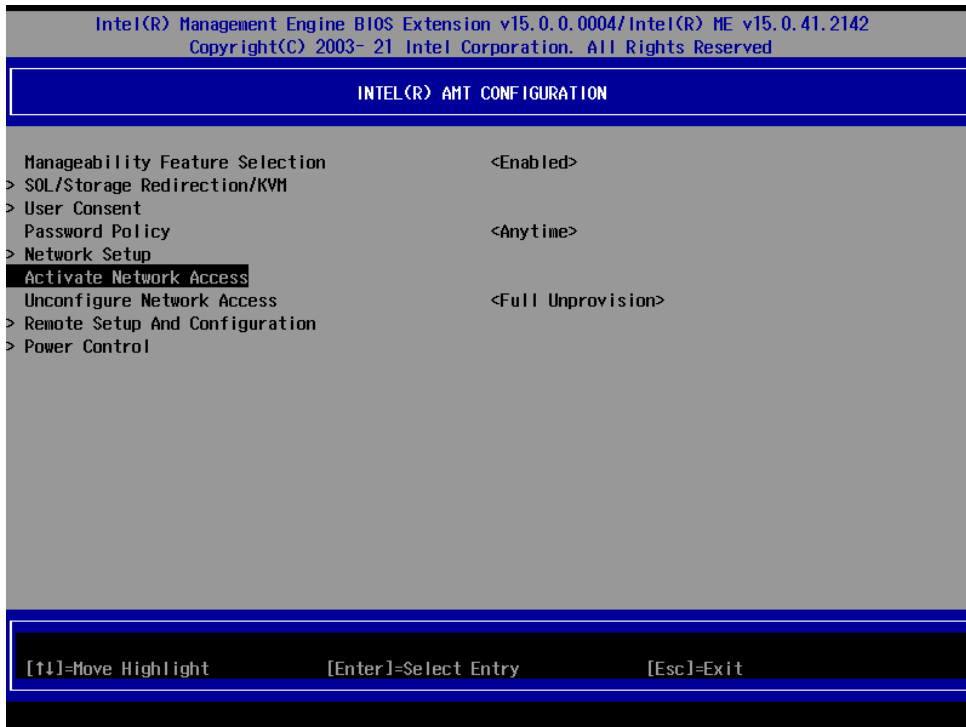

Using AMT

You can use any AMT tool available to run the remote management function using a web browser.

- Type the IP address of your computer as configured in the AMT configuration settings with port 16992.

The AMT logon screen will appear.

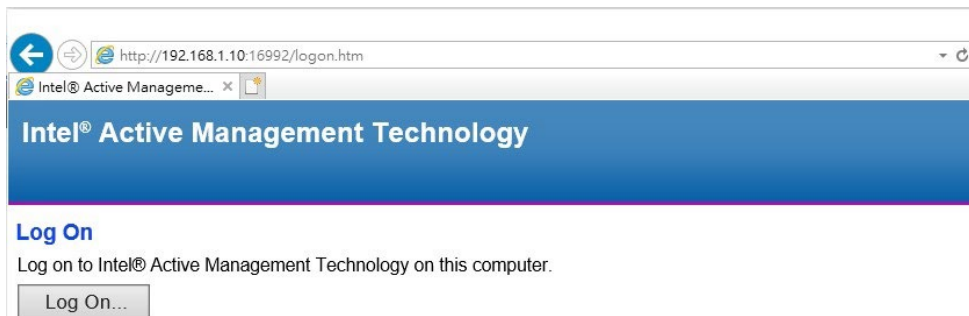

- Click Log On and type the username (admin) and password.

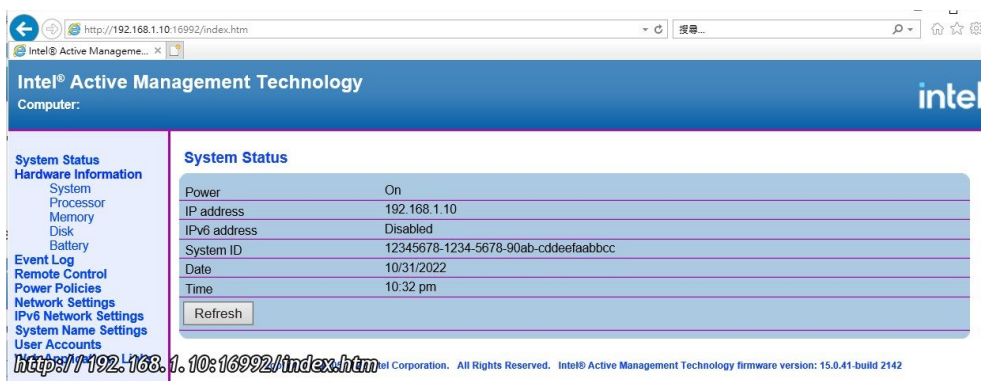



NOTE

The AMT port is LAN1.

For additional details, refer to the Intel® AMT Implementation and Reference Guide at:

https://software.intel.com/sites/manageability/AMT_Implementation_and_Reference_Guide/default.htm?url=WordDocuments%2Faccessingintelamtviathewebuiinterface.htm

Administering Secure Boot

Press F2 to go to the Administer Secure Boot.



Secure Boot helps computers resist attacks and infection from malware. The feature defines an interface between the operating system and BIOS. It detects tampering with boot loaders, key operation system files, and unauthorized option ROMs by validating their digital signatures.

Enabling UEFI Secure Boot

Set **Restore Secure Boot to Factory Settings** under **Administer Secure Boot** to **Enable** and press F10 to save and exit.



Moxa includes the Microsoft key in the BIOS by default; if the system does boot up with a non-Windows OS, use the instructions in the following sections.

Enroll EFI Image

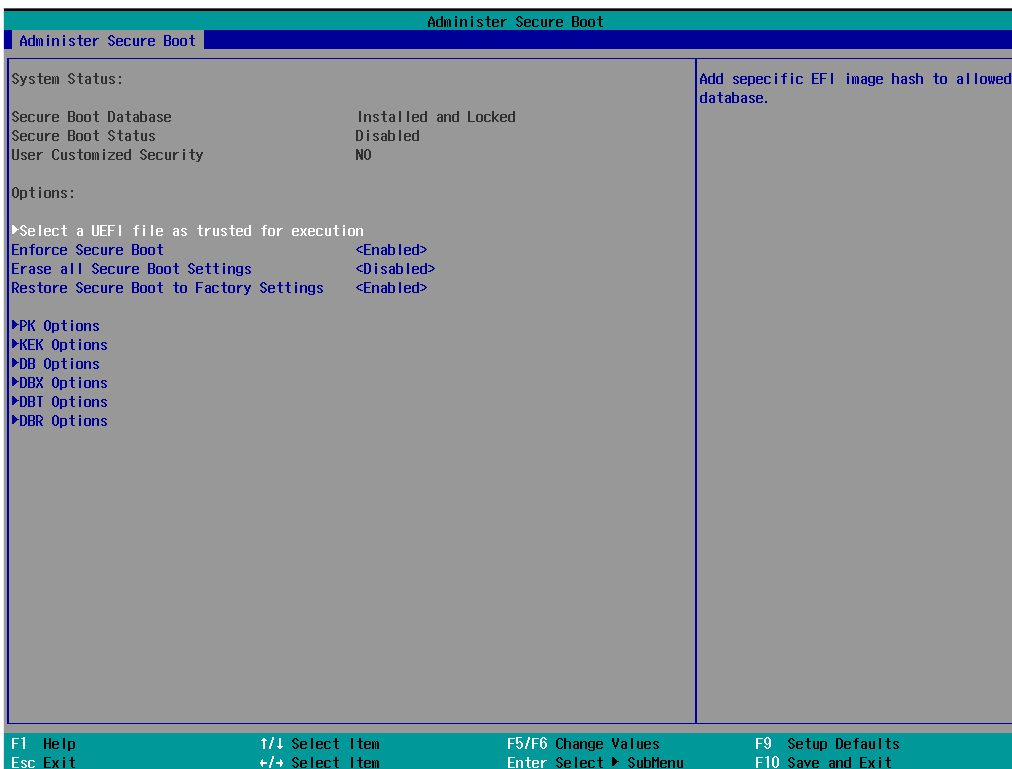

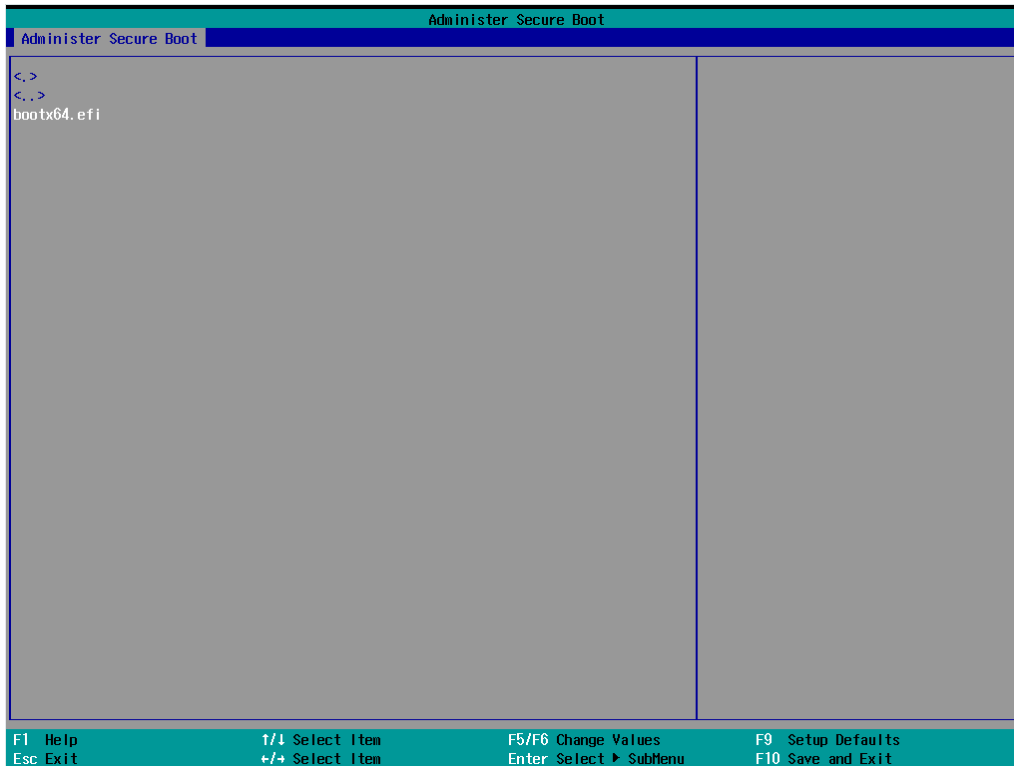

Enter **Administer Secure Boot** once again and choose **Select a UEFI file as trusted for execution**. Enter the name of the loader into the database followed by the UEFI standard \EFI\BOOT\BOOT{machine type short-name}. For example, efi\boot\BootX64.efi, Debian (EFI\debian\grubx64.efi), Suse (EFI\opensuse\grubx64.efi)

Enroll Customer Key

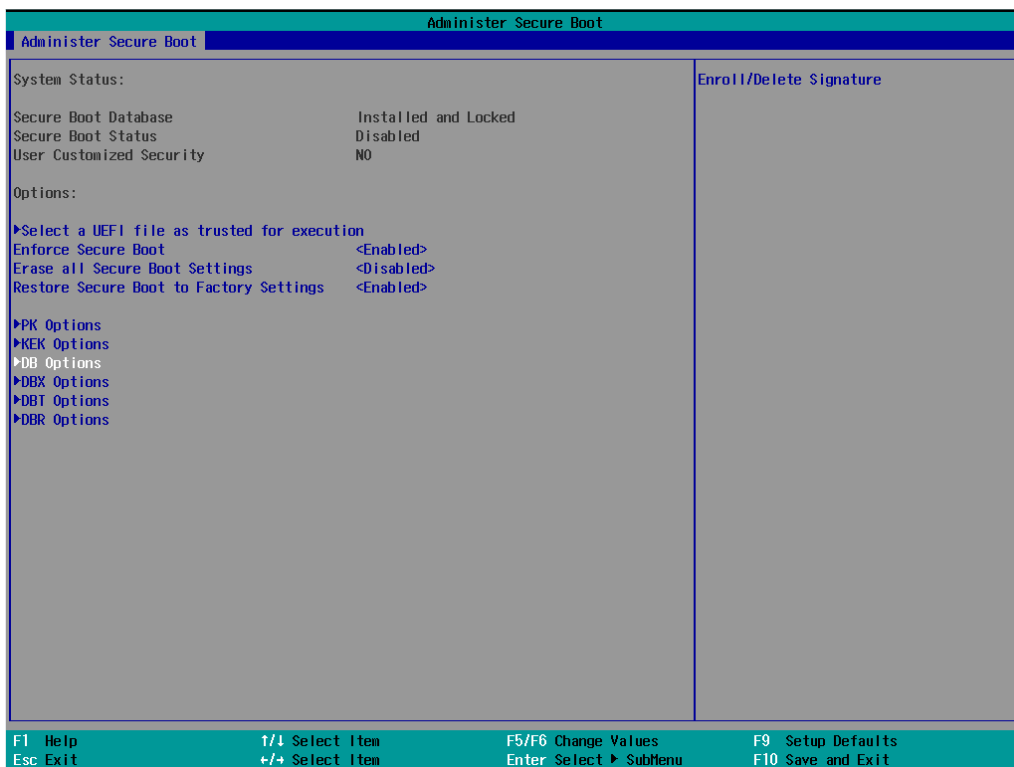

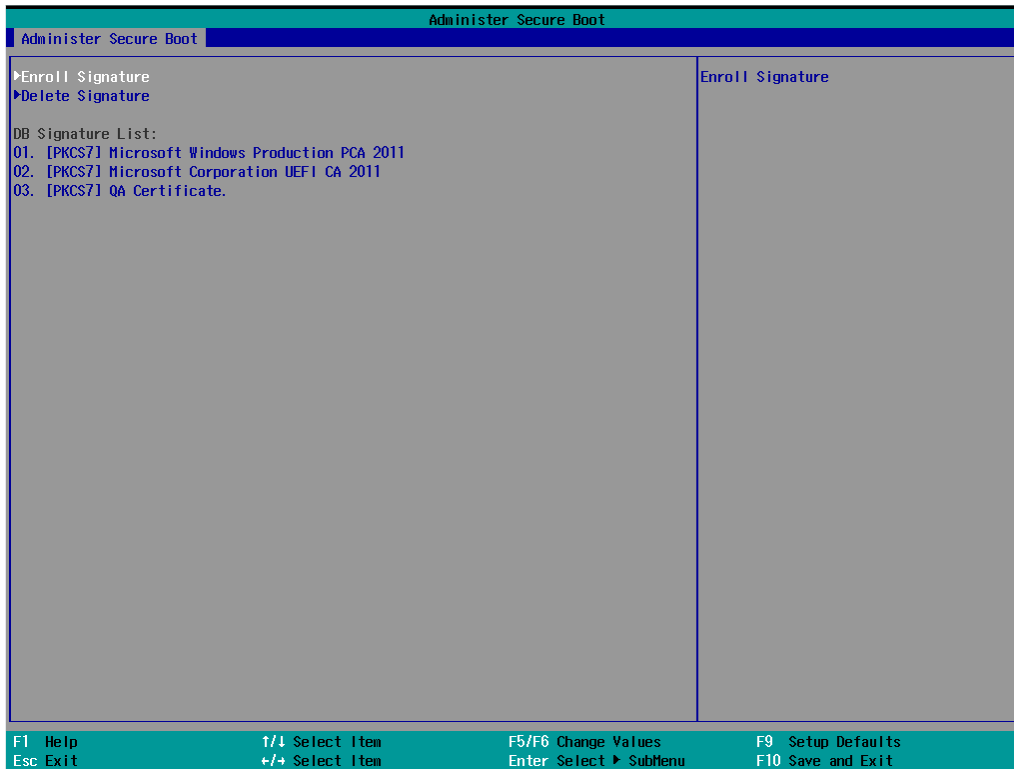

Enter "DB OPTION" and enroll your key. Ensure that your key is CRT format and uses RSA 2048 or better.

Upgrading the BIOS

This section describes how to upgrade the BIOS on your computer.



NOTE

It is possible to permanently damage the computer when upgrading the BIOS. We strongly recommend that you contact Moxa's technical support staff for assistance to obtain all the necessary tools and the most current advice before attempting to upgrade the BIOS on any Moxa device.

Step 1: Create a Bootable USB Disk

Before upgrading the BIOS, you must create a bootable USB drive as a system boot device for use in the future.

1. Insert a USB disk in the computer's USB drive.
2. Search for "format" and select Create and format hard disk partitions.

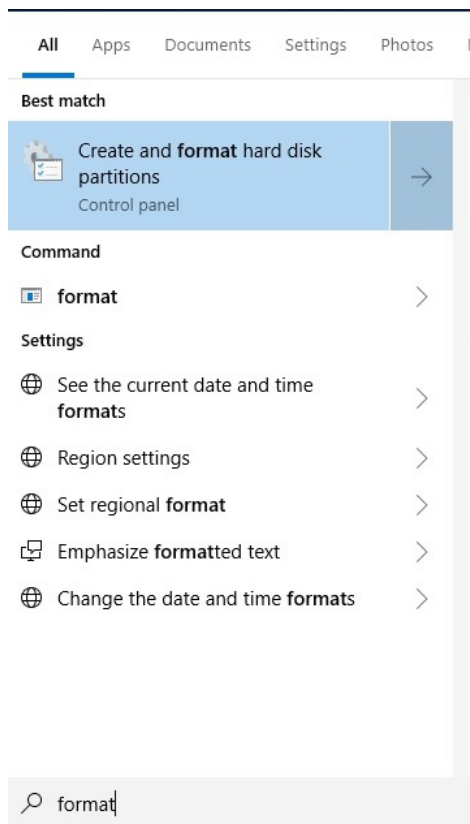

3. Right-click on the USB disk item and select Format.

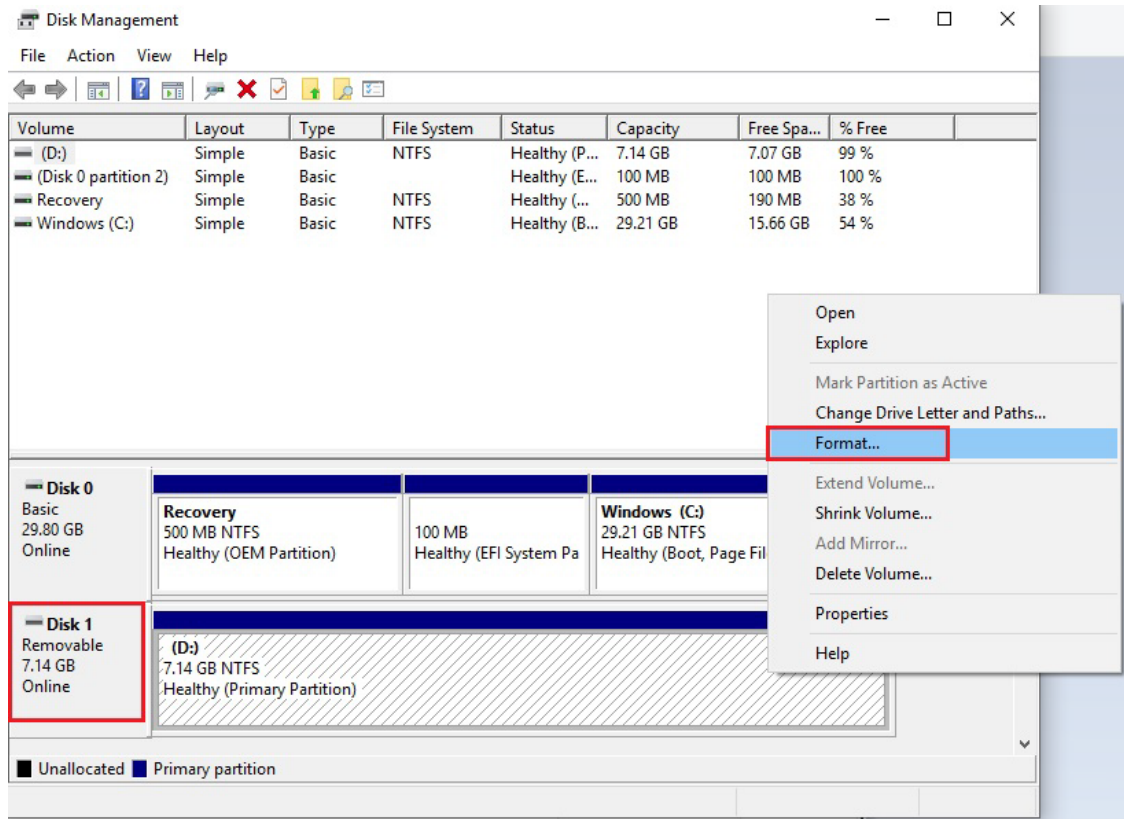

4. Select FAT32 and click OK to start formatting the disk.

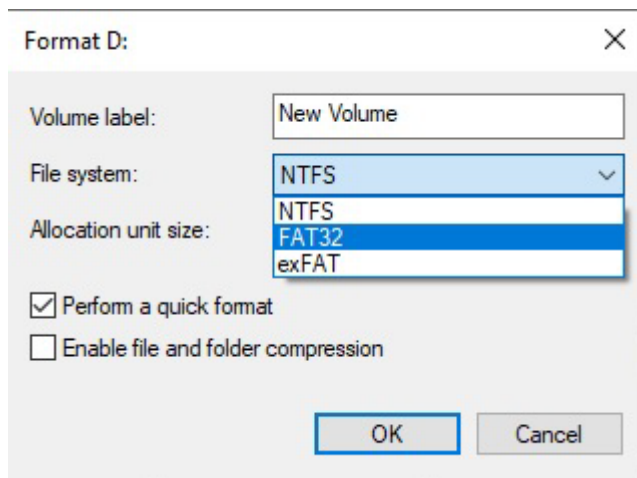

Step 2: Prepare the Upgrade File

You must use the BIOS upgrade installation file to upgrade the BIOS. Contact Moxa's technical department for assistance. The BIOS upgrade file includes an efi folder and an **xxxx.efi** file. Copy the efi folder and **xxxx.efi** file to the bootable USB disk.

Step 3: Run the Upgrade Program on Your Computer

1. Reboot the computer with the boot disk and press F2 to go to the Boot Manager.

If the BIOS cannot recognize the USB drive as the boot-up device, the USB drive might not have a partition table. Use the Windows command line tool **diskpart** to rebuild the partition table.

2. Select the USB Disk.



The screen will switch to the SHELL environment.

3. Type `fs0:`, go to the directory where the upgrade file is located, and type `xxxxxx.efi` (the file name is based on the upgrade file from Moxa).

```
Device mapping table
fs0      :Removable HardDisk - Alias hd24s0b blk0
         PciRoot(0x0)/Pci(0x14,0x0)/USB(0x12,0x0)/HD(1,MBR,0x00DD3D80,0x3F,0xEB5FC1)
blk0     :Removable HardDisk - Alias hd24s0b fs0
         PciRoot(0x0)/Pci(0x14,0x0)/USB(0x12,0x0)/HD(1,MBR,0x00DD3D80,0x3F,0xEB5FC1)
blk1     :Removable BlockDevice - Alias (null)
         PciRoot(0x0)/Pci(0x14,0x0)/USB(0x12,0x0)
hd24s0b  :Removable HardDisk - Alias fs0 blk0
         PciRoot(0x0)/Pci(0x14,0x0)/USB(0x12,0x0)/HD(1,MBR,0x00DD3D80,0x3F,0xEB5FC1)

Shell> fs0:
fs0:\> xxxxxx.efi
```

- Wait until the upgrade procedure is completed.



ATTENTION

Do NOT switch off the power supply during the BIOS upgrade, since doing so may cause the system to crash.

```

Insyde H20FFT (Flash Firmware Tool) Version (SEG) 200.00.00.13
Copyright (C) 2020 Insyde Software Corp. All Rights Reserved.

Loading New BIOS Image File: Done

Current BIOS Model Name: V3000
New BIOS Model Name: V3000
Current BIOS Version: V1.0.0S12
New BIOS Version: V1.0.0S12

Common Region:00 StartAddr:0xFE000000 EndAddr:0xFE000FFF
Common Region:01 StartAddr:0xFF400000 EndAddr:0xFFFFFFFF
Updating Block at FE871000h
0%      25%      50%      75%      100%
[Progress bar showing 26% completion]
26%

```

When the upgrade is finished, the computer will automatically reboot.

You can check the BIOS version on the Main page to confirm that the upgrade is completed. If the system has more than one boot device, you will see the same number of **fsx** items (x represents the number).

```

EFI Shell version 2.50 [22281.4149]
Current running mode 1.1.2
Device mapping table
fs0 :HardDisk - Alias hd33e0a2 blk0
      PciRoot(0x0)/Pci(0x17,0x0)/Sata(0x4,0x0,0x0)/HD(2,GPT,0AC3B829-99B0-4FDE-844D-8A10C1D55C6C,0xFA000,0x32000)
fs1 :Removable HardDisk - Alias hd25r0b blk1
      PciRoot(0x0)/Pci(0x14,0x0)/USB(0x11,0x0)/HD(1,MBR,0x00DD3D80,0x3F,0xEB5FC1)
fs2 :Removable BlockDevice - Alias f25s0 blk2
      PciRoot(0x0)/Pci(0x14,0x0)/USB(0x12,0x0)
blk0 :HardDisk - Alias hd33e0a2 fs0
      PciRoot(0x0)/Pci(0x17,0x0)/Sata(0x4,0x0,0x0)/HD(2,GPT,0AC3B829-99B0-4FDE-844D-8A10C1D55C6C,0xFA000,0x32000)
blk1 :Removable HardDisk - Alias hd25r0b fs1
      PciRoot(0x0)/Pci(0x14,0x0)/USB(0x11,0x0)/HD(1,MBR,0x00DD3D80,0x3F,0xEB5FC1)
blk2 :Removable BlockDevice - Alias f25s0 fs2
      PciRoot(0x0)/Pci(0x14,0x0)/USB(0x12,0x0)
blk3 :HardDisk - Alias (null)
      PciRoot(0x0)/Pci(0x17,0x0)/Sata(0x4,0x0,0x0)/HD(1,GPT,5796BAEF-EC3F-447F-B4F1-21EB08DC5D57,0x800,0xF9800)
blk4 :HardDisk - Alias (null)
      PciRoot(0x0)/Pci(0x17,0x0)/Sata(0x4,0x0,0x0)/HD(3,GPT,7C8FF3C6-53E8-4CF9-8141-65DF7EF04399,0x12C000,0x8000)
blk5 :HardDisk - Alias (null)
      PciRoot(0x0)/Pci(0x17,0x0)/Sata(0x4,0x0,0x0)/HD(4,GPT,1AABAECB-BE17-4C27-AF60-E6C69977AC02,0x134000,0x3A6E800)
blk6 :BlockDevice - Alias (null)
      PciRoot(0x0)/Pci(0x17,0x0)/Sata(0x4,0x0,0x0)
blk7 :Removable BlockDevice - Alias (null)
      PciRoot(0x0)/Pci(0x14,0x0)/USB(0x11,0x0)

```

- Go to each fsx (x stands for the number) and type ls to view the content of the boot device.

If you find an upgrade file, run it.

```

fs0:\> fs1:
fs1:\> ls
Directory of: fs1:\

06/27/19 11:43a <DIR>          16,384 efi
06/13/19 11:10a             17,974,704 820C100S16 efi
1 File(s) 17,974,704 bytes
1 Dir(s)

```

A. Regulatory Approval Statement



This device complies with part 15 of the FCC Rules. Operation is subject to the following two conditions: (1) This device may not cause harmful interference, and (2) this device must accept any interference received, including interference that may cause undesired operation.

Class A: FCC Warning! This equipment has been tested and found to comply with the limits for a Class A digital device, pursuant to part 15 of the FCC Rules. These limits are designed to provide reasonable protection against harmful interference when the equipment is operated in a commercial environment. This equipment generates, uses, and can radiate radio frequency energy and, if not installed and used in accordance with the instruction manual, may cause harmful interference to radio communications. Operation of this equipment in a residential area is likely to cause harmful interference in which case the user will be required to correct the interference at his own expense.



European Community



WARNING

This is a class A product. In a domestic environment this product may cause radio interference in which case the user may be required to take adequate measures.